

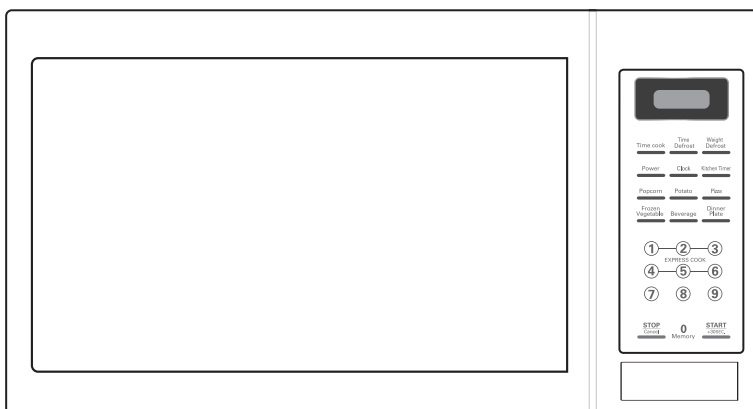

30L Microwave Oven
INSTRUCTION MANUAL

Model: 747300



**Read these instructions carefully
before using your microwave oven,
and retain them for future reference.**

PRECAUTIONS TO AVOID POSSIBLE EXPOSURE TO EXCESSIVE MICROWAVE ENERGY

- (a) Do not attempt to operate this oven with the door open since this can result in harmful exposure to microwave energy. It is important not to break or tamper with the safety interlocks.
- (b) Do not place any object between the oven front face and the door or allow soil or cleaner residue to accumulate on sealing surfaces.
- (c) **WARNING:** If the door or door seals are damaged, the oven must not be operated until it has been repaired by a competent person.

WARNING

If the appliance is not maintained in a good state of cleanliness, its surface could be degraded and affect the lifespan of the oven and safety of usage.

Specifications

Model:	747300
Rated Voltage:	240V~ 50Hz
Rated Input Power(Microwave):	1450 W
Rated Output Power(Microwave):	900 W
Oven Capacity:	30 L
Turntable Diameter:	∅ 315 mm
External Dimensions:	520mm x 430mm x 325.7mm
Net Weight:	Approx. 16kg

IMPORTANT SAFETY INSTRUCTIONS - WARNING

To reduce the risk of fire, electric shock, injury to persons or exposure to excessive microwave oven energy when using your appliance, please follow basic precautions including the following:

1. Liquids and other foods must not be heated in sealed containers since they are liable to explode.
2. It is hazardous for anyone other than a competent person to carry out any service or repair operation that involves the removal of a cover which gives protection against exposure to microwave energy.
3. Only allow children to use the oven without supervision when adequate instructions have been given so that the child is able to use the oven in a safe way and understand the hazards of improper use.
4. Only use utensils suitable for use in microwave ovens.
5. The oven should be cleaned regularly and any food deposits should be removed.
6. Read and follow the specific precautions to avoid possible exposure to excessive microwave energy.
7. When heating food in plastic or paper containers, keep an eye on the oven due to the possibility of ignition.
8. If smoke is observed, switch off or unplug the appliance and keep the door closed in order to stifle any flames.
9. Do not overcook food.
10. Do not use the oven cavity for storage purposes. Do not store items (food or otherwise) inside the oven.
11. Remove wire twist-ties and metal handles from paper or plastic containers and bags before placing them in the oven.
12. Install or locate this oven only in accordance with the installation instructions provided.
13. Eggs in the shell and whole hard-boiled eggs should not be heated in microwave ovens since they may explode, even after microwave heating has ended.
14. Use this appliance only for its intended uses as described in manual. Do not use corrosive chemicals or vapors in this appliance. This oven is especially designed to heat. It is not designed for industrial or laboratory use.
16. If the supply cord is damaged, it must be replaced by the manufacturer, its service agent or similarly qualified persons in order to avoid a hazard.
17. Do not store or use this appliance outdoors.
18. Do not use this oven near water, in a wet basement or near a swimming pool.
19. The temperature of accessible surfaces may be high when the appliance is operating. The surfaces are liable to get hot during use. Keep cord away from heated surface, and do not cover any vents on the oven.
20. Do not let cord hang over the edge of table or counter.
21. Failure to maintain the oven in a clean condition could lead to deterioration of the surface that could adversely affect the life of the appliance and possibly result in a hazardous situation.
22. The contents of feeding bottles and baby food jars shall be stirred or shaken and the temperature checked before consumption, in order to avoid burns.
23. Microwave heating of beverages can result in delayed eruptive boiling, therefore care must be taken when handling the container.
24. The appliance is not intended for use by persons (including children) with reduced physical, sensory or mental capabilities, or lack of experience and knowledge, unless they have been given supervision or instruction concerning use of the appliance by a person responsible for their safety.

25. The microwave oven should not be placed inside a cabinet.
26. The door or the outer surface may get hot when the appliance is operating.

Grounding Installation: To Reduce the Risk of Injury to Persons

DANGER

Electric Shock Hazard

Touching some of the internal components can cause serious personal injury or death. Do not disassemble this appliance.

This appliance must be grounded. In the event of an electrical short circuit, grounding reduces the risk of electric shock by providing an escape wire for the electric current. This appliance is equipped with a cord featuring a grounding wire with a grounding plug. The plug must be inserted into an outlet that is properly installed and grounded.

WARNING

Electric Shock Hazard

Improper use of the grounding can result in electric shock. Do not plug into an outlet until appliance is properly installed and grounded.

Consult a qualified electrician or serviceman if the grounding instructions are not completely understood or if doubt exists as to whether the appliance is properly grounded. If it is necessary to use an extension cord, use only a 3-wire extension cord.

CLEANING

Be sure to unplug the appliance from the power supply.

1. Clean the inside of the oven after using with a slightly damp cloth.
 2. Clean the accessories in the usual way with soapy water.
 3. The door frame and seal and neighboring parts must be cleaned carefully with a damp cloth when they are dirty.
1. A short power-supply cord is provided to reduce the risks associated with becoming entangled in or tripping over a longer cord.
 2. If a long cord set or extension cord is used:
 - 1)The marked electrical rating of the cord set or extension cord should be at least as great as the electrical rating of the appliance.
 - 2)The extension cord must be a grounding-type 3-wire cord.
 - 3)The long cord should be arranged so that it will not drape over the counter top or tabletop where it can be pulled on by children or tripped over unintentionally.

CAUTION

Personal Injury Hazard

It is hazardous for anyone other than a competent person to carry out any service or repair operation that involves the removal of a cover which gives protection against exposure to microwave energy.

UTENSILS

See the instructions on "Materials you can use in microwave oven or to be avoided in microwave oven." There may be certain non-metallic utensils that are not safe to use for microwaving. If in doubt, you can test the utensil in question following the procedure below.

Utensil Test:

1. Fill a microwave-safe container with 1 cup of cold water (250ml) along with the utensil in question.
2. Cook on maximum power for 1 minute.
3. Carefully feel the utensil. If the empty utensil is warm, do not use it for microwave cooking.
4. **Do not exceed 1 minute cooking time.**

Materials you can use in microwave oven

Utensils	Remarks
Aluminium foil	Shielding only. Small smooth pieces can be used to cover thin parts of meat or poultry to prevent overcooking. Arcing can occur if foil is too close to oven walls. The foil should be at least 2.5cm away from oven walls.
Browning dish	Follow manufacturer's instructions. The bottom of browning dish must be at least 5mm above the turntable. Incorrect usage may cause the turntable to break.
Dinnerware	Microwave-safe only. Follow manufacturer's instructions. Do not use cracked or chipped dishes.
Glass jars	Always remove lid. Use only to heat food until just warm. Most glass jars are not heat resistant and may break.
Glassware	Heat-resistant oven glassware only. Make sure there is no metallic trim. Do not use cracked or chipped dishes.
Oven cooking bags	Follow manufacturer's instructions. Do not close with metal tie. Make slits to allow steam to escape.
Paper plates and cups	Use for short-term cooking/warming only. Do not leave oven unattended while cooking.
Paper towels	Use to cover food for reheating and absorbing fat. Use with supervision for short-term cooking only.
Parchment paper	Use as a cover to prevent splattering or a wrap for steaming.
Plastic	Microwave-safe only. Follow the manufacturer's instructions. Should be labelled "Microwave Safe". Some plastic containers soften, as the food inside gets hot. "Boiling bags" and tightly closed plastic bags should be slit, pierced or vented as instructed on the package.
Plastic wrap	Microwave-safe only. Use to cover food during cooking to retain moisture. Do not allow plastic wrap to touch food.
Thermometers	Microwave-safe only (meat and candy thermometers).
Wax paper	Use as a cover to prevent splattering and retain moisture.

Materials to be avoided in microwave oven

Utensils	Remarks
Aluminium tray	May cause arcing. Transfer food into microwave-safe dish.
Food carton with metal handle	May cause arcing. Transfer food into microwave-safe dish.
Metal or metal-trimmed utensils	Metal shields the food from microwave energy. Metal trim may cause arcing.
Metal twist ties	May cause arcing and could cause a fire in the oven.
Paper bags	May cause a fire in the oven.
Plastic foam	Plastic foam may melt or contaminate the liquid inside when exposed to high temperature.
Wood	Wood will dry out when used in the microwave oven and may split or crack.

SETTING UP YOUR OVEN

Names of Oven Parts and Accessories

Remove the oven and all materials from the carton and oven cavity.

Your oven comes with the following accessories:

Glass tray	1
Turntable ring assembly	1
Instruction Manual	1

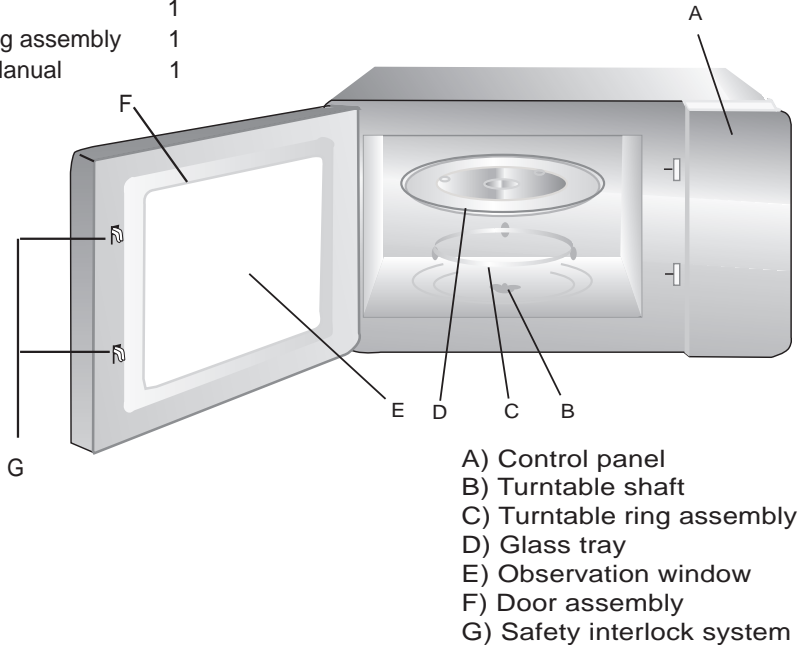

Turntable Installation

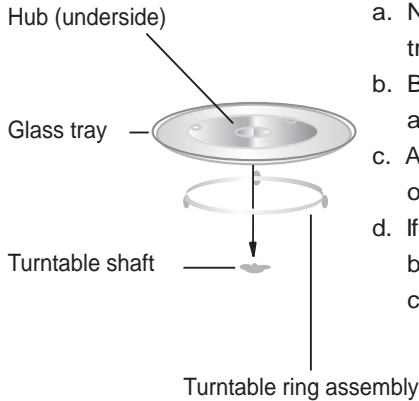

- Never place the glass tray upside down. The glass tray should never be restricted.
- Both glass tray and turntable ring assembly must always be used during cooking.
- All food and containers of food are always placed on the glass tray for cooking.
- If glass tray or turntable ring assembly cracks or breaks, contact your nearest authorized service center.

Countertop Installation

Remove all packing material and accessories. Examine the oven for any damage such as dents or broken door. Do not install if oven is damaged.

Cabinet: Remove any protective film found on the microwave oven cabinet surface.

Do not remove the light brown Mica cover that is attached to the oven cavity to protect the magnetron.

Installation

1. Select a level surface that provides enough open space for the intake and/or outlet vents.

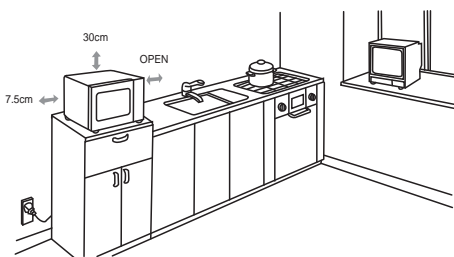

The rear surface of appliance shall be placed against a wall.

A minimum clearance of 3.0 inches (7.5cm) is required between the oven and any adjacent walls. One side must be open.

- (1) Leave a minimum clearance of 12 inches (30cm) above the oven.
- (2) Do not remove the legs from the bottom of the oven.

- (3) Blocking the intake and/or outlet openings can damage the oven.
- (4) Place the oven as far away from radios and TV as possible. Operation of microwave oven may cause interference to your radio or TV reception.
2. Plug your oven into a standard household outlet. Be sure the voltage and the frequency is the same as the voltage and the frequency on the rating label.

WARNING: Do not install oven over a range cooktop or other heat-producing appliance. If installed near or over a heat source, the oven could be damaged and the warranty would be void.

OPERATION

1. Power Level

11 power levels are available.

Level	10	9	8	7	6	5	4	3	2	1	0
Power	100%	90%	80%	70%	60%	50%	40%	30%	20%	10%	0%
Display	PL10	PL9	PL8	PL7	PL6	PL5	PL4	PL3	PL2	PL1	PL0

2. Clock Setting

(1) Press " **CLOCK** ", "00:00" will display.



(2) Press the number keys and enter the current time. For example, time is 12:10 now, please press "1,2,1,0" in turn.



(3) Press " **CLOCK** " to finish clock setting. ":" will flash and the clock will be lighted.

(4) If the numbers input are not within the range of 1:00--12:59, the setting will be invalid until valid numbers are input.

(1) In the process of clock setting, if the " **STOP/CANCEL** " button is pressed or if there is no operation within 1 minute, the oven will go back to the former setting automatically.

(2) If the clock needs to be reset, please repeat step 1 to step 3.

3. Kitchen Timer



(1) Press " **KITCHEN TIMER** ", LED will display 00:00, first hour figure will flash.

(2) Press the number keys and enter the time - the maximum cooking time is 99 minutes and 99 seconds)

(3) Press " **START/+30SEC.** " to confirm setting.



(4) When the time arrives, the buzzer will ring 5 times.

If the clock is set (12-hour system), LED will display the current time.

Note: 1) The kitchen time differs from 12-hour system, Kitchen Timer is a timer.

2) During kitchen timer, no program can be set.

4. Microwave cook

(1) Press " **TIME COOK** " once, LED will display "00:00".



(2) Press number keys to input the cooking time; the maximum cooking time is 99 minutes and 99 seconds.

(3) Press " **POWER** " once, LED will display "PL10". The default power is 100% power. Now you can press number keys to adjust the power level.

(4) Press " **START/+30SEC.** " to start cooking.

Example: to cook the food with 50% microwave power for 15 minutes.

- a. Press "**TIME COOK**" once. "00:00" displays.
- b. Press "1", "5", "0", "0" in order.
- c. Press "**POWER**" once, then press "5" to select 50% microwave power.
- d. Press "**START/+30SEC.**" to start cooking.

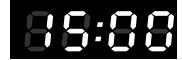

Note: 1) In the process of cooking, if the "**STOP/CANCEL**" button is pressed or if there is no operation within 1 minute, the oven will go back to the former setting automatically.

- 2) If "PL0" is selected, the oven will work with fan but no power. You can use this level to remove the odour from the oven.
- 3) During microwave cooking, "**POWER**" can be pressed to change the power you need. After pressing, the current power flashes for 3 seconds, now you can press number button to change the power. The oven will work with the selected power for the rest of the time.

5. Speedy Cooking

- (1) Instant cooking at 100% power level can be started by select a cooking time from 1 to 6 minutes by pressing number pads 1 to 6. Press "**START/+30SEC.**" to increase the cooking time; the maximum cooking time is 99 minutes and 99 seconds.
- (2) Instant cooking at 100% power level with 30 seconds' cooking time can be started by pressing "**START/+30SEC**". Each press on the same button will increase cooking time by 30 seconds. the maximum cooking time is 99 minutes and 99 seconds.

Note: during microwave cooking and time defrost, time can be added by pressing "**START/30SEC.**" button.

6. Weight Defrost Function

- (1) Press "**WEIGHT DEFROST**", LED will display "dEF1".
- (2) Press numerical buttons to input weight to be defrosted.
Input the weight ranged between 100~2000 g.
- (3) If the weight input is not within 100~2000, the input will be invalid. A "beep" will not sound and the unit will not work until valid numbers are input.
- (4) Press "**START/+30SEC.**" to start defrosting and the cooking time remaining will be displayed.

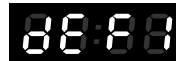

7. Time Defrost Function

- (1) Press "**TIME DEFROST**", LED will display "dEF2".
- (2) Press number pads to input defrosting time. The effective time range is 00:01~99:99
- (3) The default microwave power is power level 3. If you want to change the power level, press "**POWER**" once, and the LED will display "PL 3", then press the number pad of the power level you wanted.
- (4) Press "**START/+30SEC.**" to start defrosting. The remaining cooking time will be displayed.

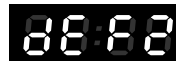

8. POPCORN

a) Press " **POPCORN** " repeatedly until the number you need appears in the display, "50", "100" grams will display in order.

For example, press "**POPCORN**" once , "50" appears.

b) Press " **START/+30 SEC.** " to cook, buzzer will sound five times and then reverts back to waiting state.

9. POTATO

a) Press " **POTATO** " repeatedly until the number you need appears in the display, "1", "2", "3" will display in order.

"1"SET: 1 potato (approximate 230 gram)

"2"SETS: 2 potatoes (approximate 460 gram)

"3"SETS: 3 potatoes (approximate 690 gram)

For example, press "**POTATO**" once , "1" appears.



b) Press " **START/+30 SEC.** " to cook, buzzer sounds once. When cooking is finished , buzzer sounds five times and then reverts back to waiting state.

10. FROZEN VEGETABLE

a) Press " **FROZEN VEGETABLE** " repeatedly until the number you need appears in the display, "150", "350", "500" grams will display in order.

For example, press "**FROZEN VEGETABLE**" once , "150" appears.

b) Press " **START/+30 SEC.** " to cook, buzzer sounds once. When cooking is finished, buzzer sounds five times and then reverts back to waiting state.

11. BEVERAGE

a) Press " **BEVERAGE** " repeatedly until the number you need appears in the display, "1", "2", "3" cup will display in order. One cup is about 120ml. For example, press "**BEVERAGE**" once , "1" appears.

b) Press " **START/+30 SEC.** " to cook, buzzer sounds once. When cooking is finished, buzzer sounds five times and then reverts back to waiting state.

12. DINNER PLATE

a) Press " **DINNER PLATE** " repeatedly until the number you wish appears in the display, "250", "350", "500" grams will display in order.

For example, press "**DINNER PLATE**" once , "250" appears.

b) Press " **START/+30 SEC.** " to cook, buzzer sounds once. When cooking finish, buzzer sounds five times and then turn back to waiting state.

13. PIZZA

- a) Press "**PIZZA**" repeatedly until the number you need appears in the display, "100", "200", "400" grams will display in order.
For example, press "**PIZZA**" once, "100" appears.
- b) Press "**START/+30 SEC.**" to cook, buzzer sounds once. When cooking is finished, buzzer sounds five times and then reverts back to waiting state.

14. MEMORY FUNCTION

- (1) Press "**0/MEMORY**" to choose memory 1-3 procedure. The LED will display 1,2,3.
- (2) If the procedure has been set, press "**START/ +30 SEC.**" to use it. If not, continue to set the procedure. Only one or two stages can be set.
- (3) After finishing the setting, press "**START/ +30 SEC.**" once to save the procedure and revert back to the waiting state. If you press "**START/ +30 SEC.**" again, it will start cooking.

Example: Use the following procedure to set the second memory, (memory 2) which cooks the food with 80% microwave power for 3 mins. and 20 secs.:

- a. In waiting state, press "**0/MEMORY**" twice, stop pressing until the screen displays "2".
- b. Press "**TIME COOK**" once, then press "3", "2", "0" in order.
- c. Press "**POWER**" once, "PL10" display, then press "8" and "PL8" displays.
- d. Press "**START/ +30 SEC.**" to save the setting. Buzzer sounds once then reverts back to waiting state. If you press "**START/+30SEC.**" again, the procedure will be saved as memory 2 and operate.
- e. If the electricity is not cut off, the procedure will be saved all the time. If it is, the procedure will need to be reset.
- f. If you want to run the saved procedure, in waiting state, press "**0/MEMORY**" twice, screen will display "2", then press "**START/+30SEC.**" to run.

15. Multi-stage cooking

At most 2 stages can be set for cooking. In multi-stage cooking, if one stage is defrosting, then defrosting shall be placed at the first stage automatically.

Note: Auto cooking cannot work in the multi-stage cooking.

Example: To cook with 80% microwave power for 5 minutes + 60% microwave power for 10 minutes, the cooking steps are as follows:

- (1) Press "**TIME COOK**" once, then press "5", "0", "0" to set the cooking time.
- (2) Press "**POWER**" once, then press "8" to select 80% microwave power.
- (3) Press "**TIME COOK**" once, then press "1", "0", "0", "0" to set the cooking time.
- (4) Press "**POWER**" once, then press "6" to select 60% microwave power.
- (5) Press "**START/ +30 SEC.**" to start cooking.

16. ENQUIRING FUNCTION

- (1) In cooking state, press " **CLOCK** ", the LED will display clock for three seconds.
- (2) In the microwave cooking state, press " **POWER** " to check microwave power level, and the current microwave power will be displayed. After three seconds, the oven will revert back to the previous state. In multi-stage state, the enquiring can be done using the same method as above.

17. LOCK FUNCTION FOR CHILDREN

Lock: In waiting state, press " **STOP/CANCEL** " for 3 seconds, there will be a long "beep" denoting the entering into the child-lock state; meanwhile, LED will display "  "

Lock quitting: In locked state, press " **STOP/CANCEL** " for 3 seconds, there will be a long "beep" denoting that lock has been released.

18. COOKING END REMINDER FUNCTION

When the cooking is over, the buzzer will sound 5 "beeps" to alert user the cooking is finished.

19. OTHER SPECIFICATIONS

- (1) In standby state , if the set clock digital tube displays current time, the icon will flash; otherwise, it shows " **0:00** " .
- (2) In setting function state, LED displays corresponding setting.
- (3) In working or pause state, LED displays surplus cooking time.

Trouble shooting

Normal	
Microwave oven interfering TV reception	Radio and TV reception may be interfered when microwave oven operating. It is similar to the interference of small electrical appliances, like mixer, vacuum cleaner, and electric fan. It is normal.
Dim oven light	In low power microwave cooking, oven light may become dim. It is normal.
Steam accumulating on door, hot air out of vents	In cooking, steam may come out of food. Most will get out from vents. But some may accumulate on cool place like oven door. It is normal.
Oven started accidentally with no food in.	It is forbidden to run the unit without any food inside. It is very dangerous.

Trouble	Possible Cause	Remedy
Oven can not be started.	(1) Power cord not plugged in tightly.	Unplug. Then plug again after 10 seconds.
	(2) Fuse blowing or circuit breaker works.	Replace fuse or reset circuit breaker (repaired by professional personnel of our company)
	(3) Trouble with outlet.	Test outlet with other electrical appliances.
Oven does not heat.	(4) Door not closed well.	Close door well.
Glass turntable makes noise when microwave oven operates	(5) Dirty roller rest and oven bottom.	Refer to "Maintenance of Microwave" to clean dirty parts.



If at any time in the future you need to dispose of this product please do NOT dispose of this product with general household waste. This electrical appliance is to be recycled only.



Backed by the Nero 1 Year Warranty

**Imported By
R. Weatherdon & Co Pty Ltd
Sydney - Australia**

www.weatherdon.com.au

Made in China