

AWM4
Australian Imperial Force unit war diaries,
1914-18 War

Formation Headquarters

Item number: 1/50/29 Part 4

Title: General Staff, Headquarters 5th
Australian Division

July 1918



AWM4-1/50/29PART4

draft

28. 53/

SECRET.

5th AUSTRALIAN DIVISION LOCATION REPORT.-1/7/18.

1st Amendment.

54th Battalion	J.22.d.2.5	Line Right.
55th "	J.21.c.5.7	Reserve.
56th "	J.22.d.2.4	Line centre.
59th "	J.5.d.8.9	Right Support.

5th July, 1918.

Jim A. Chapman, Capt.
 Lieut-Colonel, G.S.
 5th AUSTRALIAN DIVISION.

SECRET.

5th AUSTRALIAN DIVISION LOCATION REPORT.

Anticipated as at 6 a.m. 2nd July, 1918.

NOT TO BE PUT UP IN ANY PLACE OPEN TO THE PUBLIC.

Ref. Sheet 62D N.E. and S.E. 1/20,000.

DIVISIONAL HEADQUARTERS.	B.27.b.0.1	St. GRATIEN Chateau.
5th AUST. DIV. ARTILLERY H.Q.		RENANCOURT.
13th A.F.A. Bde.	I.13.d.05.57	
14th A.F.A. Bde.	I.24.d.06.59	Petit St. JEAN.
5th D.A.C.		
S.A.A. Section, 5th Aust. D.A.C.	I.7.a.central.	
2nd AUST. DIV. ARTILLERY H.Q.		St. GRATIEN Maire.
6th Army Bde. A.F.A.	J.1.c.80.65)	Left group.
4th A.F.A. Brigade.	D.13.d.55.75)	
3rd Army Bde. A.F.A.	J.1.a.3.9)	Right Group.
5th A.F.A. Bde.	J.1.c.5.1)	
5th Bde. R.H.A.	H.23.b.5.9	Mobile Reserve Bde.
2nd Aust. D.A.C.	H.6.b.7.6.	
2nd Aust. D.T.M.O.	J.1.c.5.4	HEILLY.
5th AUST. DIV. ENGINEERS H.Q.		St. GRATIEN.
8th Field Company.	I.6.c.1.7	
14th " " "	I.5.a.2.2	
15th " " "	D.26.b.1.9	
8th AUST. INF. BDE. H.Q.		FRECHENCOURT Chateau.
29th Battalion.	I.10.c.6.8	
30th " "	C.29.d.3.7	
31st " "	I.4.a.35.25	
32nd " "	I.18.d.70.45	
8th L.T.M. Battery.	I.9.a.1.1	
8th Bde. School	G.24.b.80.60	
14th AUST. INF. BDE. H.Q.	J.1.c.45.05	(Right).
53rd Battalion.	J.17.b.3.8	Line Left.
54th " "	J.21.c.5.7	Reserve.
55th " "	J.22.d.2.4	Line Right.
56th " "	J.22.d.2.4	Support.
14th L.T.M. Battery.	J.22.d.2.4	
14th Brigade School	H.3.c.2.2	
15th AUST. INF. BDE. H.Q.	J.1.c.80.15	HEILLY Chateau (Left).
57th Battalion.	D.29.b.2.5	Left line.
58th " "	D.27.a.2.4	Left Support.
59th " "	J.9.b.8.1	Right Support
60th " "	J.11.a.6.8	Line right.
15th L.T.M. Battery.	D.29.d.4.2	
15th Inf. Bde. School.	H.1.d.9.5	
5th AUST. M.G. BATTALION H.Q.	C.21.c.45.25	
8th M.G. Co.	C.26.b.45.45	
14th " "	J.5.b.25.30	
15th " "	D.27.a.3.5	Line Left.
25th " "	J.10.c.80.20	
		P.T.O.

A.D.M.S.
 8th Field Ambulance D.C.S.
 14th " " A.D.S.
 15th " " M.D.S.
 5th Sanitary Section

G.30.a.8.2
 I.4.b.8.0
 H.10.a.9.4
 G.33.d.8.4

St. GRATIEN.
 PETIT CAMON.

DENTAL UNITS.
 No. 2 attach. 8th Fld. Amb.
 No. 32 " 14th " "
 No. 23 " 15th " "
 No. 101 " 5th Aust. D.A.C.

I.4.b.8.0
 H.10.a.9.4

PETIT CAMON.

5th AUST. DIV. TRAIN H.Q.
 10th Co. A.A.S.G.
 18th Co. "
 28th Co. "
 29th Co. "
 S.S.O.

H.26.a.9.8

ALLONVILLE Chateau

H.20.c.3.3
 H.20.c.8.0
 H.26.b.5.5
 H.26.a.9.7

DIVISIONAL TROOPS.
 D.A.D.V.S.
 5th Pioneer Battalion.
 5th Aust. Mob. Vet. Section.
 A.P.M.
 D.A.D.O.S.
 Div. Paymaster.
 5th Mechanical Transport Co.
 5th Aust. Salvage Co.
 Burials Officer.
 Gas Officer.
 Claims Officer.

J.1.c.9.7
 B.26.b.9.9

St. GRATIEN.

G.20.central

St. GRATIEN.

G.3.d.8.2
 H.16.b.5.3

St. GRATIEN.

St. GRATIEN.

"

ATTACHED TROOPS.
 No. 1 Troop, "B" Sqdn 13th ALH.
 Cyclists Platoon.
 "Z" Spec. Co. R.E.

I.15.b.4.7
 I.15.b.4.7
 M.16.a.4.3

CAMON.

MISCELLANEOUS.
 French Mission.
 5th A.D.R.W.
 Div. Canteen.
 Railhead.
 Ammunition Railhead.
 1st Sanitary Section.
 Comforts fund.
 Y.M.C.A.
 Staging Camp.
 Nucleus
 Divisional O.P.
 "A" Coy. 13th Tank Bn.

B.27.c.4.8

St. GRATIEN.
 PERNOIS.
 FRECHENCOURT (opp. Church)
 POULAINVILLE.
 FLESSELLES.
 St. GRATEEN.
 "

B.20.d.5.1

FRECHENCOURT.

D.22.c.45.45
 J.1.d

PERNOIS.

HEILLY.

C.29.c.0.0

FRANVILLERS.
 POULAINVILLE.

P.O.W. CAGES.
 Divisional Cage.
 Corps Cage.

Jim A. Chapman, Capt.
 Lieut-Colonel, G.S.
 5th AUSTRALIAN DIVISION.

1st July, 1918.

NOTE: All alterations and amendments should be notified to Divisional Headquarters as soon as possible.

233

5 *beard*

SECRET.

Ig.53/551

5th AUSTRALIAN DIVISION LOCATION REPORT 8/7/18.

1st Amendment.

53rd Battalion.
55th "

J.21.c.5.7
J.17.b.3.8

8th M.G. Company.
15th M.G. Company.

D.27.a.3.5
C.21.c.50.25

11th July, 1918.

John Chapman
Lieut-Colonel, G.S.
5th AUSTRALIAN DIVISION.

APPENDIX. 3

1344

SECRET

Fig. 33/185

5th AUSTRALIAN DIVISION LOCATION REPORT.

Anticipated as at 6 a.m. 9th July, 1918.

NOT TO BE PUT UP IN ANY PLACE OPEN TO THE PUBLIC.

Ref. Sheet 62.D N.E. and S.E. 1/20,000.

DIVISIONAL HEADQUARTERS.	B.27.b.0.1	St. GRATIEN Chateau.
5th AUST DIV. ARTILLERY H.Q.		REMANCOURT.
13th A.F.A. Bde.	I.29.c.90.10	
14th A.F.A. Bde.	I.24.b.60.00	
5th D.A.C.		PETIT St. JEAN.
S.A.A. Section, 5th Aust. D.A.C.	I.7.a.central.	
2nd AUST DIV. ARTILLERY H.Q.		St. GRATIEN Maire.
6th Army Bde. A.F.A.	J.1.c.80.65) Left Group.
4th A.F.A. Brigade.	D.13.d.55.75	
3rd Army Bde. A.F.A.	J.8.b.15.55) Right Group.
5th A.F.A. Bde.	J.1.c.5.1	
5th Bde. R.H.A.	H.23.b.5.9	Mobile Reserve Bde.
2nd Aust. D.A.C.	H.6.b.7.6.	
2nd Aust. D.T.M.O.	J.1.c.5.4	HEILLY.
5th AUST. DIV. ENGINEERS H.Q.		St. GRATIEN.
8th Field Company.	I.6.c.1.7	
14th " "	I.5.a.2.2	
15th " "	D.26.b.1.9	
8th AUST. INF. BDE. H.Q.		FRECHENCOURT Chateau.
29th Battalion.	I.10.c.6.8	
30th " "	C.29.d.3.7	
31st " "	I.4.a.35.25	
32nd " "	I.18.d.70.45	
8th L.T.M. Battery.	I.9.a.1.1	
8th Bde. School.	G.24.b.80.60	
14th AUST. INF. BDE. H.Q.	J.1.c.45.05	(Right)
53rd Battalion.	J.17.b.3.8	(Line left).
54th Battalion.	J.22.d.2.5	(Line left).
55th " "	J.21.c.5.7	(Support).
56th " "	J.22.d.2.4	(Line centre).
14th L.T.M. Battery.	J.22.d.2.4.	
14th Brigade School.	H.3.c.2.2	
15th AUST. INF. BDE. H.Q.	J.1.c.80.15	HEILLY Chateau (left).
57th Battalion.	D.29.b.2.3	(Line left).
58th " "	J.11.a.6.8	(Line right).
59th " "	J.9.b.8.1	(Support Right).
60th " "	D.27.a.2.4	(Support left).
15th L.T.M. Battery.	D.29.d.4.2	
15th Inf. Bde. School.	H.1.d.9.5	
5th AUST. M.G. BATTALION H.Q.	C.21.c.45.25	
8th M.G. Company.	C.26.b.45.45	
14th " "	J.5.b.25.30	
15th " "	D.27.a.3.5	(line left).
25th " "	J.10.c.80.20	

P.T.O.

A.D.M.S.

8th Field Ambulance D.C.S.
14th " " A.D.S.
15th " " M.D.S.
5th Sanitary Section.

G.30.a.8.2
I.4.b.8.0
H.10.a.9.4
G.33.d.8.4

St. GRATIEN.
PETIT CAMON.
(TYPE TOLF)

DENTAL UNITS.

No. 2 attach. 8th Fld.Amb.
No. 32 " 14th " "
No. 23 " 15th " "
No. 101 " 5th Aust. D.A.C.

I.4.b.8.0
H.10.a.9.4

PETIT CAMON.

5th AUST. DIV. TRAIN H.Q.

10th Co. A.A. S.C.
18th Co. "
28th Co. "
29th Co. "
S.S.O.

H.26.a.9.8
H.20.c.3.3
H.20.c.8.0
H.26.b.5.5
H.26.a.9.7

ALLONVILLE Chateau.

DIVISIONAL TROOPS.

D.A.D.V.S.
5th Pioneer Battalion.
5th Aust. Mob. Vet. Section.
A.P.M.
D.A.D.O.S.
Div. Paymaster.
5th Mechanical Transport Co.
5th Aust. Salvage Co.
Burials officer.
Gas Officer.
Claims officer.

J.1.c.9.7
B.26.b.9.9
G.20.central.
G.3.d.8.2
H.16.b.5.3

St. GRATIEN.

St. GRATIEN.

St. GRATIEN.

St. GRATIEN.

ATTACHED TROOPS.

No. 1 Troop, "B" Sqdn 13th ALH.
Cyclists platoon.
"2" Spec. Co. R.E.

I.15.b.4.7
I.15.b.4.7
M.16.a.4.3

CAMON.

MISCELLANEOUS.

French Mission.
5th A.D.R.W.
Div. Canteen.
Railhead.
Ammunition Railhead.
1st Sanitary Section.
Comforts fund.
Y.M.C.A.
Staging Camp
Nucleus.
Divisional O.P.
"A" Coy. 13th Tank Bn.

B.27.c.4.8
B.20.d.5.1
D.22.c.45.45
J.1.d

St. GRATIEN.
PERNOIS.
FRECHENCOURT (opp Church).
POULAINVILLE.
FLESSELLES.
St. GRATIEN.
"
FRECHENCOURT.
PERNOIS.
HEILLY.

P.O.W. CAGES.

Divisional Cage.
Corps Cage.

C.29.c.0.0

FRANVILLERS.
POULAINVILLE.

8th July, 1918.

R. Murray Kent
Lieut-Colonel, GS.
5th AUSTRALIAN DIVISION

NOTE: All alterations and amendments should be notified to Divisional Headquarters as soon as possible.

Blank

SECRET.

Ig.33/998

5th AUSTRALIAN DIVISION LOCATION REPORT.

1st Amendment.

Delete all artillery units shown in Location Report of 13th July, 1918 and substitute.-

5th AUST. DIV. ARTILLERY H.Q.
 13th A.F.A. Bde.
 6th A.F.A. Bde.
 14th A.F.A. Bde.
 5th D.A.C.
 10th A.F.A. Bde.
 11th A.F.A. Bde.
 5th Bde. R.H.A.
 5th Aust. D.T.M.O.
 4th D.A.C.

J.1.a.10.90	St. GRATIEN.
J.1.c.80.65)	Superimposed.
D.13.d.55.75)	Left Group.
H.6.b.70.60.	
J.1.a.50.10)	Right Group.
J.8.b.15.55)	
H.23.b.50.90	Mobile reserve.
J.1.c.50.40	
H.6.b.70.60.	

John G. ...
 Lieut-Colonel, G.S.
 5th AUSTRALIAN DIVISION.

15th July, 1918.

APPENDIX.

3

137

233

Dray

Ig.33/792

SECRET .

Corrigendum 5th AUSTRALIAN DIVISION LOCATION REPORT, issued 13th
July, 1918; for 56th Battalion " H.22.d.2.4" ,
read 56th Battalion " J.22.d.2.4" .

J. A. Chapman
Lieut-Colonel, G.S.
5th AUSTRALIAN DIVISION.

13th July, 1918

APPENDIX. 3

138

SECRET.

Ig.33/754

5th AUSTRALIAN DIVISION LOCATION REPORT.

Anticipated as at 6 a.m. 14th July, 1918.

NOT TO BE PUT UP IN ANY PLACE OPEN TO THE PUBLIC.

Re. Sheet 62.D. N.E. and S.E. 1/20,000.

DIVISIONAL HEADQUARTERS.	B.27.b.0.1	St. GRATIEN Chateau.
5th AUST. DIV. ARTILLERY H.Q.		RENANCOURT.
13th A.F.A. Bde.	I.29.c.90.10	
14th A.F.A. Bde.	I.24.b.60.00	PETIT St. JEAN.
5th D.A.C.		
S.A.A. Section, 5th Aust.D.A.C.	I.7.a.central.	
2nd Aust. Div. Artillery H.Q.		St. GRATIEN Maire.
6th Army Bde. A.F.A.	J.1.c.80.65)	Left Group.
4th A.F.A. Brigade.	D.13.d.55.75)	
3rd Army Bde. A.F.A.	J.8.b.15.55)	Right Group.
5th A.F.A. Bde.	J.1.c.5.1)	
5th Bde. R.H.A.	H.23.b.5.9	Mobile Reserve Bde.
2nd Aust. D.A.C.	H.6.b.7.6	
2nd Aust. D.T.M.Ⓞ	J.1.c.5.4	HEILLY.
5th AUST. DIV. ENGINEERS H.Q.		St. GRATIEN.
8th Field Company.	I.5.a.2.2	
14th " "	I.6.c.1.7	
15th " "	D.26.b.1.9	
8th AUST. INF. BDE. H.Q.		FRECHENCOURT Chateau.
29th Battalion.	I.10.c.6.8	
30th " "	C.29.d.3.7	
31st " "	I.4.a.35.25	
32nd " "	I.18.d.70.45	
8th L.T.M. Battery.	I.9.a.1.1	
8th Bde. School.	G.24.b.80.60	
14th AUST. INF. BDE. H.Q.	J.1.c.45.05	(Right).
53rd Battalion.	J.22.d.10.40	(Support).
54th " "	J.22.c.9.8	(Line right).
55th " "	J.17.b.3.8.	(Line left).
56th " "	H.22.d.2.4	(Line centre).
14th L.T.M. Battery.	J.17.b.4.8	
14th Brigade School.	H.3.c.2.2	
15th AUST. INF. BDE. H.Q.	J.1.c.45.05	HEILLY Chateau (left).
57th Battalion.	D.29.b.2.3	(Line left).
58th " "	D.27.a.2.4	(Support Left).
59th " "	J.9.b.8.1	(Support right).
60th " "	J.11.a.6.8	(Line right).
15th L.T.M. Battery.	D.29.d.4.2	
15th Inf. Bde. School.	H.1.d.9.5	
5th AUST. H.G. BATTALION. H.Q.	C.21.c.45.25	
8th M.G. Company.	D.27.a.3.5	
14th " "	J.5.b.25.30	
15th " "	C.21.c.50.25	
25th " "	J.10.c.80.20	

P. T. Ⓞ

NOTE: All alterations and amendments should be notified to Divisional Headquarters as soon as possible.

13th July, 1918.

R. M. ...
 Lt. Colonel, G.S.
 5th Australian Division.

P.O.M. GAGES.	Divisional Gage.	G.29.c.0.0	FRANVILLE.	FRANVILLE.

"A" Coy. 13th Tank Bn.	Divisional O.P.	D.22.c.45.45	HEILY.	PERNOIS.
Nucleus.	Staging Camp.	B.20.d.5.1	FRICHENCOURT.	FRICHENCOURT.
Y.M.C.A.	Comforts Fund.	B.27.c.4.8	St. GRATIEN.	St. GRATIEN.
1st Sanitary Section.	Ammunition railhead.	I.15.b.4.7	FRICHENCOURT (opp. Church).	FRICHENCOURT.
Railhead.	Div. Canteen.	M.16.a.4.3	PERNOIS.	PERNOIS.
5th A.D.R.W.	French Mission.	I.15.b.4.7	St. GRATIEN.	St. GRATIEN.
MISCELLANEOUS.				
"Z" Spec. Co. R.E.	Cyclists platoon.	I.15.b.4.7	GAMON.	GAMON.
ATTACHED TROOPS.				
No. 1 troop, "B" Sqn. 13thALB.	Claims Officer.	I.16.b.5.3	St. GRATIEN.	St. GRATIEN.
	Gas Officer.	G.3.d.8.2	St. GRATIEN.	St. GRATIEN.
	Burials Officer.	G.20.central.	St. GRATIEN.	St. GRATIEN.
	5th Aust. Salvage Co.	B.26.b.9.9	St. GRATIEN.	St. GRATIEN.
	5th Mechanical Transport Co.	J.1.c.9.7	St. GRATIEN.	St. GRATIEN.
	Div. Paymaster.	H.26.a.9.8	St. GRATIEN.	St. GRATIEN.
	D.A.D.O.S.	H.26.a.9.7	St. GRATIEN.	St. GRATIEN.
	A.P.M.	H.20.c.3.3	St. GRATIEN.	St. GRATIEN.
	5th Aust. Mob. Vet. Section.	H.20.c.8.3	St. GRATIEN.	St. GRATIEN.
	5th Pioneer Battalion.	H.20.c.8.3	St. GRATIEN.	St. GRATIEN.
	D.A.D.V.S.	H.26.a.9.8	St. GRATIEN.	St. GRATIEN.
DIVISIONAL TROOPS.				
	SSO	H.26.a.9.8	St. GRATIEN.	St. GRATIEN.
	29th Coy.	H.20.c.8.3	St. GRATIEN.	St. GRATIEN.
	" "	H.20.c.8.3	St. GRATIEN.	St. GRATIEN.
	18th Coy.	H.26.a.9.8	St. GRATIEN.	St. GRATIEN.
	" "	H.20.c.8.3	St. GRATIEN.	St. GRATIEN.
	10th Coy. A.A.S.G.	H.10.e.9.4	St. GRATIEN.	St. GRATIEN.
	5th Aust. Div. Train. H.Q.	I.4.b.8.0	St. GRATIEN.	St. GRATIEN.
	No. 101	H.26.a.9.8	St. GRATIEN.	St. GRATIEN.
	" "	I.4.b.8.0	St. GRATIEN.	St. GRATIEN.
	No. 23	G.35.d.8.4	St. GRATIEN.	St. GRATIEN.
	" "	H.10.a.9.4	St. GRATIEN.	St. GRATIEN.
	No. 32	I.4.b.8.0	St. GRATIEN.	St. GRATIEN.
	No. 2 attach. 8th Fla. Amb.	G.30.a.8.2	St. GRATIEN.	St. GRATIEN.
DENTAL UNITS.				
	5th Sanitary section.	I.4.b.8.0	St. GRATIEN.	St. GRATIEN.
	15th	H.10.a.9.4	St. GRATIEN.	St. GRATIEN.
	" "	I.4.b.8.0	St. GRATIEN.	St. GRATIEN.
	8th Field Ambulance	G.30.a.8.2	St. GRATIEN.	St. GRATIEN.
	D.C.S.	H.10.e.9.4	St. GRATIEN.	St. GRATIEN.
	A.D.S.	G.35.d.8.4	St. GRATIEN.	St. GRATIEN.
	M.D.S.	H.26.a.9.8	St. GRATIEN.	St. GRATIEN.

ATLONVILLE Chateau.

PETIT CAMON.

PETIT CAMON.

W. d.

Ig.33/2230.

5th AUSTRALIAN DIVISION LOCATION REPORT. 17/7/18.

3rd Amendment.

30th Battalion	D.27.a.2.4	Support.
32nd "	J.17.b.3.8	Line right.
55th "	J.22.d.2.4	Line left.
56th "	J.22.d.10.40	Support.

For "A" Company 13th Tank Battalion.
read "C" " 13th " "

24th July, 1918.

Jim. G. Chapman Capt
for Lieut-Colonel, G.S.
5th AUSTRALIAN DIVISION.

283

Ig.33/

5th AUSTRALIAN DIVISION LOCATION REPORT -17/7/18.

2nd Amendment.

10th Aust. F.A. Bde.
5th Army Bde. R.H.A.
14th Aust. F.A. Bde.

J.1.c.50.10
D.21.c.90.30
C.21.c.1.8.

21st July, 1918..

Jim A. Chapman Capt
for Lieut-Colonel, G.S.
5th AUSTRALIAN DIVISION.

APPENDIX. 3.142

W. d

SECRET. Ig.33/
5th AUSTRALIAN DIVISION LOCATION REPORT. 17/7/18.
1st Amendment.

25th Machine Gun Co.	C.21.c.40.00.	
55th Battalion.	J.22.d.2.4	Line left.
56th "	J.22.d.10.40	Support.

19th July, 1918.

Jim. A. Chapman, Capt.
Lieut-Colonel, G.S.
5th AUSTRALIAN DIVISION.

Scarf

SECRET

Ig.33/1685

5th AUSTRALIAN DIVISION LOCATION REPORT.

Anticipated as at 6 a.m. 18th July, 1918.

NOT TO BE PUT UP IN ANY PLACE OPEN TO THE PUBLIC.

Ref. Sheet 62.D N.E. and S.E. 1/20,000.

DIVISIONAL HEADQUARTERS.	B.27.b.0.1	St. GRATIEN Chateau.
5th AUST. DIV. ARTILLERY H.Q.		St. GRATIEN.
13th A.F.A. Bde.	J.1.a.10.90	Superimposed.
6th A.F.A. Bde.	J.1.c.80.65)	Left Group.
14th A.F.A. Bde.	D.13.d.55.75)	
5th D.A.C.	H.6.b.70.60.	
10th A.F.A. Bde.	J.1.a.50.10)	Right Group.
11th A.F.A. Bde.	J.8.b.15.55)	
5th/R.H.A.	H.23.b.50.90	Mobile reserve.
5th Aust. D.T.M.O.	J.1.c.50.40	
4th D.A.C.	H.6.b.70.60	
5th AUST. DIV. ENGINEERS H.Q.		St. GRATIEN.
8th Field Company.	I.5.a.2.2	
14th " "	I.6.g.1.7	
15th " "	D.26.b.1.9	
8th AUST. INF. BDE. H.Q.	J.1.c.45.05	Left.
29th Battalion.	J.11.a.6.8	Line centre.
30th " "	J.17.b.3.8	Line Right.
31st " "	D.29.b.2.3	Line left.
32nd " "	D.27.a.2.4	Support.
8th L.T.M. Battery.	D.29.d.4.2	
8th Brigade School	G.24.b.80.60	
14th AUST. INF. BDE. H.Q.	J.1.c.45.05	Right.
53rd Battalion.	J.22.c.9.8	Line right.
54th " "	J.21.c.5.7	Reserve.
55th " "	J.22.d.10.40	Support.
56th " "	J.22.d.2.4	Line left.
14th L.T.M. Battery.	J.17.b.4.8	
14th Brigade. School.	H.3.c.2.2	
15th AUST. INF. BDE. H.Q.		FRECHENCOURT (Reserve).
57th Battalion.	G.29.d.3.7	
58th " "	I.4.a.35.25	
59th " "	I.18.d.70.45	
60th " "	I.10.c.60.80	
15th L.T.M. Battery.	I.9.a.1.1	
15th Inf. Bde. School.	H.1.d.9.5.	
5th AUST. M.G. BATTALION H.Q.	C.21.c.45.25	
8th M.G. Company.	D.27.a.3.5	
14th " "	J.5.b.25.30	
15th " "	J.10.c.80.20	
25th " "	C.21.c.50.25	
A.D.M.S.		St. GRATIEN.
8th Field Ambulance D.C.S.	G.30.a.8.2	
14th " " A.D.S.	I.4.b.8.0	
15th " " M.D.S.	H.10.a.9.4	
5th Sanitary Section.	G.33.d.8.4	

DENTAL /

NOTE: All alterations and amendments should be notified to Divisional Headquarters as soon as possible.

5th AUSTRALIAN DIVISION.
Lieut-colonel. G.S.

John G. Johnson Capt

17th July, 1918.

FRANVILLERS.	G.29.c.0.0	FRANVILLERS.	F.O.W. GAGES.
FOUVAINVILLE.		FOUVAINVILLE.	Divisional Gage.
HEILLY.	J.1.d.	HEILLY.	Corps Gage.
PERMOIS.	D.22.c.45.45	PERMOIS.	"A" Coy. 13th Bank Bn.
FRUCHENGOURT.	B.20.d.5.1	FRUCHENGOURT.	Divisional O.P.
St. GRATIEN.	B.27.c.4.8	St. GRATIEN.	Nucleus.
PERMOIS.		PERMOIS.	Staging Camp.
FRUCHENGOURT (opp. Church).		FRUCHENGOURT (opp. Church).	Y.M.C.A.
St. GRATIEN.		St. GRATIEN.	Comforts Fund.
PERMOIS.		PERMOIS.	1st Sanitary Section.
CAMON.	M.16.a.4.3	CAMON.	Ammunition railhead.
St. GRATIEN.	I.15.b.4.7	St. GRATIEN.	Railhead.
St. GRATIEN.	I.15.b.4.7	St. GRATIEN.	Div. Ganteen.
St. GRATIEN.		St. GRATIEN.	5th A.D.R.W.
St. GRATIEN.		St. GRATIEN.	French Mission
St. GRATIEN.		St. GRATIEN.	MISCELLANEOUS.
St. GRATIEN.		St. GRATIEN.	No. 1 Troop, "B" Sqn, 13 ALH.
St. GRATIEN.		St. GRATIEN.	Cyclists Platoon.
St. GRATIEN.		St. GRATIEN.	"Z" Spec. Co. R.E.
St. GRATIEN.		St. GRATIEN.	ATTACHED TROOPS.
St. GRATIEN.		St. GRATIEN.	Claims Officer.
St. GRATIEN.		St. GRATIEN.	Gas Officer.
St. GRATIEN.		St. GRATIEN.	Burials Officer.
St. GRATIEN.		St. GRATIEN.	5th Aust. Salvage Co.
St. GRATIEN.		St. GRATIEN.	5th Mechanical Transport Co.
St. GRATIEN.		St. GRATIEN.	Div. Paymaster.
St. GRATIEN.		St. GRATIEN.	D.A.D.O.S.
St. GRATIEN.		St. GRATIEN.	A.P.M.
St. GRATIEN.		St. GRATIEN.	5th Aust. Mob. Vet. Section.
St. GRATIEN.		St. GRATIEN.	5th Pioneer Battalion.
St. GRATIEN.		St. GRATIEN.	D.A.D.V.S.
St. GRATIEN.		St. GRATIEN.	DIVISIONAL TROOPS.
St. GRATIEN.		St. GRATIEN.	S.S.O.
St. GRATIEN.		St. GRATIEN.	29th
St. GRATIEN.		St. GRATIEN.	28th
St. GRATIEN.		St. GRATIEN.	18th
St. GRATIEN.		St. GRATIEN.	10th Coy. A.A.S.C.
St. GRATIEN.		St. GRATIEN.	5th AUST. DIV. TRAIN H.Q.
St. GRATIEN.		St. GRATIEN.	No. 101
St. GRATIEN.		St. GRATIEN.	No. 23
St. GRATIEN.		St. GRATIEN.	No. 32
St. GRATIEN.		St. GRATIEN.	No. 2 attach. 8th Fld. Amb.
St. GRATIEN.		St. GRATIEN.	DENTAL UNITS.

Dray

Ig33/4100

SECRET.

5th AUSTRALIAN DIVISION LOCATION REPORT.

Anticipated as at 10 a.m. 28th July 1918.

NOT TO BE PUT UP IN ANY PLACE OPEN TO THE PUBLIC.

Ref. Sheet 62 D N.E. and S.E. 1/20,000

DIVISIONAL HEADQUARTERS	B.27.b.0.1	ST.GRATIEN Chateau
5th AUST. DIV. ARTILLERY H.Q.		ST.GRATIEN
13th A.F.A. Bde.	J.1.a.10.90	Superimposed
11th A.F.A. Bde.	J.1.c.80.85	Left Group
10th A.F.A. Bde.	J.1.c.50.10)	Right Group
23rd F.A. Bde.	I.23.d.5.7)	
14th A.F.A. Bde.	C.21.c.1.8	Mobile Reserve
5th D.A.C.	H.6.b.70.60	
4th D.A.C.	H.6.b.70.60	
5th Aust. D.T.M.O.	J.1.c.95.50	
5th AUST. DIV. ENGINEERS H.Q.		ST.GRATIEN
8th Field Company	I.5.a.2.2.	
14th " "	I.6.c.1.7.	
15th " "	D.26.b.1.9.	
8th AUST. INF. BRIGADE H.Q.	J.1.c.45.05	Left
29th Battalion	J.11.a.6.8.	Line left
30th " "	I.18.d.70.45	Reserve
31st " "	J.9.b.8.1.	Support
32nd " "	J.17.b.2.8.	Line Right
8th L.T.M. Battery	J.5.d.70.45	
8th Brigade School	C.24.b.80.60	
14th AUST. INF. BRIGADE H.Q.	J.1.c.45.05	Right
53rd Battalion	J.22.d.2.4	Line left
54th " "	J.22.c.9.8	Line right
55th " "	J.21.c.5.7	Reserve
56th " "	J.22.d.10.40	Support
14th L.T.M. Battery	J.17.b.4.8	
14th Brigade School	H.3.c.2.2.	
15th AUST. INF. BRIGADE H.Q.		FRESHENCOURT (reserve)
57th Battalion	B.27.b.1.3	ST.GRATIEN
58th " "	I.4.a.35.25	
59th " "	C.29.d.3.7.	
60th " "	I.10.c.60.80	
15th L.T.M. Battery	I.9.a.1.1	
15th Brigade School	H.1.d.9.5.	
5th AUST. M.G. BATTALION H.Q.	C.21.c.45.25	
8th M.G. Company	C.26.b.40.40	
14th " "	J.5.b.25.30	
15th " "	J.10.c.80.20	
25th " "	C.21.c.40.00	
A.D.M.S.		ST.GRATIEN
8th Field Ambulance D.C.S.	G.30.8.2.	
14th " " A.D.S.	I.4.b.8.0.	
15th " " M.D.S.	H.10.a.9.4.	
5th Sanitary Section	G.35.d.9.4.	

DENTAL UNITS

No. 2 attach.	8th Fld. Amb.	
No. 32 "	14th " "	I.4.b.8.0.
No. 23 "	15th " "	H.10.a.9.4.
No. 101 "	5th Aust. D.A.C	

PETIT CAMON

5th AUST. DIV. TRAIN H.Q.
 10th Coy. A.A.S.C.
 18th " "
 28th " "
 29th " "
 C.S.O.

H.26.a.9.8.
 H.20.c.3.3.
 H.20.c.8.3
 H.26.b.5.5.
 H.26.a.9.7.

ALLONVILLE Chateau

DIVISIONAL TROOPS

D.A.D.V.S.
 5th Pioneer Battalion
 5th Mob. Vet. Section
 A.P.M.
 D.A.D.O.S.
 Div. Paymaster
 5th Mech. Transport Co.
 5th Aust. Salvage Co.
 Burials Officer
 Gas Officer
 Claims Officer

J.1.c.9.7.
 B.26.b.9.9.
 G.20.central
 G.3.d.8.2
 H.16.b.5.3

ST.GRATIEN
 ST.GRATIEN
 ST.GRATIEN
 ST.GRATIEN
 ST.GRATIEN
 ST.GRATIEN

ATTACHED TROOPS

No.1 Troop "B" Sq. 13th A.L.H.I.15.b.4.7
 Cyclists Platoon I.15.b.4.7.
 "2" Spec. Co. R.E. M.16.a.4.3.

CAMON

MISCELLANEOUS

French Mission
 5th A.D.R.V.
 Div. Canteen
 Railhead
 Ammunition railhead
 1st Sanitary Section
 Comforts Fund
 Y.M.C.A.
 Staging Camp
 Nucleus
 Divisional O.P.
 "C" Coy 15th Tank Bn.
 P.O.W. CAGES
 Divisional Cage
 Corps Cage

B.27.c.4.8.
 B.20.d.5.1
 D.22.c.45.45
 J.1.d.
 C.29.c.0.0.

ST. GRATIEN
 PERNOIS
 FRECHENCOURT (opp Church)
 POULAINVILLE
 FLESBELLES
 ST. GRATIEN
 ST. GRATIEN
 F. ECHENCOURT
 PERNOIS
 HEILLY
 FRANVILLERS
 POULAINVILLE

Jim A. Chapman Capt.
 Maj. Lieut-Colonel, G.S.,
 5th AUSTRALIAN DIVISION.

28th July 1918.

NOTE: All alterations and amendments should be notified to Divisional Headquarters as soon as possible.

g.o.c.

ORDER OF BATTLE

SECRET

2000
177

As at 6 a.m. 2.7.18.

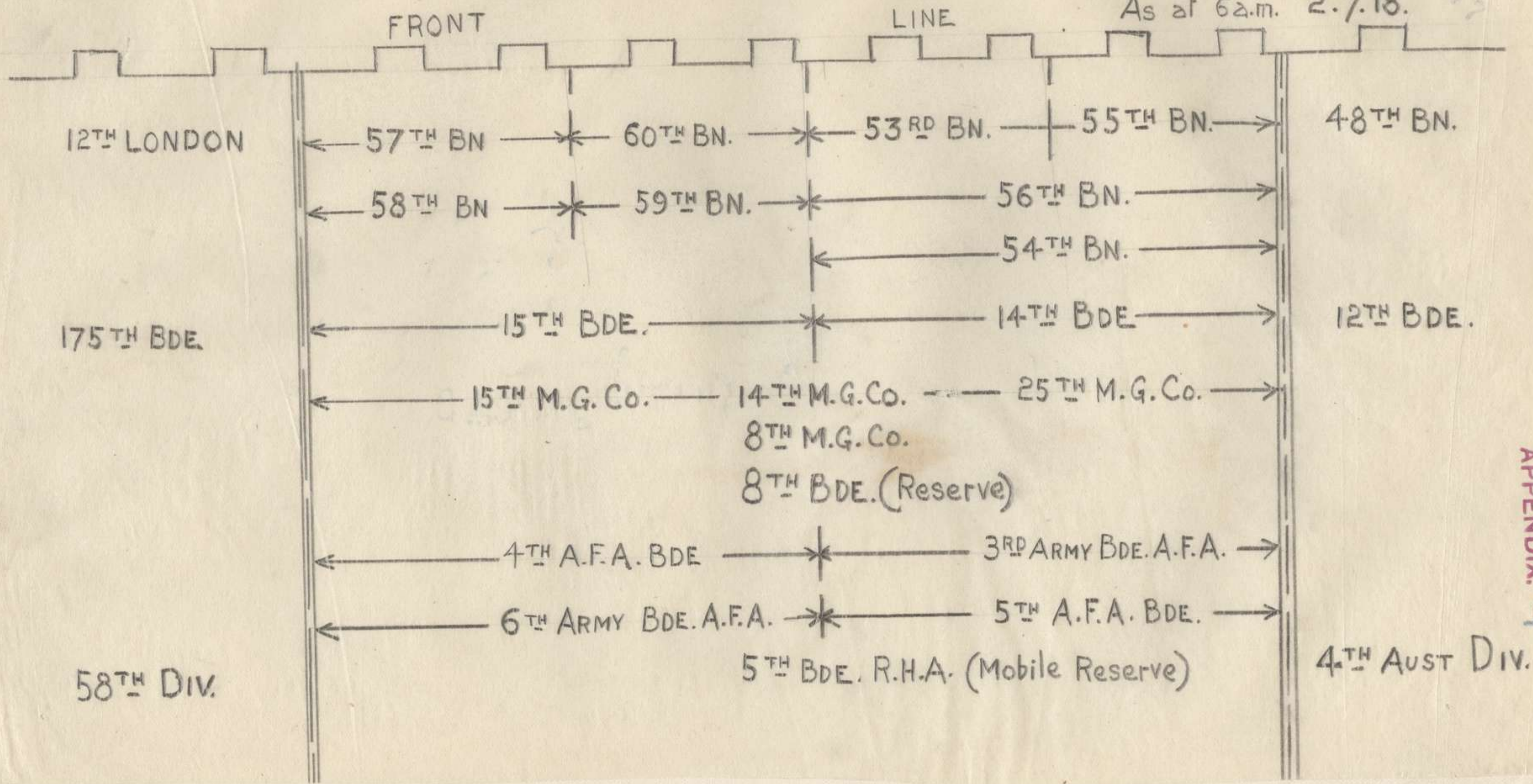

APPENDIX. 4

187

eswc

ORDER OF BATTLE

SECRET

As at 6 A.M. 6.7.18.

FRONT

LINE

12TH LONDON

← 57TH BN. * 59TH BN. * 53RD BN. — 56TH BN. — 54TH BN. →

48TH BN.

← 58TH BN. * 60TH BN. * ————— 55TH BN. ————— →

175TH BDE.

← 15TH BDE. ————— * ————— 14TH BDE ————— →

12TH BDE.

← 15TH M.G.Co. ————— 14TH M.G.Co. ————— 25TH M.G.Co. ————— →

8TH M.G.Co.

8TH BDE. (Reserve).

← 4TH A.F.A. BDE. ————— * ————— 3RD ARMY BDE. A.F.A. ————— →

58TH Div.

← 6TH ARMY BDE ————— * ————— 5TH A.F.A. BDE. ————— →

4TH AUST. Div.

5TH BDE. R.H.A. (Mobile Reserve).

WAR DIARY

APPENDIX. 4

149

War Diary

ORDER OF BATTLE

SECRET

233

As at 6 A.M. 8.7.18.

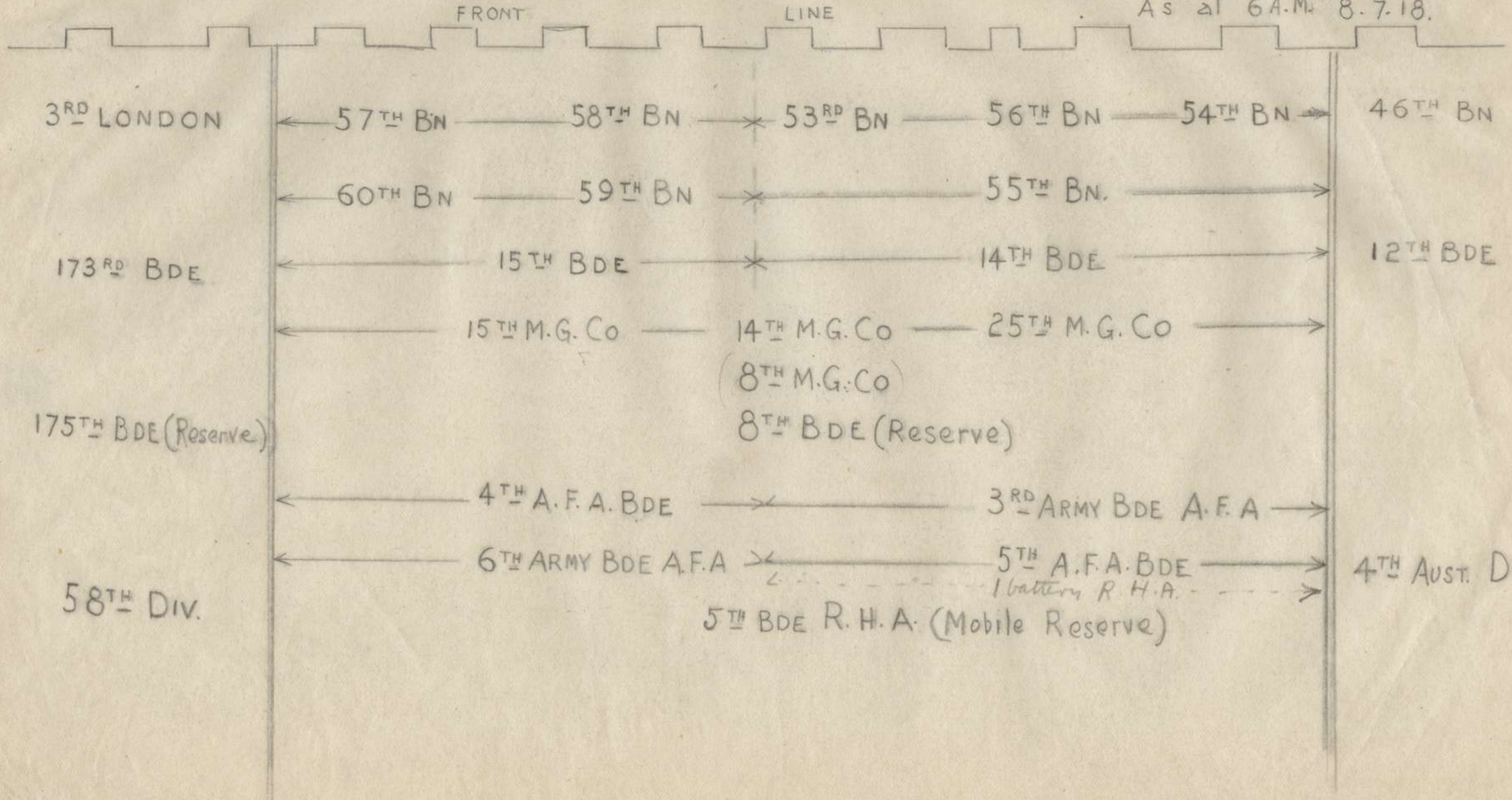

APPENDIX.

4

4

150

W.C. VA R. DIARY

ORDER OF BATTLE

SECRET

As at 6 A.M. 13.7.18.

238

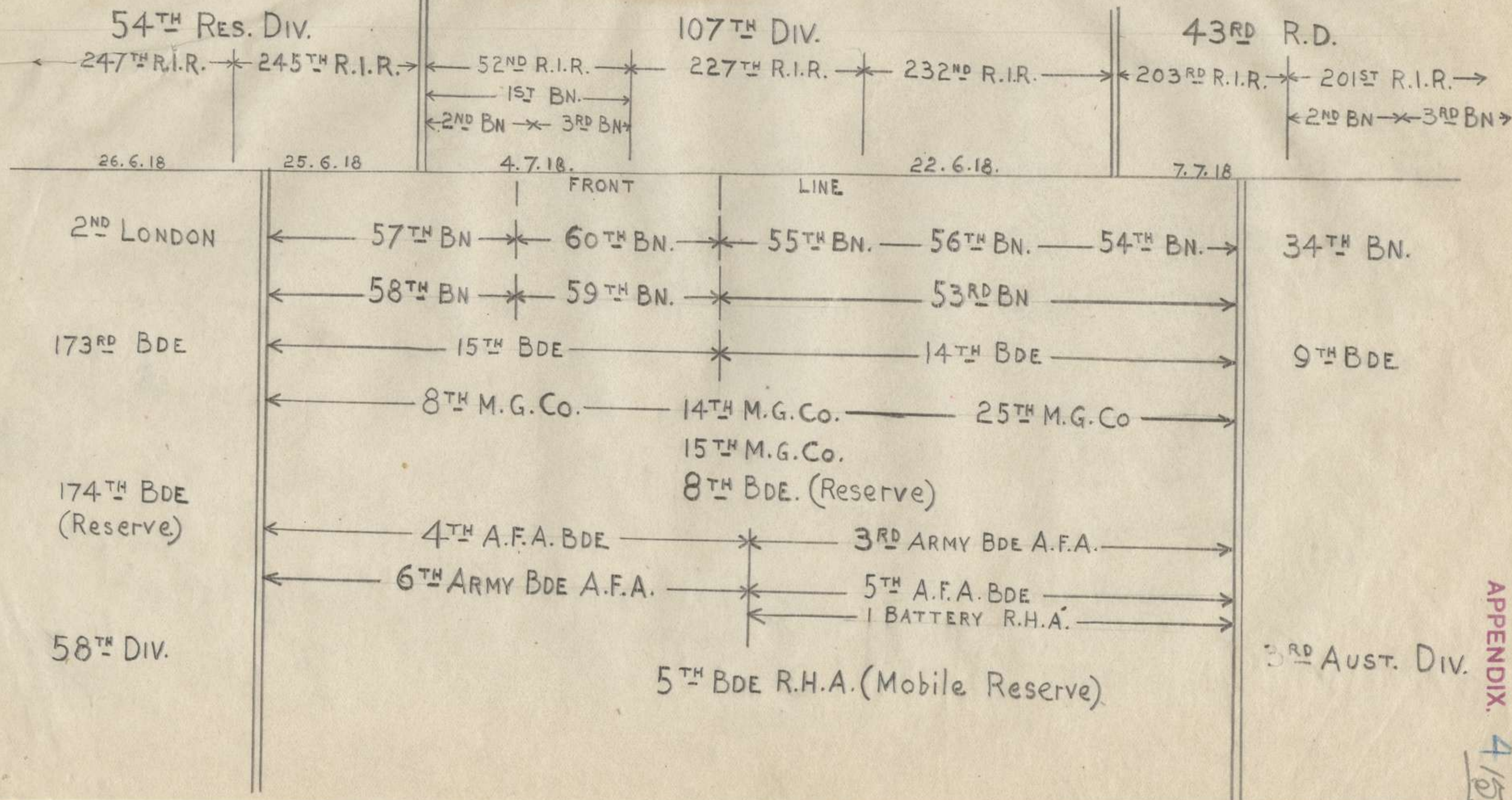

APPENDIX. 4/51

151

ORDER OF BATTLE

SECRET

As at 6 A.M. 12/1/10.

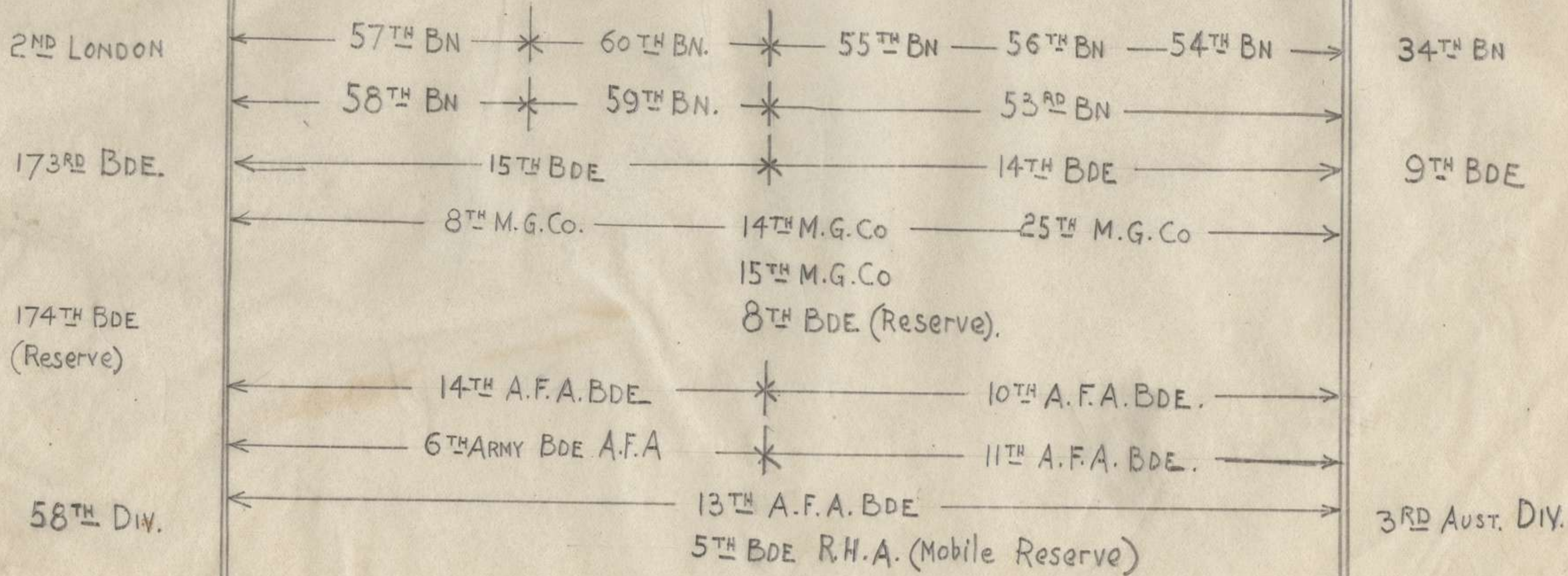
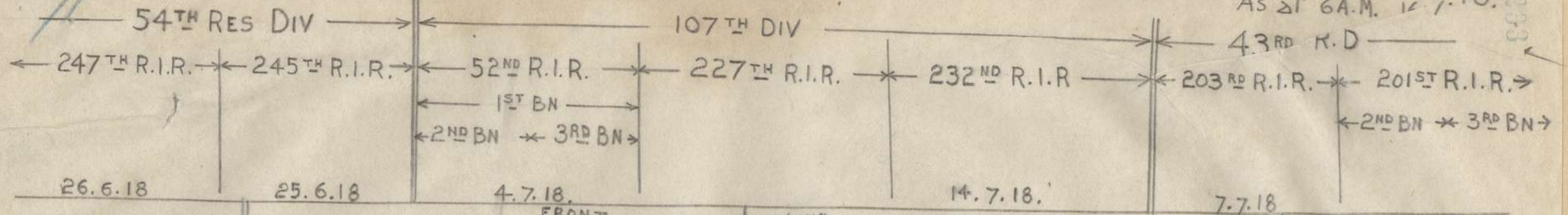

APPENDIX 4 152

g.c. War Plan

ORDER OF BATTLE

SECRET

As at 6 A.M. 18.7.18.

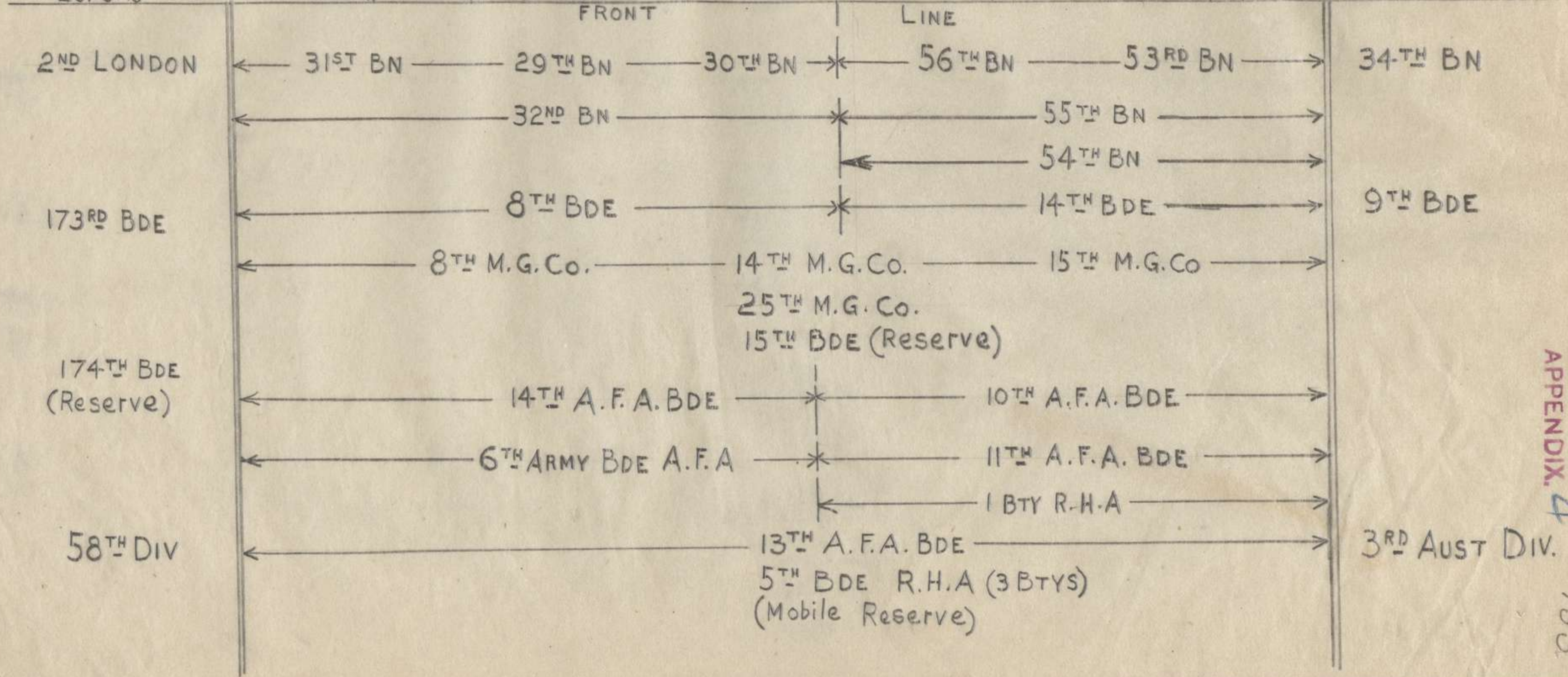
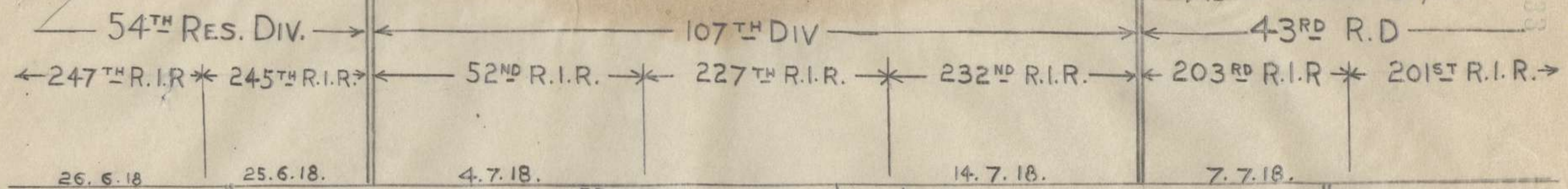

APPENDIX. 4

153

151

War Diary

ORDER OF BATTLE

SECRET

As at 6 A.M. 20.7.18

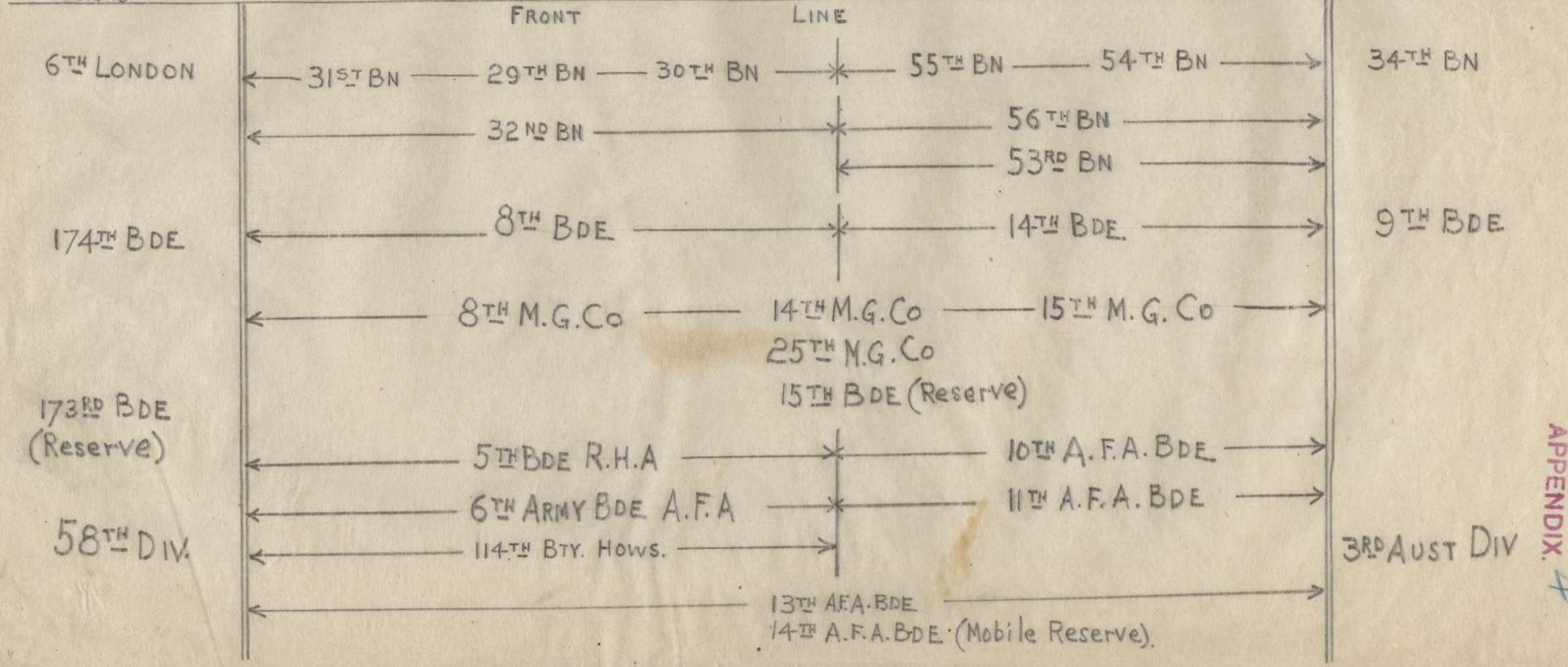
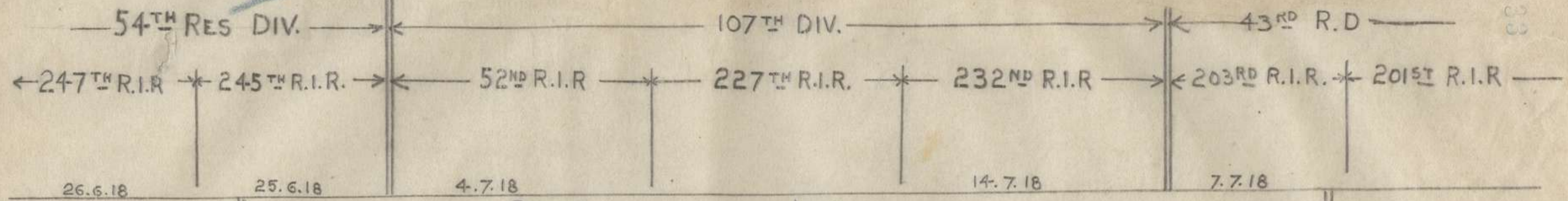

APPENDIX. 4 154

War Diary

ORDER OF BATTLE

SECRET

As at 6 A.M. 25.7.18.

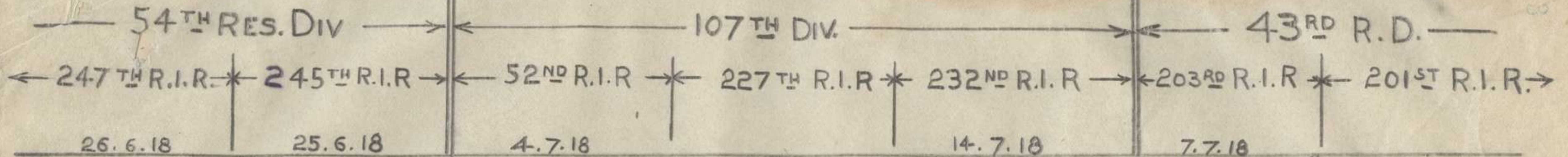

FRONT LINE

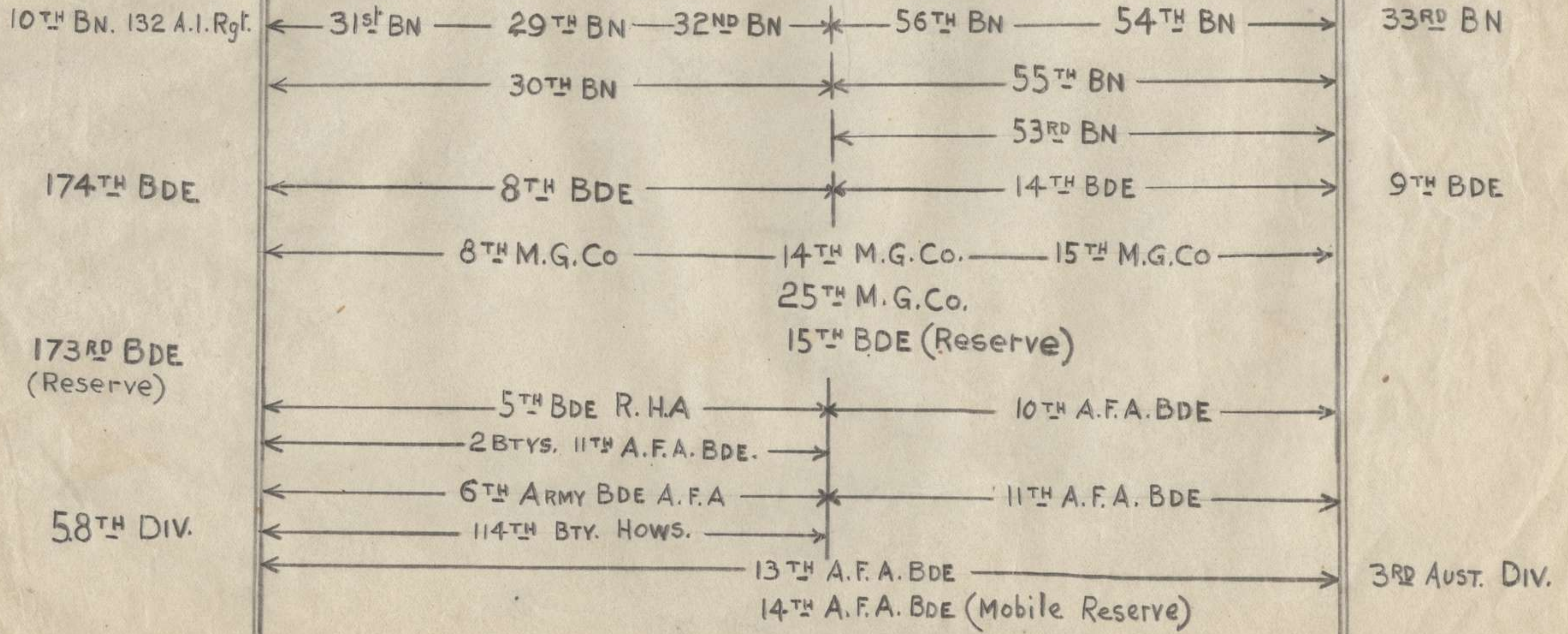

APPENDIX. 4

155

900
War Diary

ORDER OF BATTLE.

SECRET.

233

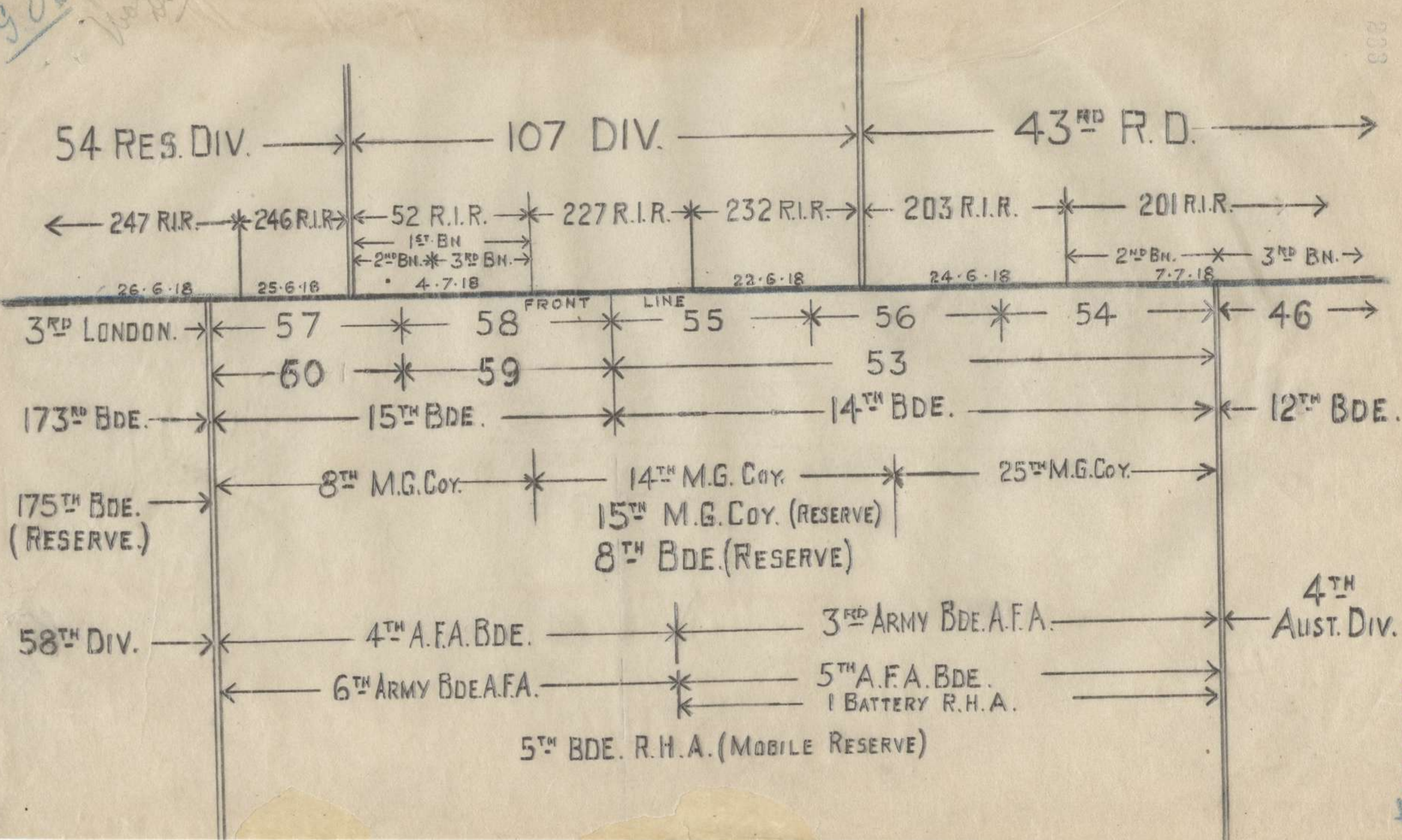

APPENDIX