

AWM4
Australian Imperial Force unit war diaries,
1914-18 War

Artillery

Item number: 13/35/21 Part 2

Title: Headquarters, 7th Australian Field
Artillery Brigade

July 1918



AWM4-13/35/21PART2

(S E C R E T)Copy No. *9*THIRD AUSTRALIAN DIVISIONAL ARTILLERY.

---O---

REF. MAPS:--
 Sheets 62 D; NE, SE, NW & SW.
 1/20,000.

-----O-----

" B " D I V I S I O N A L A R T I L L E R YD E F E N C E S C H E M E - AUSTRALIAN CORPS.

-----O-----

Previous "B" Divisional Artillery Defence Scheme, issued by 4th Aust. D.A.H.Q. on 12.7.1918, (WITH THE EXCEPTION OF DIAGRAMS "A" & "B" and PAGE 15 'Diagram of Communications', which should be inserted in this copy as Diagrams "A", "B" & "C" respectively) is hereby cancelled and should be destroyed.

Acknowledge receipt on form enclosed.

Headquarters.
 18.7.1918.

W.A. Nicholls
 Major, R.A.;
 B.M., R.A., 3rd Aust. Division.

DISTRIBUTION.

	<u>Copy No.</u>		<u>Copy No.</u>
R.A.; Aust. Corps.	1	69th R.G.A.	41
H.A.; Aust. Corps.	2	51st Bde, R.G.A.	42
"B" Div. G. (3rd Aust)	3	3rd Sq. A.F.O.	43
C.B.S.O.; Aust. Corps.	4	C. R. A.	44
Right Art. Grp.	5/13	B.M., R.A.	45
Left Art. Grp.	14/23	Asst B.M.	46
Superimposed Art. Grp.	24/28	Staff Optn, R.A.	47
Reserve Art. Bde.	29/33	R.A. Sig. Ofcr.	48
3rd Aust. D.T.M.O.	34	R.O., R.A.	49
3rd Aust. D.A.C.	35	War Diary.	50, 51, 52
Right Inf Bde (9th)	36	File	53
Left Inf. Bde (10th)	37		
Reserve Inf. Bde (11th)	38	15th Kite Bal. Coy.	54
"A" Aust. Div. Art. (2nd)	39	16th Kite Bal.	55
"C" Aust. Div. Art (5th)	40		

-----O-----

TO BE HANDED OVER ON RELIEF.

----- I N D E X -----

<u>Section</u>		<u>Page No.</u>
1.	GENERAL (Diagrams "A" and "B").	3
2.	ARTILLERY ORGANISATION.	3 & 4
3.	GENERAL POLICY.	4
4.	S. O. S.	5
5.	LIAISON ARRANGEMENTS.	6
6.	COUNTER-PREPARATION.	6, 7, & 8
7.	O.Ps.	8
8.	MUTUAL SUPPORT.	8
9.	ORDERS IN THE EVENT OF IT BECOMING NECESSARY TO OCCUPY SUCCESSIVE LINES OF DEFENCE.	8
10.	BATTERY POSITIONS COVERING SUCCESSIVE LINES OF DEFENCE.	9
11.	ANTI-TANK AND DEFENCE AGAINST LOW- FLYING AEROPLANES.	10
12.	CO-OPERATION WITH AEROPLANES.	10
13.	COMMUNICATIONS.	10
14.	TRENCH MORTARS.	10 & 11
15.	AMMUNITION SUPPLY.	11
16.	BRIDGES & DESCRIPTIONS.	12

DIAGRAMS "A", "B", "C" & "D".

Diagram "A" and "B" to be taken out of "B" Div. Art. Defence Scheme issued by 4th D. Art on 12.7.1918, and attached to this copy as Diagrams "A" and "B".
Page 15 to be taken out of "B" Div. Art. Defence Scheme issued by 4th D. Art on 12.7.1918, and attached to this copy as Diagram "C" (Communications).

133
The Southern Divisional Boundary is now, (as amended 35
by Right Group. G.5/311. 3/8/48. APPENDIX 80

From Front Line at P.21.b.1.3. to Cross Roads at P.21.a.3.0.--
thence WESTERLY along SOUTHERN SIDE of Road to O.11.a.6.1.--
thence to O.10.b.00.30. and WESTERLY along South of Road
running through AUBIGNY to DAOURS, then SOUTH OF DAOURS
Church, to Road at N.12.a.3.8. - then following the SOUTH side
of Road through N.9, N.10, N.11.e. abd d. to M.11.d. - then
NORTH WESTERLY through M.10.b

DANK OF THE SOMME CANAL.

2. INFANTRY. - The front is held by two Infantry Brigades:-
The RIGHT Infantry Brigade has two Battalions in the line.
The Left Infantry Brigade " " " " " "

3. BOUNDARY:- The "BOUNDARY" - The Inter-Brigade boundary is
P.3 and P.9. to P junction of roads O.11.a.6.2. - O.12.c.0.0. -
O.12.d.7.0. - O.12.b.6.3. - P.2. .8.3. - P.8.cent
to P.16.b.4.8." c

4. INFANTRY LOCATIONS:-
Right Infantry Brigade H. Qrs - O.12.b.9.3.
Left " " " " - J.19.c.3.6.

5. FORWARD LINES:-

Tracing "A" showing Front and Support Line, also the
Intermediate and Reserve Line.

6. REAR LINES OF DEFENCE:-

Tracing "B" showing rear Lines of Defence, which are:-
AUBIGNY - ANCRE LINE.
BLANGY - LAHOUSOYE LINE.
GLISY - QUERRIEU LINE.

7. FLANK DIVISIONS:-

The Division on the Right is "A" Division, Aust. Corps.
" " " " Left " " " " " "

18TH DIV. III CORPS.

SECTION 2. (ARTILLERY ORGANISATION)

1. Composition of Groups, "B" Divisional covering Artillery, is
as follows:-

The Right Group.- consists of two Field Artillery Brigades.

The Left Group - consists of two Field Artillery Brigades.

The Superimposed Group. - consists of one Field Artly Brigade.
Reserve Brigade. - consists of 1 Field Artly Bde.

2. "BOUNDARIES - Inter-Group boundary is as follows:-
Junction of roads O.11.a.6.2. - O.12.c.0.0. - line through
O.12.d.7.0. - O.12.b.6.3. - P.2. .8.3. -
P.8.central to P.16.b.4.8." c

3. The Right & Left Groups are responsible for the defence, engaging
all targets, answering wireless calls and harassing within their
zones.

The Superimposed Group is responsible for assisting in the
defence; will answer all S.O.S. Signals, L.L. and G.F. calls, but
will NOT answer N.F. Calls.

The Reserve Brigade in Wagon Lines will carry out Mobile Training,
and be kept as a Mobile Reserve at the disposal of the Division and
be used as occasion demands by the C.R.A.

All Officers are to make a thorough reconnaissance of the Divisional
Area, so that Batteries may be brought into action, whenever required,
without delay.

4. HEAVY ARTILLERY.-

BOMBARDMENT BRIGADE.

- (a) The 69th Bde, R.G.A. (H. Qrs - O.2.a.9.6.) is affiliated
to "B" Division for immediate bombardment purposes.
(b) In the event of mobile warfare conditions being re-
sumed by the Aust. Corps, the 51st Bde, R.G.A. (Head-
quarters - C.25.central) will come under the orders of
"B" Aust. Division in place of 69th Bde, R.G.A.

SECTION 1.

1. "B" Divisional Boundaries are :-
On the South - East & West along the grid line through P.20, central.
 "On the North - H.22.b.1.7. - H.24.a.9.8. - I.26.b.3.0. - J.25.a.0.0., thence Eastwards along the Northern bank of the SOMME Canal."
2. INFANTRY. - The front is held by two Infantry Brigades:-
 The RIGHT Infantry Brigade has two Battalions in the line.
 The Left Infantry Brigade " " " " " "
3. BOUNDARY:- The junction of roads O.11.a.6.2. - O.12.c.0.0. - P.3 and P.9. to P.0.12.d.7.0. - O.12.b.6.3. - P.2. .8.3. - P.8.cent to P.16.b.4.8."
4. INFANTRY LOCATIONS:-
 Right Infantry Brigade H. Qrs - O.12.b.9.3.
 Left " " " " - J.19.c.3.6.
5. FORWARD LINES:-
 Tracing "A" showing Front and Support Line, also the Intermediate and Reserve Line.
6. REAR LINES OF DEFENCE:-
 Tracing "B" showing rear Lines of Defence, which are:-
 AUBIGNY - ANCRE LINE.
 BLANGY - LAHOUSOYE LINE.
 GLISY - QUERRIEU LINE.
7. FLANK DIVISIONS:-
 The Division on the Right is "A" Division, Aust. Corps.
 " " " " Left " " " " " "

18TH DIV. III CORPS.

SECTION 2. (ARTILLERY ORGANISATION)

1. Composition of Groups, "B" Divisional covering Artillery, is as follows:-
The Right Group. - consists of two Field Artillery Brigades.
The Left Group - consists of two Field Artillery Brigades.
The Superimposed Group. - consists of one Field Artly Brigade.
Reserve Brigade. - consists of 1 Field Artly Bde.
2. "BOUNDARIES - Inter-Group boundary is as follows:-
 Junction of roads O.11.a.6.2. - O.12.c.0.0. - line through O.12.d.7.0. - O.12.b.6.3. - P.2. .8.3. - P.8.central to P.16.b.4.8."
3. The Right & Left Groups are responsible for the defence, engaging all targets, answering wireless calls and harassing within their zones.
The Superimposed Group is responsible for assisting in the defence; will answer all S.O.S. Signals, L.L. and G.F. calls, but will NOT answer N.F. Calls.
The Reserve Brigade in Wagon Lines will carry out Mobile Training, and be kept as a Mobile Reserve at the disposal of the Division and be used as occasion demands by the C.R.A.
 All Officers are to make a thorough reconnaissance of the Divisional Area, so that Batteries may be brought into action, whenever required, without delay.
4. HEAVY ARTILLERY.-
BOMBARDMENT BRIGADE.
 (a) The 69th Bde, R.G.A. (H.Qrs - O.2.a.9.6.) is affiliated to "B" Division for immediate bombardment purposes;
 (b) In the event of mobile warfare conditions being resumed by the Aust. Corps, the 51st Bde, R.G.A. (Headquarters - C.25.central) will come under the orders of "B" Aust. Division in place of 69th Bde, R.G.A.

Amended 3/8/18

4. Heavy Artly (contd)Counter Batteries.

The Australian Corps Counter-Battery Officer is at G.24.b.2.6.

All hostile shelling is to be immediately reported to Aust. Corps C.B., through Group Headquarters, or through Headquarters "B" Divisional Artillery - whichever is the quicker.

Information required by the Aust. Corps C.B. is as follows:-

- | | |
|--|-----------------------------------|
| (1) Unit calling. | (2) Number and calibre of hostile |
| (3) Time of hostile shellings. | gas or howe firing. |
| (4) Locality shelled. | (5) Rate of fire. |
| (6) Direction from which the hostile shelling is coming. When possible this should be given in grid line bearings and the place stated from which the bearing is taken, and whether the bearing is sound or flash. | |

The C.B. Officer must be informed of the continuance - or otherwise - of all hostile shelling reported. All hostile shelling will be reported whether it affects the Unit's own area or not.

5. LOCATIONS.

A statement showing the locations of all Units of "B" Divisional Artillery will be published from time to time.

SECTION 3. - POLICY. -1. Harassing Fire.

Vigorous harassing fire will be maintained upon all enemy approaches to his forward areas. This will be carried out under Group orders.

BY DAY it will be observed where possible, the utmost vigilance being maintained and every opportunity taken to inflict casualties upon the enemy and to promptly engage all hostile movement.

BY NIGHT and when observation is impossible it will be directed in accordance with carefully prepared schemes which will be varied daily.

The D.T.M.O. will in the same way with the T.M. Batteries harass and destroy the enemy trenches and works within range.

The essential principle of harassing fire should be to apply with vigour to the enemy that nature and method of fire which would be most injurious and demoralising if applied to ourselves.

2. AMMUNITION EXPENDITURE.

Ammunition allotment will be notified from D.A.H.Q. from time to time. A plentiful supply of Chemical Shell is available and every effort should be made to take advantage of all occasions when this class of shell can be used.

3. RELIEF OF PERSONNEL.

The Batteries, as far as possible, will be organised into two reliefs, each relief being sufficient to maintain the service of the Battery and to allow for slight casualties. Not more than one relief should be kept at the Battery position. The second should be within easy reach of the Battery.

4. PROTECTION.

The provision of shell and gas proof dugouts for Officers and men at O.Ps., Command Posts and Battery positions is to be proceeded with. All precautions will be taken for protection against bombing at gun positions, rest positions and Wagon Lines. Labor will normally be found by Batteries, but assistance will be provided as required by the Divisional Engineers.

5. FORWARD WAGON LINES will be selected and clearly marked with a notice board - "RESERVED FOR -- BTY. FORWARD W.L."

These Wagon Lines need not necessarily be occupied whilst main Wagon Lines are situated within reasonable distance with good approaches to Battery positions.

SECTION 4 - (S.O.S.) -----
133.

1. S.O.S. Line. - The S.O.S. Line covering Divisional front is:-
P.22.a.2.0. P.16.d.50.40. P.17.a.36.66. P.11.d.80.55.
P.11.b.35.00. P.5.d.73.00. P.6.d.20.83. P.6.c.20.95.
P.6.a.75.68. J.36.d.00.45. J.36.b.75.44.
2. RESPONSIBILITY.- The Right and Left Groups will cover the S.O.S. line within Group Zones.
Howitzers will be allotted definite objectives 200 yards beyond the 18-pdr S.O.S. line.
The Superimposed Group will superimpose the whole Divisional front, and will be prepared to switch on to any "lane" or "lanes" as ordered from D.A.H.Q.
3. THE SIGNAL. - The S.O.S. Signal is a coloured rocket or rifle grenade, the color being varied periodically.
4. In foggy weather, when there is a doubt of the possibility of S.O.S. Signals being seen, Group Commanders may, in the event of a heavy hostile bombardment of the front system, order S.O.S. fire to be opened, if they consider the situation demands this action.
5. LOCATION OF S.O.S. - All Batteries will maintain an S.O.S. sentry, whose duty it is to watch for signals from the vicinity of Battery position.
Pointers showing Divisional and Inter-Group boundaries at their intersection with the front line will be provided at each Battery.
6. PROCEDURE.- On receipt of an S.O.S. Signal or message, fire will be opened at once at the following rates on the S.O.S. barrage lines and Howitzer objectives:-
First 8 mins. - 4 rds per gun or how per min.
Next 7 mins. - 3 " " " " " "
Ammunition.- 18-pdr - 60% A 40% AX.
4.5" How. 106 fuze when available.
Fire will cease after 15 mins unless the S.O.S. Signal is repeated, when the programme will be at once started afresh as for first 8 minutes.
The above provisions are not to be taken as limiting either Group or Battery Commanders from developing the full fire power of their Batteries in the event of their knowledge of the situation demanding it.
7. CONFIRMATION OF S.O.S. SIGNAL. - If an S.O.S. call is received by signal it will be confirmed by wire as soon as possible.
If a signal is seen or an S.O.S. message received, all Units from Batteries upwards will inform the corresponding Unit on each flank and then their immediate superior.
All Officers must clearly understand that it is their duty to obtain immediate information as to the situation and to forward timed reports as to the situation to their superior; e.g., Batteries to Groups and Groups to D.A.H.Q. It is only by this means that the necessary concentration of Artillery can be procured.
8. GAS ALARM. - In the event of G A S being received, the ordinary warnings will be sent, precautions taken and Howitzers turned on to trenches or points whence the gas is being sent.
If S.O.S. is sent later, the ordinary S.O.S. procedure will take place.
9. SMOKE. - Should the enemy put down a smoke barrage on the front of this Division, a slow rate of fire will be opened, searching back over the area concealed from view. H.E. will be used.

SECTION 5. (LIAISON ARRANGEMENTS)

(a) With Infantry Brigade Headquarters.

The Right and Left Groups will each provide one Officer, not below the rank of Captain, to act as Liaison Officer with the Right and Left Infantry Brigade Headquarters, respectively.

Each Officer will be in direct communication with his own Group Headquarters.

These Officers will be provided with a map showing the S.O.S. line of the Divisional Artillery and the zone of each Group covering the Infantry Brigade front. Their duties will be to advise the Infantry Brigade Commander of the possibilities of Artillery action and to keep the Group Commander informed of the situation and the Infantry requirements as far as the particular Infantry Brigade front is concerned; but will communicate direct with D.A.H.Q. when the requirements are such as to involve more than the particular Infantry Brigade front.

(b) With Infantry Battalion Headquarters.

During the hours of darkness, Liaison will be provided as follows:-

Right Group. - One subaltern with each Battalion in the line of the Right Infantry Brigade.

Left Group. - One subaltern with each Battalion in the line of the Left Infantry Brigade.

These Officers will be provided with a map showing zones and S.O.S. of Batteries covering the Battalion front of the Batteries next on the Battalion flanks, in the case of Batteries of this Division. Their duties will be to keep the Group Commander informed of the situation and of all special targets in the immediate front which the Battalion Commander requires engaged.

SECTION 6. (COUNTER PREPARATION)

1. Counter Preparation will be ordered from D.A.H.Q., who will normally have received orders from Division or Corps, and will involve the delivery of a maximum of Counter-Battery work and Harassing Fire in one stage and a maximum of annihilating fire in another stage. Orders therefore to

"EFFECT C.P. SCHEME PHASE 1 A" will mean a maximum of Counter Battery fire.

"EFFECT C.P. SCHEME PHASE 1 B" will mean a maximum of harassing fire, and

"EFFECT C.P. SCHEME PHASE 2" will mean a maximum of annihilating fire.

(a) COUNTER PREPARATION SCHEME PHASE 1 B"

On receipt of the order "EFFECT C.P. SCHEME PHASE 1 B" Groups will concentrate in short bursts of fire on to all known and possible assembly areas in quick succession.

"The whole of Zone 'A' and Zone 'B' in C.P. Group Lanes mentioned in sub-para (b) hereunder will be subjected to this fire." time to time,

Rates of fire will be ordered at the time the Scheme is put into operation, and are as follows:-

RATE A.	60	rds	per	gun	or	how	per	hour.
RATE B.	30	"	"	"	"	"	"	"
RATE C.	15	"	"	"	"	"	"	"

AMMUNITION:

18-pdrs. 60% A, 40% AX.
4.5" Hows. 100% BX : 106 fuzes. (Gas shell when weather conditions & proximity to our line permit.)

COUNTER PREPARATION. (Contd).(b) COUNTER PREPARATION SCHEME PHASE 2.

SUBSTITUTE - "The Divisional front is divided into 6 Lanes, bounded on the West by a line 100 yards East of the S.O.S. Line called the "START LINE", and on the North and South in all cases by the East and West Grid Lines. Lanes are numbered from RIGHT to LEFT, for example:-

Lane including P.22.b. will be Lane 34.
 " " P.17.c. " " " 33.
 " " portion of P.6.c. " " " 29.

Lanes 29, 30, 31 are allotted to LEFT Group for purposes of C.P.
 " 32, 33 & 34 are " " RIGHT " " " "

These LANES agree with those used by the Heavy Artillery. Lanes are divided into four Zones, each measuring 500 yards from West to East:-

Zone "A"	will be	START LINE	to	START LINE	plus	500.
" "B"	" "	" "	" "	" "	" "	1000
" "C"	" "	" "	" "	" "	" "	1500
" "D"	" "	" "	" "	" "	" "	2000.

On receipt of the order -

"EFFECT C.P. SCHEME PHASE 2, ZERO HOUR"

Batteries commencing at ZERO HOUR on the START LINE will creep Eastward in lifts of 100 yards per two minutes.

This order may be varied in order to place a barrage creeping Eastward or Westward in certain Lanes or Zones: In this case more detailed orders will be sent.

Rate of Fire. - 3 rds per gun per minute.
 2 " " how " "

Ammunition. - 18-pdr 60% A. 40% AX.
 4.5" Hows. H.E. 100% 106 fuzes.

(c) Should the enemy open a heavy bombardment on this front and communications be cut, the following C.P. Scheme will be automatically come into force:-

Zero Hour to Zero plus 1 hr. 30 mins.

C.P. Scheme Phase 1B at the rate of 30 rds per gun and how per hour on Zones "B" and "C".

Zero plus 1 hr 30 mins to Zero plus 1 hr 45 mins.

C.P. Scheme Phase 2 - Zone "C" - working Westwards.

Zero plus 1 hr 45 mins to Zero plus 2 hrs 30 mins.

C.P. Scheme Phase 1B at the rate of 30 rds per gun and how per hour on Zone "B".

Zero plus 2 hrs 30 mins to Zero plus 2 hrs 45 mins.

C.P. Scheme Phase 2 - Zone "A" - working Eastwards.

Zero plus 2 hrs 45 mins until receipt of S.O.S., - orders to cease fire - or hostile fire ceases.

C.P. Scheme Phase 1B at the rate of 30 rds per gun and how per hour will be continued with on Zones "A" and "B".

In Phase 1B only, and not in Phase 2, 4.5" Hows, if the wind is favorable, will use gas shell only, endeavouring to put up a gas barrage along the whole front.

On receipt of the S.O.S. Signal or message, all guns will open as laid down in instructions previously issued. After this fire has continued for 15 mins with shrapnel and H.E., 4.5" Hows will, if the wind is favorable, change to gas shell for 15 mins. H.E. will be used for the subsequent 30 mins and then, wind still being favorable, another change will be made to gas shell for the next 15 mins; changing back to H.E. for next 30 mins; and so on.

SECTION 6 - COUNTER PREPARATION (Contd).

ZERO HOUR will be wired; but in the event of communications being cut, it will be taken to be commencement of enemy's bombardment. Battery Commanders are to use their own discretion re this Zero Hour. As soon as communications permit, Zero Hour will be co-ordinated by Group Commanders.

100 rds per 18-pdr gun and 4.5" How., and 200 rds 4.5" How gas shell per Battery will be held at the guns in addition to allotment, in anticipation of F.E. Scheme.

SECTION 7. O.P.s.

1. Each Group will man one O.P. by day and night. Each Battery will man one O.P. by day.
2. LOG BOOKS will be kept at each Group and Battery O.P. in which the Officer on duty will enter date, time, enemy movement, targets engaged, any unusual occurrence or points of interest.
3. It is desirable that Artillery and Infantry Observers should work in conjunction. This will be arranged with the Infantry Brigade Headquarters by Groups whenever possible.

SECTION 8. MUTUAL SUPPORT.

1. A 50 yards overlap will be maintained in the S.O.S. barrage at the Divisional North and South Boundaries, and between Groups.
2. Groups will be prepared to engage the S.O.S. line of the adjoining Group.
3. Liaison Barrages with Front Divisional Artilleries consist of barrages on S.O.S. line opposite our own front, either on the entire front or on Sectors as may be required.

SECTION 9.

ACTION IN THE EVENT OF IT BECOMING NECESSARY TO OCCUPY SUCCESSIVE LINES OF DEFENCE.

1. Should it become necessary to occupy successive lines of defence normally, orders will be issued from D.A.H.Q. Should this not be possible, owing to the interruption of telephonic and other communications, Brigade Commanders will act upon their knowledge of the situation, notifying their Group and D.A.H.Q. at the earliest possible moment of any change in their positions.
In the above event, Brigades will be under the tactical control of Brigade Commanders with a specific task, namely, to delay the enemy to the last possible moment, afford maximum assistance to our Infantry and withdraw Batteries to come into action in successive positions.
2. One Battery per Brigade will cover the withdrawal of the remaining Batteries of the Brigade.
Brigades will keep in close touch with the G.O.C., Infantry Div H.Q., through the respective Liaison Officers, sending two orderlies per Brigade to report to the Liaison Officer concerned. If circumstances permit, the Arty Group Commander and the Infantry Brigade Commander should be in personal touch.
The Reserve Brigade will be utilised in accordance with Section 2 paragraph 3.
Frontage allotted to Brigades will be as in Section 2, but these instructions are not in any way to interfere with the initiative of Commanders of lower formations at the moment, who will seize every opportunity of inflicting loss on the enemy.
Positions covering the successive lines of defence are shown in Section 10, page 9.

The Right Grp will withdraw to North side of SOMME by DAOURS - List of Bridges is given in Section 16.

133

Lines of Defence.	BTY	LEFT GROUP				RIGHT GROUP.					
		Left Brigade	Wgn Ins.	Right Brigade	Wgn Ins.	Left Brigade	Wgn Ins.	Right Brigade	Wgn Ins.		
AUBIGNY- ANCRE LINE.	A	H.23:b:70:30.	Within	H.34:d:60:00.	Within	N.11:d:95:85.	Within	N.4:a:20:30.	Within		
	B	H.23:b:75:55.	Area	H.34:d:50:35.	Area	N.12:a:45:40.	Area	N.4:b:05:10.	Area		
	C	H.23:b:70:85.	G.H.23 &	H.28:d:40:40.	M.9.	N.17:a:50:30.	M.11.	N.4:b:45:45.	M.10 &		
	D	H.24.d:10:70.	G.H.24.	H.34.d:40:70.		N.17.d:80:80.		N.4.b:20:70.	M.11.		
BLANGY- LA HOUSOYE LINE.	A	H.21.c:10:45.	Within	H.34:d:60:00.	Within	N.13:b:65:30.	Within	(N.9.d:7:5(2))	Within		
	B	H.21:b:70:20.	Area	H.34:d:50:35.	Area	N.14.d:90:70.	Area	(N.6.c:3:3(4))	Area		
	C	H.21:b:90:10.	G.H.23 &	H.28:d:40:40.	M.9.	N.8.c:45:90.	M.11.	(N.7.d:85:05.)	M.10 &		
	D	H.21.c:50:65.	G.H.24.	H.34.d:40:70.		(N.13.d:45:80(2))		(N.9.d:6:8(2))	M.11.		
AUBIGNY- ANCRE LINE.	SUPERIMPOSED GROUP:		SPARE POSITIONS ARE AVAILABLE				Following are co-ordinates of O.Ps.				
		Group.	Wgn Ins.								
	A	H.23:d:60:80.	Within	H.23:d:80:15.	N.4:c:70:70.	No.					
	B	H.24.a:80:30.	Area	H.29:b:80:90.	N.4:c:80:90.	H.F.3. I.25.a:80:91.					
C	H.23:d:50:60.	H.7.	H.29:b:90:70.	N.4:b:00:90.	F.B.4. I.31.a:34:60.						
D	H.24.a:30:10.	H.13.	H.24.c:20:60.	N.4.a:80:50.	F.A.4. N.28.d:00:90.						
BLANGY- LA HOUSOYE LINE	A	N.2.a:40:50.	Within	N.3:d:90:55.	F.B.1. N.12.c:14:00.						
	B	H.32.c:65:10.	Area	N.3.d:50:90.	F.B.2. N.10.b:35:15.						
	C	H.32.c:90:55.	M.9 &	N.3.c:60:95.	F.B.5. H.36.b:80:80.						
	D	H.32.c:10:80.	M.10.	N.15.b:70:85.							

133

APPENDIX 35

86

87

35

Next ten minutes - 1 rd
First 5 minutes - 2 rds per mortar per minute.

opened as follows:-
S.O.S. - Each mortar is allotted by the D.T.M.O. in consultation with Artillery Group Commanders a definite target within enemy forward works. On receipt of an S.O.S. signal or message, fire will be

Locations are issued in Divisional Artillery Location Statements from time to time.

1. D.T.M.O. Headquarters in NEVILLE.
2. The M.T. Mortars consist of two Trench Mortar Batteries each of six 6-inch NEWTON MEDIUM Trench Mortars.
3. Two M.T.M. Batteries are in action with 4 M.T.Ms. in the line and 2 H.T.Ms. in reserve on each Brigade front. Personnel is provided by these Batteries to man the anti-tank guns.
4. Locations are issued in Divisional Artillery Location Statements from time to time.

SECTION 14 - MEDIUM TRENCH MORTARS.

Straight line DIAGRAM of COMMUNICATIONS (page 15 of old Defence Scheme, to be called DIAGRAM "Q") and placed in this scheme.

SECTION 13. - COMMUNICATIONS

P.28.00.00 - P.24.00.00 - P.18.00.00
P.18.00.00 - P.18.00.00 - P.18.00.00
K.26.00.00 - K.26.00.00 - K.26.00.00

L.T. CALLS will be answered by all Batteries. A burst of fire will consist of three Battery salvos. (That can be on the target). I.F. CALLS will be answered by a Battery to be detailed by Group Headquarters. Not more than 4 salvos will be expended unless the situation and observation received render it desirable to continue firing. In order to ensure one Battery only answers an N.F. Call the Battery detailed with only engage targets within its group boundaries. (a) Within its group boundaries. (b) West of the following dividing line between Field and Heavy Artillery -

SECTION 12. - CO-OPERATION WITH AEROPLANES.

Two Lewis guns per Battery will be maintained in action at Battery positions for defence against low-flying aeroplanes and they will be so sited that they can be used in the case of necessity to defend the Battery position from Infantry attack. Cover will be provided for the detachment.

SECTION 11. - ANTI-TANK BATTALIONS.

Three 15-pdr B.L.C. and two 6-pdr Hotchkiss guns are in action covering the "B" Divisional Front. These guns are manned by the Divisional Medium T.M. personnel, except one 15-pdr, which is manned by the Left Group. 100 rounds H.E. per gun will be kept at gun positions. These guns will not be fired except in the case of an enemy attack, in which case the normal target will be a hostile tank, but other targets will be engaged if the situation at the moment demands it.

ANTI-TANK DEFENCES AND DEFENCE AGAINST LOW-FLYING AEROPLANES.

SECTION 10. -

SECTION 14 (Medium T.Ms) - (Contd).

5. (contd):

S.O.S.

If the S.O.S. signal is again received after opening fire, the maximum rate will be reverted to and the above procedure carried out.

6. Destructive and harassing shoots will be carried out daily under orders of the D.T.M.O., who will obtain all information regarding the front and arrange the daily programme of targets to be engaged accordingly. It will be the duty of the D.T.M.O. to keep in close touch with Artillery Group Headquarters, Infantry Brigade Headquarters and Infantry Battalion Headquarters.

-----o-----o-----o-----

-- SECTION 15 - AMMUNITION SUPPLY. ---

1. Ammunition is taken on charge of Divisional Artillery on arrival at A.R.P. The supply thereto from Ammunition Railhead (FIESSELLES) is by

- (a) Motor Lorry.
- (b) Light Railway.

The amount to be kept at A.R.P. is governed by expenditure and is ordered daily through Corps "Q" by this office.

The A.R.Ps. for supply of the Artillery covering "B" Divisional Sector are situated at H.12.a.1.9. and H.22.b.2.8.

2. The supply forward of A.R.P. will be done by horse transport.

(A) In the case of Divisional Artillery, Brigades and D.A.C. Commanders will arrange mutually that the D.A.C. tender a proportionate assistance in ammunition carrying. D.A.C. will also supply G.S. Wagons on demand for the return of empties to A.R.P.

(B) In the case of Army Brigades, the supply and return of empties will be done under arrangements to be made by Os.C. concerned.

3. Brigades, etc., will draw from Dumps as per Administrative Instruction issued by D.A.H.Q.

4. The establishment to be kept at guns is as follows:-

Per 18-pdr & 15-pdr Gun.	400 rds.	[includes 100 rds extra per Bty for C.P.Scheme.]
4.5" How.	350 "	
4.5" How. Battery.	300 " (GAS)	

All Echelons filled.5. EMPTYES.

Brigade Commanders will ensure that all empties are returned to A.R.Ps. daily.

Emptyes from A.R.P. will be sent back to Railhead by lorry and Light Railway.

-----o-----o-----o-----

LIST OF BRIDGES & DESCRIPTIONS.

numbered in Groups & to be known by the name of the Group - together with the numbers of the bridges within the Group, e.g., BUSSY "3".
- Sheet 62 D. -

LOCATION.	NAME.	Description.	GROUP.	
O.1.d.3.0.	DAOURS 1	Road / Railway	DAOURS GROUP.	
O.1c.2.3.	" 3	Road / River		
O.1.o.2.5.	" 4	ditto		
O.1.a.2.1.	" 5	ditto		
O.1.a.1.1.	" 6	ditto		
H.6.2.8.3.	" 7	ditto		
H.6.d.0.5.	" e	ditto		
N.5.a.0.6.	11	ditto		
O.2.b.0.4.		DOMINANT BRIDGE.		
N.5.b.2.6.	BUSSY 1	Track / River.		BUSSY GROUP
N.5.b.1.9.	" 2	ditto		
H.29.c.4.2.	" 4	ditto		
H.23.b.2.2.	QUERRIEU 1	Track / Stream	QUERRIEU GROUP	
H.23.b.1.2.	" 2	ditto		
H.23.a.8.2.	" 3	Track / River		
H.17.a.0.6.	" 4	ditto		
H.17.b.0.1.	" 5	Road / River		
H.17.b.7.8.	" 6	Road / Stream		
H.17.b.8.6.	6a	Track / Stream		
H.17.b.4.5.	7	Road / River		
H.11.a.0.2.	8	Footpath / Stream		
H.11.b.7.2.	9	Track / River		
H.12.a.4.6.	9a	Track / Stream		
H.5.d.8.4.	10	Track / River		
J.2.c.5.1.	HILLY 1	Track / River	HILLY GROUP	
J.7.b.3.5.	" 2	Road / River		
J.7.b.2.7.	" 3	ditto		
J.7.cent.	" 4	Track / River		
I.29.a.	BONNAY 1 & 2	Track / River	BONNAY GROUP	
I.25.c.	" 3, 4, 5, 6.	ditto		
I.23.d.6.6.	" 7	Road / Railway		
I.25.b.6.4.	" 8	Road / River		
I.25.b.3.7.	" 9	Road / Stream		
I.18.c.	" 10, 11	Track / River		
	12, 13, 14.			
O.11.a.0.9.	CORBIE 2	Road / Stream	CORBIE GROUP	
O.5.c.3.2.	" 4	ditto		
O.5.c.4.5.	" 6	ditto		
O.5.c.7.0.	" 8	Road / River		
O.5.c.7.3.	" 9	ditto		
H.15.c.6.5.	BLANGY 1	Pontoon / River	BLANGY GROUP.	
H.15.c.6.2.	" 2	Pontoon / Stream		
H.15.b.7.4.	" 3	Road / River		
H.15.a.2.4.	" 4	Towpath / Stream		
H.15.c.8.4.	" 5	Towpath / Spillway		
H.15.c.7.4.	" 6	Trestle / Lock		
H.15.c.5.4.	" 7	Tow-path / Stream		
H.15.c.2.4.	" 8	Road / River		
H.15.c.1.3.	" 9	Trestle / Stream.		

133

DIAGRAM "A"

"B" DIV. AREA.

90

Ref. Maps 62^D N.E. and S.E. 1/20,000.



APPENDIX

35

-Tracing B-

B Div^l Arty. Defence Scheme -

- Ref. Map 622/40000. -

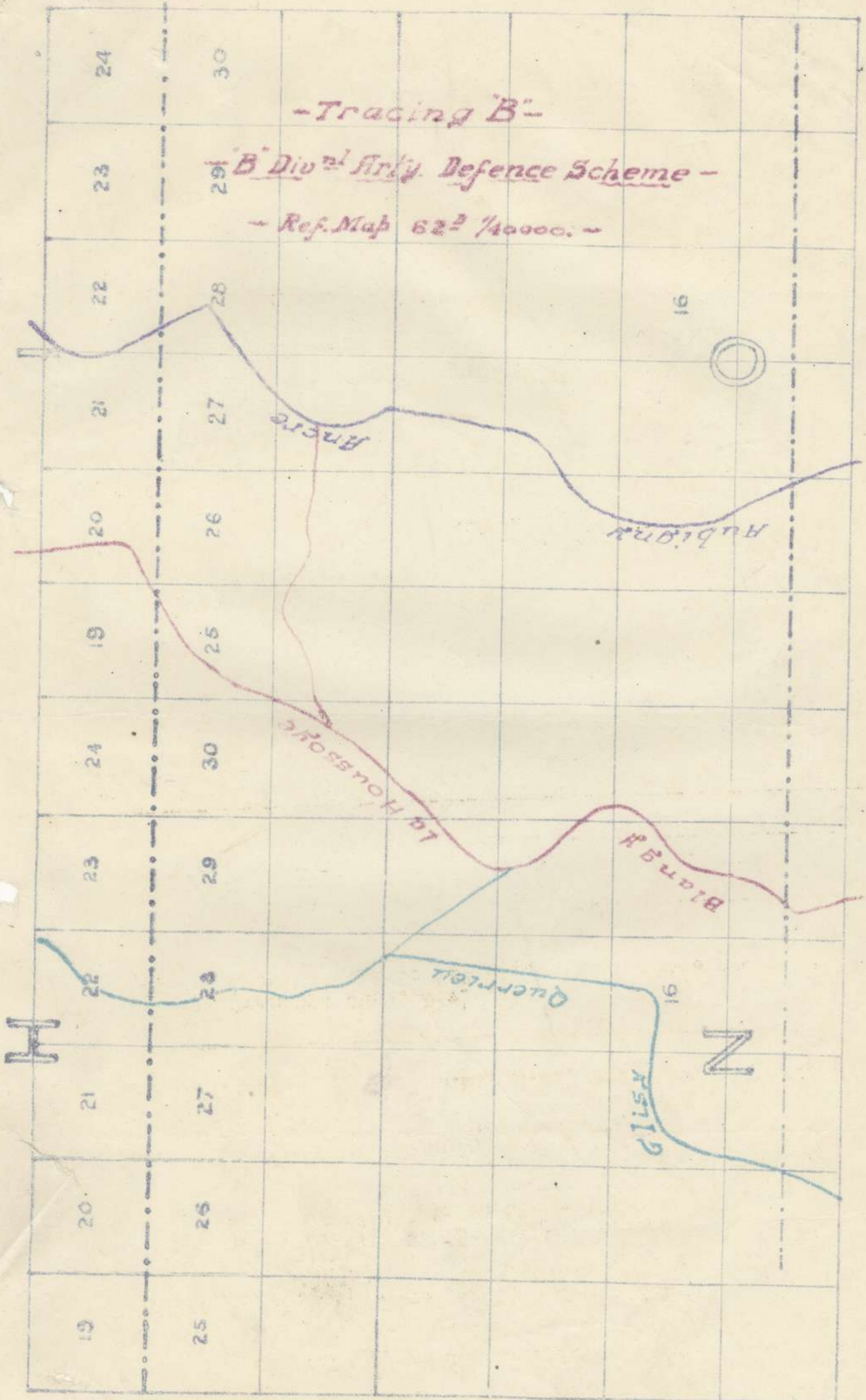

"B" DIVISIONAL ARTILLERY DEFENCE SCHEME.

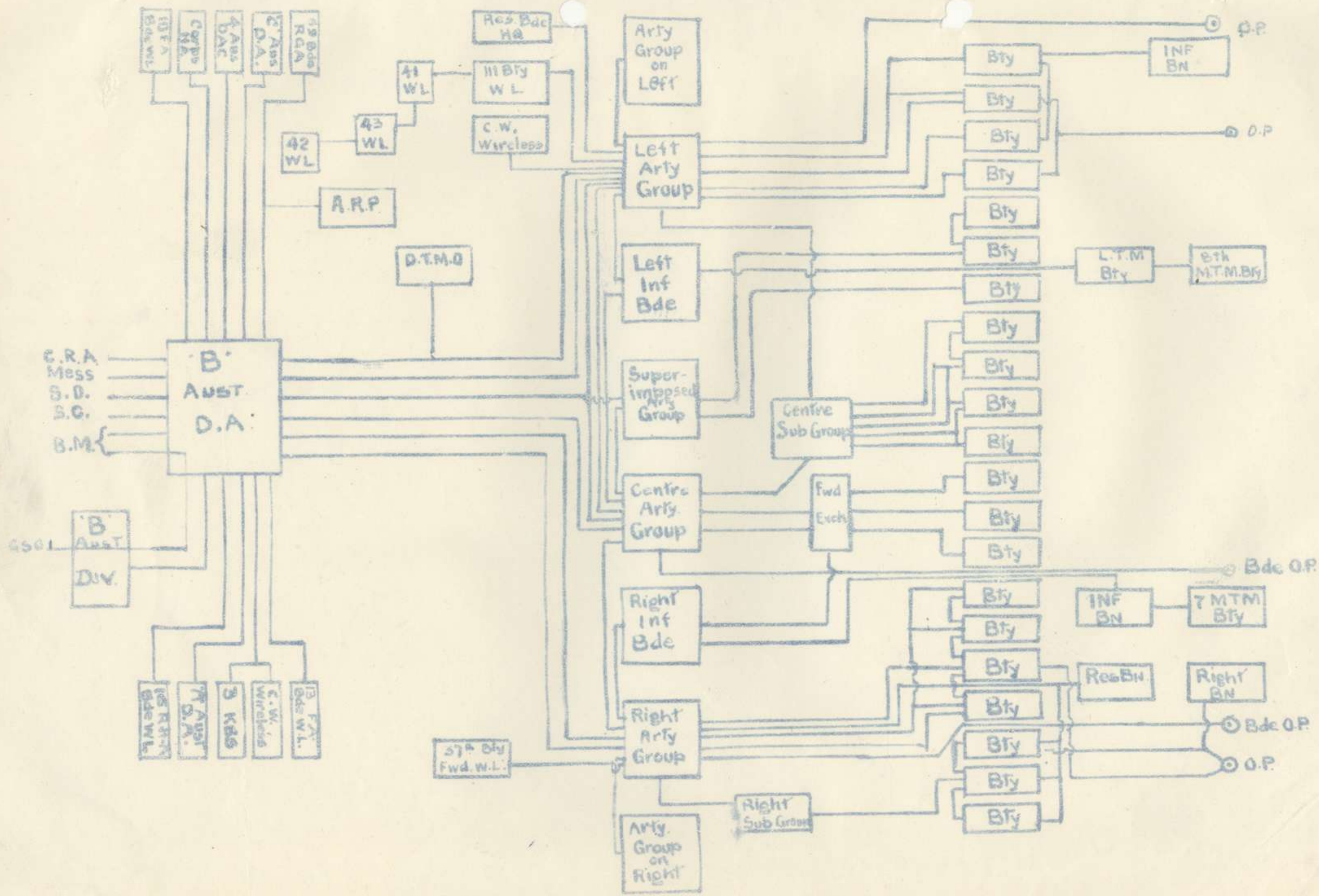

133 DIAGRAM.

APPENDIX 35

PAGE 15.

(SECRET)

*Entered
on various
pages RM
11/8/18*

Copy No. 10

THIRD AUSTRALIAN DIVISIONAL ARTILLERY.

901

ADDENDUM No. 2. to "B" Divisional Artillery Defence Scheme,
dated 18.7.1918.

Acknowledge receipt on form enclosed.

Headquarters:
31.7.1918.

J. Rowe Major,
for B.M., R.A., 3rd Aust. Division.

Distribution - To all recipients of "B" Div. Art. Defence Scheme

To Batteries 189 Bde + Sub Group

*Herewith copy of B Divisional
defence scheme dated 18.7.18
which cancels previous defence
scheme with the exceptions as stated.*

*This does not cancel the
NIGHT GROUP instructions No 1
+ appendices.*

*Accepted
for Capt + adj.
189 Bde 13/18*

189

Acknowledged ✓ C34

189TH
ARMY BRIGADE
R.F.A.
92/235
20.7.18

*5 Copies
No 9 - to 13*

Date- 25th July 1918.

133

"A" SUB GROUP ARTILLERY.

INSTRUCTION No.8.

1. The following notes are issued in amplification of "B" DIV. ARTY. DEFENCE SCHEME.

Section 3. para's 1 and 2 in accordance with instructions issued from time to time.

Section 4. para 1. S.O.S. line and zones are constantly changing and recourse must be had to orders and instructions issued regarding S.O.S.

Section 5. paras. a and b. - As per Roster issued from time to time.

Section 6. para (b) Lanes are allotted to Batteries in instructions issued.

Section 7. para. 1. Sub Group O.P. manned day and night, is at J.27.b.65.25.

Section 9. Attention is called to "Notes on Withdrawal" issued recently.
Any withdrawal will be a fighting one. There is no idea of giving up our forward system, and in the event of withdrawal, intermediate positions between present front system and AUBIGNY system will be occupied.

K.D. Watson Lieut.
Adjutant, A.Sub Group Artillery.

Distribution.-

~~Right Group.~~
26th Battery.
107th Battery.
WAR DIARY.

25th Battery.
27th Battery.
FILE.

133

"A" SUB GROUP ARTILLERY.TASK TABLE No.11.

Reference.- Tracing of Harassing Fire Targets, 1/20,000.
Sheet 62 D., issued with Task Table No. 3.

1. GAS BOMBARDMENT.

Times.	Target.	Shell.	Rate.	Battery.
10-0 to 10-2p.m.	34	Hows. BCG 18-Prs AX 106	GF 3rds p.g.p.m. 1 sec.	107th 27th
10-7 to 10-9p.m.	39	Hows. BCG 18-Prs AX 106	GF 3rds p.g.p.m. 1 sec.	107th 27th
10-14 to 10-16p.m.	49	Hows. BCG 18-Prs AX 106	GF 3rds p.g.p.m. 1 sec.	107th 27th
11-52 to 11-54p.m.	39	Hows. BCG 18-Prs AX 106	GF 3rds p.g.p.m. 1 sec.	107th 27th

2. Harassing fire up to extreme range and not closer than 400 yards East of S.O.S. Lines.
Bursts of Ten (10) rounds per Battery will be fired at the following times.-

Battery.	Times.
107th Battery.	9-10, 9-25, 9-35, 9-50p.m.
26th Battery.	10-5, 10-15, 10-35, 10-55, 11-10, 11-25 & 11-40p.m.
27th Battery.	2-5, 2-15, 2-25, 2-40, 2-55 a.m.
25th Battery.	3-10, 3-15, 3-25, 3-40, 3-55 and 4-5a.m.

Batteries are restricted to their Zones as for C.P.

K D Watson Lieut.,
Adjutant, A. Sub Group Artillery.

Distribution.-

Right Group.
26th Battery.
107th Battery.
WAR DIARY.

25th Battery.
27th Battery.
FILE.

A. Sub Group Artillery.
25th July, 1918.

To,
Battery Commanders.

Reference Task Table No. 11 of even date.:

Harassing fire may be carried out up to a line 100 yards
East of S.O.S. lines tonight.

K. Watson
Lieut.
Adjutant, A. Sub Group Artillery.

Date. - 26th July 1918.

"A" SUB GROUP ARTILLERY.TASK TABLE NO.12.

Reference - Tracing of Harassing Fire Targets, 1/20,000.
Sheet 62 D., issued with Task Table No.3.

1. BAS BOMBARDMENT.

Time	Target	Shell	Rate	Battery.
11. to 11.2 pm.	36	Hows BNC 18 pdrs. AX106	G.F. 3rds PGPM.	107th. 2 secs 25th.
11.3 to 11.5 pm.	36	Hows BCG. 18 pdrs AX106	G.F. 3rds PGPM.	107th. 2 secs 25th.
11.56 to 11.58 pm.	34	B.N.C.	G.F.	107th.
11.59 to 12.1.am.	34	B.C.G.	G.F.	107th.

2. Harassing Fire up to extreme range and not closer than ¹⁰⁰~~400~~ yards
EAST of S.O.S. Lines:-
Bursts of ten (10) rounds per Battery will be fired at the following times:-

Battery	Times.
25th Battery	- 9-pm., 9.20.pm., 9.35 pm., 9.55 pm., 10.10 pm., 10.20 pm.
26th Battery	- 10.25 pm., 10.35 pm., 11.15 pm., 11.35.pm.
27th Battery	- 2 am. 2.5 am. 2.15.am. 2.25.am. 2.40 am. 2.50.am.
107th Battery	- 2.55 am. 3.5 am. 3.15 am. 3.25 am. 3.40/am. 3.50 am.

Batteries are restricted to their Zones as for C.P.

K. D. Watson Lieutenant,
Adjutant, "A" Sub Group Artillery.

DISTRIBUTION:-

Right Group.
25th Battery.
26th Battery.
27th Battery.
107th Battery.
FILE.
WAR DIARY.

MESSAGES AND SIGNALS. No. of Message.....

Prefix.....	Code.....m.	Words.	Charge.	<i>This message is on use of:</i>	Recd. at.....m.
Office of Origin and Service Instructions		Sent	Service.	Date.....
		At.....m.			From.....
		To.....			By.....
		By.....		(Signature of "Franking Officer.")	By.....

TO {

Sender's Number. <i>ABCD</i>	Day of Month. <i>26</i>	In reply to Number.	AAA
------------------------------	-------------------------	---------------------	------------

** A188 26*

Ref Task Table No 12

para 1 ~~transmission~~ for times

lined down substitute the

following 1 AM 1-3 AM

1-56 AM 1-57 AM

From	Place	Time	<i>FUGU</i>
------	-------	------	-------------

The above may be forwarded as now corrected. (Z)

Censor..... Signature of Addressor or person authorised to telegraph in his name. *[Signature]*

* This line should be erased if not required.
 (7981) Wt. W492/M1647 130,000 Pads 5/17 D. D. & L. E1187

133

Date.- 27th July, 1918.

"A" SUB GROUP ARTILLERY.TASK TABLE NO. 13.

Reference - Tracing of Harassing Fire Targets, 1/20,000.
Sheet 62 D., issued with Task Table No. 3.

1. Harassing fire up to extreme range and not closer than 400 yards East of S.O.S. Lines.
Bursts of Ten (10) rounds per Battery, will be fired at the following times.:-

Battery.	Times.
27th Battery	- 8-55, 9-10, 9-25, 9-40, 9-55 and 10-5p.m.
25th Battery	- 10-10, 10-20, 10-35, 10-50, 11-10, 11-20, and 11-45p.m.
107th Battery	- 2-5, 2-15, 2-25, 2-35 and 2-40a.m.
26th Battery	-- 2-45, 3-0, 3-5, 3-15, 3-25, 3-40, and 3-45a.m.

Batteries are restricted to their Zones as for C.P.

K.D. Watson Lieutenant,
Adjutant, "A Sub Group Artillery.

Distribution-

Right Group,
25th Battery,
26th Battery,
27th Battery,
107th Battery,
FILE.
WAR DIARY.

"C" Form.
MESSAGES AND SIGNALS.

Army Form C. 2123
(In books of 100.)

No. of Message.....

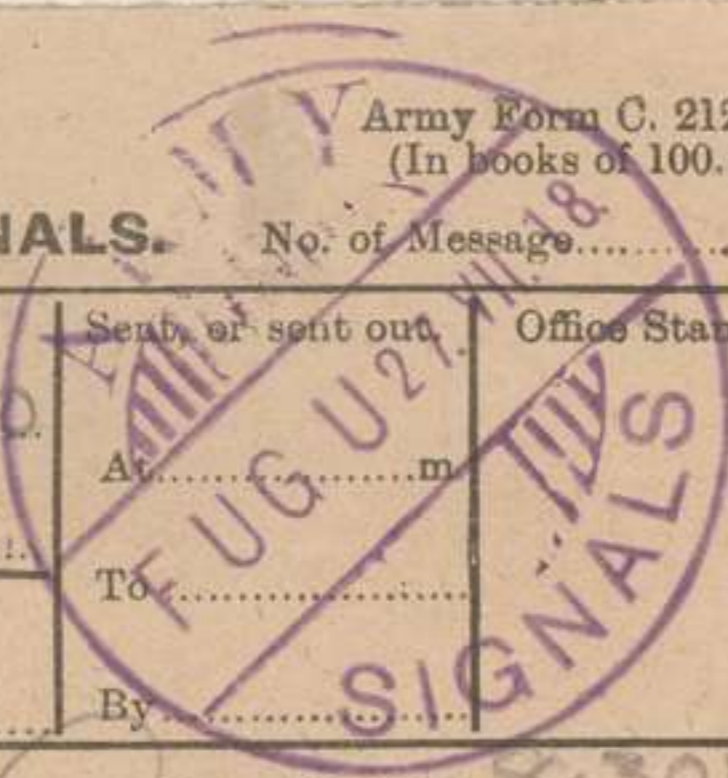
Prefix.....	Code.....	Words.....	Received.	Sent, or sent out.	Office Stamp.
£ s d. Charges to Collect 17			From Humo	At.....m	
Service Instructions. Humo			By Gun	To.....	
			By.....	By.....	

Handed in at..... Office..... m. Received 8.30 p.m.

TO "A" Sub Group

*Sender's Number AW61	Day of Month 24	In reply to Number	AAA
Boassing fin to-night will be confined to metalled roads			
979			

FROM Right Group

TIME & PLACE

*This line should be erased if not required.

C. & H. 7330 Wt. W14832/M/1523 100,000. 3/17. (E930). Forms C/2123.

Date.- 28th July 1918. APPENDIX

39 101

"A" SUB GROUP ARTILLERY.

TASK TABLE No. 14.

1. In conjunction with operations on C. Divisional Front, 18-Pdr. Batteries of Right Group will carry out a diversion on night of 28/29th July, 1918.
2. Zero hour will be notified later.
3. At Zero, 18-Pdr. Batteries of the 7th Brigade, commencing on line 100 yards East of S.O.S. Line and working in own Zones, will advance EASTWARDS at the rate of 100 yards every three (3) minutes until Zero plus 15, when fire ceases.
Zero to Zero plus 3 - Start Line.
Zero plus 3 to Zero plus 6 - Start Line plus 100. and so on until Zero plus 15.
Rate two rounds per ~~minute~~ gun per minute.
4. At Zero plus 54, 18-Pdr. Batteries will proceed as in para. 3, except that the "creep" will be 100 yards every two (2) minutes until Zero plus 70 when fire ceases.
Zero plus 54 to Zero plus 56 - Start Line
Zero plus 56 to Zero plus 58 - Start Line plus 100. and so on until Zero plus 70.
Rate 1 round per gun per minute.
5. Ammunition. 60% A, 40% AX (not 106 fuzes)
6. Acknowledge by wire.

K.D. Watson Lieutenant,
Adjutant "A" Sub Group Artillery.

Distribution.

25th Battery,
26th Battery,
27th Battery,
107th Battery. (for information)
FILE
WAR DIARY.

Zero Hour 12-30 AM 29th inst sent to
Bstep. by K27

"A" SUB GROUP ARTILLERY.

TASK TABLE No. 15.

Reference # - Tracing of Harassing Fire Targets, 1/20,000.
Sheet 62 D., issued with Task Table No. 3.

1. Harassing fire to extreme range, and not closer than 400 yards East of S.O.S Lines.
 Cross country tracks will be omitted but special attention will be paid to metalled roads.
 Bursts of ten (10) rounds per Battery will be fired at the following times.-

<u>Times.</u>	<u>Battery.</u>
8-50, 9-0, 9-5, 9-20, 9-35, 9-50, 10-5 p.m.	26th Battery.
10-15, 10-20, 10-35, 10-40, 10-55, 11-0 & 11-10p.m.	27th Battery.
11-15, 11-25, 11-40, 11-55 p.m, 2-10, 2-15, 2-25a.m.	25th Battery.
2-30, 2-40, 2-55, and 3-15 a.m. 107th Battery.

Batteries are restricted to their Zones as for C.P.

K.D. Watson Lieut.
Adjutant, "A" Sub Group Artillery.

Distribution.-

- Right Group.
- 25th Battery.
- 26th Battery.
- 27th Battery.
- 107th Battery.
- FILE
- WAR DIARY.

T./3/860. 7th Aust. Field Artillery Brigade,
29th July, 1918.

To, Battery Commanders.

Herewith list of hostile batteries active, on which a proportion of the daily harassing fire should be expended occasionally.-

P.12.d.90.75.	Q.7.c.09.11
P.18.b.93.84.	Q.7.c.64.76.
P.18.b.19.42.	Q.7.d.66.47.
P.18.d.37.08.	Q.13.d.38.56
P.18.d.52.23.	Q.13.a.20.12.
P.23.b.58.05.	Q.13.a.93.14.
P.23.d.50.63.	Q.19.c.39.98.
P.23.b.64.60.	
P.24.c.99.41.	
P.24.c.84.10.	
P. 24.b.34.03.	

R. H. Money

Lieutenant,
Orderly Officer, 7th Aust. Field Artillery Bgde.

Date.- 29th July, 1918

"A" SUB GROUP ARTILLERY.TASK TABLE No. 16.

Reference.-Tracing of Harassing Fire Targets, 1/20,000.
Sheet 62 D., issued with Task Table No. 3.

1. HARASSING FIRE. - Harassing fire up to extreme range, and not closer than 400 yards ~~WEST~~ EAST of S.O.S.Lines.
Bursts of ten (10) rounds per Battery will be fired at the following times.

Battery.	Times.
25th Battery.	- 9-10, 9-25, 9-40, 10-10 and 10-30p.m.
26th Battery.	- 10-35, 10-50, 11-15, 11-35 and 11-45p.m.
27th Battery.	- 2-5, 2-25, 3-50, 3-55 and 4-15a.m.

Batteries are resitrected to their Zones as for C.P.

K.D. Watson Lieutenant,
Adjutant, "A" Sub Group Artillery.

Distribution.-

Right Group,
25th Battery,
26th Battery,
27th Battery,
1 07th Battery (for information)
FILE
WAR DIARY.

133

"A" SUB GROUP ARTILLERY.

TASK TABLE No. 17.

File

1. On night 29/30th July, 1918, the Valley running N.E. and S.W. through WARFUSSEE, will be gassed. ZERO HOUR will be 2-30a.m.
2. 107th Battery from forward position, to be occupied on receipt of code word "PUSH-UP" will gas area shown on Tracing "A", attached as follows.--

(a). -Starting at Zero Hour

- BCG - 4 rounds p.h.p.m. - for two (2) minutes.
 - BCG - 3 rounds p.h.p.m. - for Three (3) minutes. *2-30*
rest ten (10) minutes. *2-35*
 - BNC - 2 rounds p.h.p.m. - for thirty (30) minutes. *2-45*
rest ten (10) minutes. *3-15*
 - BNC - 2 rounds p.h.p.m. - for thirty (30) minutes. *3-25*
rest twenty (20) minutes. *3-55*
 - BNC - 2 rounds p.h.p.m. - for twenty (20) minutes. *4-15*
rest twenty (20) minutes. *4-55*
 - BNC - 2 rounds p.h.p.m. - for twenty (20) minutes.
- Total Ammunition 1300 rounds.

- (b) At Zero plus 4 hours 30 minutes, 107th Battery will gas area shown on Tracing B. for four (4) minutes at the rate of 2 rounds p.h.p.m. with B.C.G. Ammunition required for (b) will be drawn from Reserve of 300 rounds at permanent position.

3. 18-Pounder Batteries of 7th Brigade will harass area shown for them on Tracing "B" attached, at the following times and rates

Zero to Zero plus 3 - 4 rounds p.g.p.m.
 Zero plus 55 to Zero plus 58 - 4 rounds p.g.p.m.
 Zero plus 135 to Zero plus 138 - 4 rounds p.g.p.m.
 Zero plus 4 hours 30 mins. to Zero plus 4 hours 34 mins -4 rds p.g. p.m.

Ammunition in usual proportions - 106 Fuze with H.E. if available

4. 107th Battery will withdraw upon completion, providing conditions are favourable, if not, as soon as darkness permits on the following night.
5. Acknowledge by wire.

K.D.W. atton
Lieutenant,
Adjutant, "A" Sub Group Artillery.

Distribution.--

- 25th Battery,
- 26th Battery,
- 27th Battery,
- 107th Battery,
- FILE
- WAR DIARY.

133

TRACING A
GAS BOMBARDMENT

43

106

Sheet 62^d S.E.
Scale 1/20,000

P

29

107 1st Phase

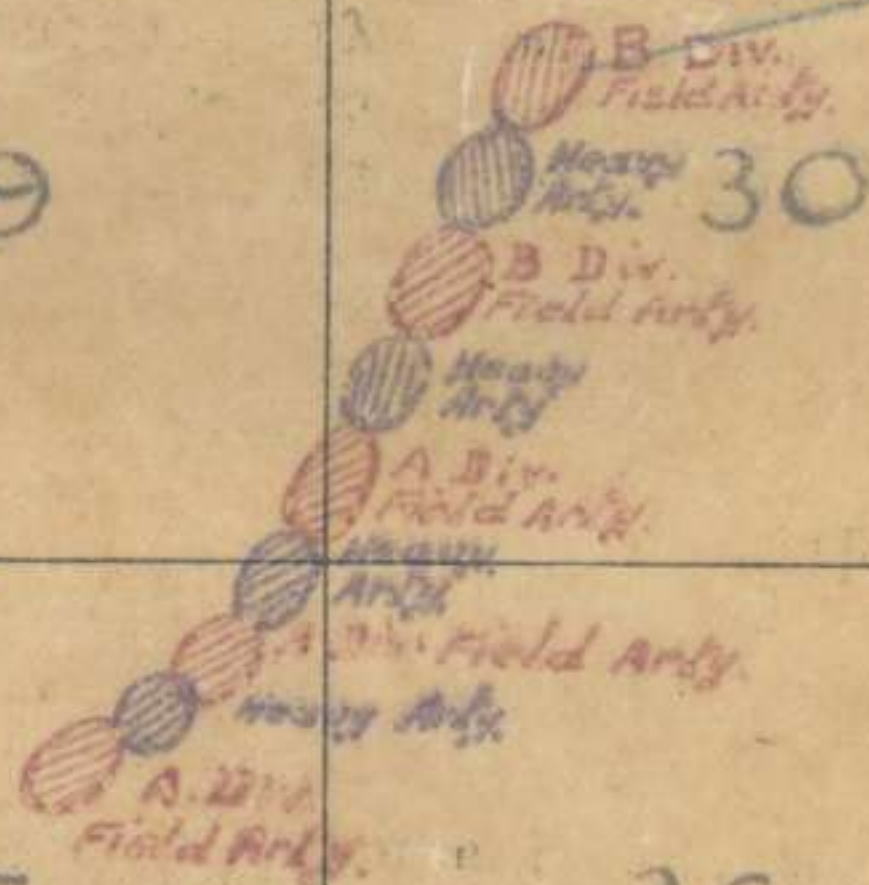

35

36

- TRACING "B" -

- Field Arty Concentration Areas shown Red -

Sheet 62^d S.E.
Scale 1/20,000

P

107

2nd Phase

29



27^d

25

26

35

36



"A" Form
MESSAGES AND SIGNALS.

Army Form C. 2121
(In pads of 100.)

No. of Message.....

Prefix.....Code.....m.	Words.	Charge.	This message is on a/c of:	Recd. at.....m.
Office of Origin and Service Instructions	Sent		Service.
	At.....m.			Date.....
	To.....			From.....
	By.....		(Signature of "Franking Officer.")	By.....

TO { ~~#B~~ + J. Rtyx

Sender's Number. Day of Month. In reply to Number. **AAA**

* 191 29

Key Task Table No 17
PUSH UP

From FUGU
Place
Time 7-5 PM

The above may be forwarded as now corrected. (Z)
Censor. Signature of Addressor or person authorised to telegraph in his name.

* This line should be erased if not required.

9/1/53

THIRD AUSTRALIAN DIVISIONAL ARTILLERY.----- OPERATION ORDER NO. 76 -----

1. The enemy's position in the valley running NE and SW through WARFUSEE-ABANCOURT will be subjected to a gas bombardment and concentration on a date to be notified later.
2. The 4.5" How. Batteries of Right Group, from forward positions to be occupied on receipt of orders from this Headquarters, will carry out the gas bombardment. The two Northern areas, colored RED, marked B Div. Field Arty on Tracing "A" attached hereto, are allotted to the Right Group.
3. ZERO HOUR will be at 2.30 a.m.
4. Details of bombardment by 4.5" Hows are as follows:-

Starting at Zero Hour.

BCG - 4 rds p.g.p.m. for 2 mins	- 96 rds.	
BCG - 3 " " " 3 "	- 108 "	204 rds.
	Rest for 10 minutes.	
BNC - 2 " " p.m. " 30 mins	-----	720 "
	Rest for 10 minutes.	
BNC - 2 rds p.g.p.m. for 30 mins.	-----	720 "
	Rest for 20 mins.	
BNC - 2 rds p.g.p.m. for 20 mins.	-----	480 "
	Rest for 20 mins.	
BNC - 2 rds p.g.p.m. for 20 mins.	-----	480 "
	<u>TOTAL.</u>	<u>2604 "</u>

5. In conjunction with gas bombardment, all 18 pdrs of the Right and Left Groups, whose arcs of fire and range permit, will harass Area 2 shown on Tracing "B" attached, at the following times:-

Zero to Zero plus 3 mins. - 4 rds p.g. p.m.
 Zero plus 55 mins to Zero plus 58 mins. - 4 rds p.g. p.m.
 Zero plus 135 mins to Zero " 138 " - 4 " " " "
 Zero plus 4 hrs 30 ms to Zero plus
 4 hrs 34 mins. - 4 " " " "

Ammunition in usual proportions. - 106 fuze where available.

6. Night of bombardment will be notified by wire from 3rd D.A.H.Q. as follows - "PUSH UP". On receipt of this wire, 4.5" How. Batteries will be immediately advanced into action at forward positions for the purpose of this operation.
7. Hourly wind readings will be sent to Groups from 8 p.m. to 5 a.m., and operation will only take place if wind is between the angle running NE through N and W to S.

P.T.O.

44

133

2.

8. Where conditions permit, Howitzer Batteries will be withdrawn to their normal positions immediately on completion of the bombardment. Should this not be possible, Batteries are to be back in action in original positions immediately after the commencement of the hours of darkness on the night following the date of this operation.
9. Heavy Artillery are also taking part in the bombardment.
10. Orders have already been issued regarding the dumping of ammunition.
11. Watches will be synchronised with Groups on the day on which operation is to take place.
12. Acknowledge by wire.

W. A. Nicholls

Headquarters.
26.7.1918.

Major, R.A.,
B.M., R.A., 3rd Aust. Division.

Distribution:-

	<u>Copy No.</u>		<u>Copy No.</u>
3rd Aust. Div. G.	1	3rd Aust D.T.M.O.	12
Right Art. Grp.	2/4	B.M., R.A.	13
Left " "	5/7	S.O., R.A.	14
Reserve Art. Bde.	8	R.A. Sig. Ofcr.	15
Right Inf. Bde.	9	R.O., R.A.	16
Left Inf. Bde	10	War Diary.	17/19
		FILE. - 20.	

ADDENDUM No. 1 to OPERATION ORDER No. 76.

4.5" Howitzer Batteries of Right Art. Group at Zero plus 4 hours 30 minutes will concentrate for 4 minutes on Area ~~2~~ 2, Tracing "B".
Rate of fire - 2 rds per how per min.
Ammunition - BCG.

W. A. Nicholls

Headquarters.
26.7.1918.

Major, R.A.,
B.M., R.A., 3rd Aust. Division.

<p>27/7/18</p>	<p align="center">-TRACING 'B'-</p> <p align="center">- <u>Field Arty Concentration Areas shown Red</u> -</p> <p align="center">Sheet 62^D SE</p> <p align="center">Scale 1/20000</p>		
<p>Barter's</p>	<p>P</p>	<p>29</p>	<p>2 30 (BDIV)</p>
<p>Issued</p>	<p>35</p>	<p>36</p>	

(SECRET)

ARMY BRIGADE.

R.F.A.

No. 9/293
Date

APPENDIX 44

Copy No. 3

W.D. 11

THIRD AUSTRALIAN DIVISIONAL ARTILLERY.

OPERATION ORDER No. 77.

1. The III Corps is relieving the Australian Corps in the sector North of the SOMME on the nights July 30th/31st and July 31st/August 1st. - command to pass at 10 a.m. on 1st August, 1918.
2. On the night July 30th/31st, the Left Battalion of the 9th Australian Infantry Brigade (North of the SOMME) will be relieved by one Battalion of the 54th Brigade, 18th Division.
3. After relief, the Northern boundary of Australian Corps and "B" Division will run as follows:-
H.22.b.1.7. - H.24.a.9.8. - I.26.b.3.0. - J.25.a.0.0.
thence Eastwards along the Northern Bank of the SOMME Canal.
4. On the night July 31st/August 1st, the 11th Aust. Inf. Brigade will relieve the two Battalions of the 9th Aust. Inf. Brigade ~~on~~ South of the SOMME.
5. Command of the Left Brigade Sector (including that portion held by the 3rd Pioneer Battalion) will pass to the G.O.C., 11th Aust. Inf. Brigade on completion of relief.
Brigade Headquarters will remain as at present, until more suitable accommodation is available.
6. After relief, the 9th Aust. Inf. Brigade will be disposed with two Battalions in the AUBIGNY System and one Battalion in VIEW Sector; and will become Divisional Reserve with Headquarters at I.32.b.
7. Subsequent to the relief by the 11th Aust. Inf. Brigade, the inter-Brigade boundary will be amended to run as follows:-
Junction of roads at O.11.a.6.2. - O.12.c.0.0. - O.12.d.7.0.
O.12.b.6.3. - P.2.a.8.3. P.8.central and P.16.b.4.8.
8. Battalions of American Infantry attached to Brigades will be accommodated as under:-
Battalion of 129th Inf. Regt. in O.16 & 17.
" " 130th " " in IA NEUVILLE.

Moves to these areas will take place as accommodation becomes available, under arrangements to be made by Divisional Headquarters.

9. Artillery arrangements will be as follows:-
At 10 a.m. on the 31st July, Left Artillery Group will cease to be responsible for the Artillery defence of the line North of the River SOMME. At this hour the inter-Group boundary will be amended to run as per inter-Brigade boundary given in paragraph 7 above.
10. Orders regarding Trench Mortars and Anti-Tank Guns will be issued later.
11. ACKNOWLEDGE: *ackd. 4/23/18*

Headquarters.
29.7.1918.

W.D. Nichols
Major, R.A.;
B.M., R.A., 3rd Australian Division.

Distribution on back.

Distribution.Copy No.

"G" Branch, 3rd Aust. Div.	1
Right Art. Group.	2/3
Left Art. Group.	4/5
3rd Army Bde, A.F.A.	6
5th Aust. Div. Art.	7
2nd " " "	8
9th A.I. Bde.	9
10th "	10
11th A.I. Bde.	11
3rd Aust. D.T.M.O.	12
3rd Aust. D.A.C.	13
B.M.; R.A.	14
S.C.; R.A.	15
R.A. Sig. Ofcr.	16
R.O.; R.A.	17
War Diary.	18, 19, 20.
File.	21.

(SECRET)

Copy No. 3

THIRD AUSTRALIAN DIVISIONAL ARTILLERY.

B.M. 5/42.

Reference Operation Order No. 77, dated 29.7.1918.

189th
ARMY BRIGADE,
R.F.A.
No. 91/295/1
Date

Para. 7.

FOR - "P.2.a.8.3."

READ - "P.2.c.8.3."

Right & Left Grps - 3rd Army Bde - D.T.M.O. to acknowledge.

Headquarters.
31.7.1918.

J. Rowe

Major,
for B.M., R.A., 3rd Aust. Division.

Distribution:- To all recipients of O.O. 77.

How

"A" SUB GROUP ARTILLERY.

INSTRUCTION No. 9.

1. The III Corps is relieving the Australian Corps in the Sector North of the SOMME by 10-0a.m. August 1st.
2. After relief the Northern Boundary of the Australian Corps and B. Division will be H.22.b.1.7 - H.24.a.9.8. - I.26.b.3.0. - J.25.a.0.0. thence Eastwards along North bank of the SOMME Canal.
3. At 10-0a.m. 31st July, the Inter-Group and Inter-Infantry Brigade Boundary will be junction of roads O.11.a.6.2 - O.12.c.0.0 - O.12.d.7.0. - O.12.b.6.3. - P.2.a.8.3. - P.8.central - P.16.b.4.8, thence due EAST and the Boundary between "A" Sub Group and 189th Army Brigade on E. & W. line through P.16.d.0.5.
4. At 10-0a.m. 31st July, the "A" Sub Group zone will be from P.17.a.48.90 - P.17.a.36.66 - P.17.a.20.38 - P.16.d.80.80 - P.16.d.50.45 and allotted to 18-Pounder Batteries as follows for S.O.S., C.P. and HARASSING FIRE.-
 26th Battery, P.17.a.48.90 - P.17.a.20.38.
 25th Battery, P.17.a.20.38 - P.16.d.88.90.
 27th Battery, P.16.d.88.90 - P.16.d.50.45.
5. HOW. S.O.S. - 107th Battery - Three (3) Hows on a line 200 yards EAST of the 18-Pounders' S.O.S. Line.
 (a) 1 How. search C.T. through P.17.a. and b.
 (b) 1 How. search road P.18 central - Cross roads Q.7.c.3.5.
 (c) 1 How. search and sweep P.18.c.
 Until the 27th Battery has five (5) Guns in action, the 107th Battery will on dispose three (3) Hows. unallotted to specific tasks and the How. task (c) on a line 200 yards EAST of 27th Battery S.O.S. line.
 107th Battery will kep in touch with 27th Battery in this matter.
6. COUNTER PREPARATION.
 Lane 32 and Northern half of Lane 33 are allotted to Sub Group and will be covered by Batteries within their own S.O.S ~~Lines~~ Zones.
 107th Battery will cover the Sub Group Zone generally for C.P. and Harassing Fire.
7. ACKNOWLEDGE.

K.W. Watson Lieutenant,
 Adjutant, "A" Sub Group Artillery.

Distribution.-

25th Battery,
 26th Battery,
 27th Battery,
 107th Battery,
 FILE
 WAR DIARY.

TASK TABLE NO. 18.

Reference.- Tracing of Harassing Fire Targets, 1/20,000.
Sheet 62 D. issued with Task Table No. 3.

1. GAS BOMBARDMENT.

Time.	Target.	Shell.	Rate.	Battery.
10-3p.m. to) 10-5p.m.)	34.	Howa. BHC 16-Pdrs. AK	G.F. 3 rds p.g.p.m.	107th (1 sec 25th (1 sec 26th.
10-5p.m. to) 10-7p.m.)	34.	BCC.	G.F.	107th.

2. HARASSING FIRE. Harassing fire γ up to extreme range and not closer than 400 yards EAST of S.O.S. Lines. Bursts of Ten (10) rounds per Battery, will be fired at the following times, and will be distributed over the whole Brigade Sector.

Battery.	Times.
107th Battery -	9-0, 9-15, 9-20, and 9-35p.m.
27th Battery -	9-40, 9-45, 9-50, 11-5, 11-10 and 11-15p.m.
25th Battery -	11-25, 11-30, 11-40, 11-45, 11-55 and 12 midnight.
26th Battery -	1-15, 1-20, 1-35, 1-45, 1-50 and 2-0a.m.

In addition to the above Batteries will fire 50 rounds harassing fire between 3-30 and 5-0a.m. and will be taken out of the 100 rounds daily allotment to be fired on unobserved areas.

3. ACKNOWLEDGE.

K. D. Watson Lieutenant,
Adjutant, "A" Sub Group Artillery.

Distribution.-

Right Group,
25th Battery,
26th Battery,
27th Battery,
107th Battery,
FILE
WAR DIARY.

1332

APPENDIX *46*

116

Date. - 31st July, 1918.

"A" SUB GROUP ARTILLERY.
TASK TABLE NO. 19.

Reference.- Tracing of Harassing Fire Targets, 1/20,000.
Sheet 62 D. issued with Task Table No. 3.

1. GAS BOMBARDMENT.

Time.	Target.	Shell.	Rate.	Battery.
11-14 to 11-16p.m.	36	(Hows. BNC (18-Pdrs. AX	GF. 3 rds p.g.p.m.	107th (1 section 25th (1 section 26th 107th.
11-18 to 11-20p.m.	36	BCG	GF	

2. HARASSING FIRE. Harassing fire up to extreme range and not closer than 400 yards EAST OF S.O.S. Lines. Bursts of ten (10) rounds per Battery, will be fired at the following times, and will be distributed over the whole Brigade Sector.

Battery.	Times.
26th Battery -	9-5, 9-10, 9-20, 9-25, 9-35 and 9-40p.m.
107th Battery -	9-40, 9-45, 9-55, and 10-0p.m.
27th Battery -	11-0, 11-5, 11-10, 11-20, 11-30 and 11-35p.m.
25th Battery -	11-25, 11-30, 11-35, 11-40, 11-50 p.m. & 12 midnight.

In addition to the above, Batteries will fire 50 rounds harassing fire between 3-30 and 5-0a.m. and will be taken out of the 100 rounds daily allotment to be fired on unobserved areas.

3. ACKNOWLEDGE.

K.D. Watson Lieutenant,
Adjutant, "A" Sub Group Artillery.

Distribution.-

Right Group,
25th Battery,
26th Battery,
27th Battery,
107th Battery,
FILE
WAR DIARY.

APPENDIX 47

117

133

APPENDIX

~~47~~ 117

133

M. D.

NOTICE

SUR LA

MAISON DE RETRAITE

HIPPOLYTE NOIRET

à FOUILLOY, près CORBIE

(Somme)

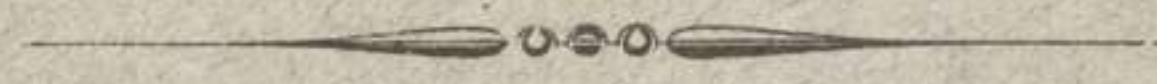

OCCUPIED

BY

7TH. AUST. F. A. BDE. HQ^{RS.}

DURING

JULY 1918

SEDAN

IMPRIMERIE ÉMILE LAROCHE

22, RUE GAMBETTA, 22

—
1900

NOTICE
SUR LA
MAISON DE RETRAITE
HIPPOLYTE NOIRET

à **FOUILLOY**, près **CORBIE**

(Somme)



SEDAN
IMPRIMERIE ÉMILE LAROCHE

22, RUE GAMBETTA, 22

—
1900

MAISON DE RETRAITE HIPPOLYTE NOIRET

à FOUILLOY, près CORBIE (Somme)

La **Maison de Retraite Hippolyte Noiret**, construite de 1894 à 1898, a été inaugurée le 1^{er} octobre 1898.

Edifiée sur un terrain de 3 hectares environ, à 100 mètres du village, elle est complètement isolée et on y jouit d'une vue magnifique de tous les côtés.

Le sous-sol est calcaire (la craie est à 0^m50 de profondeur); l'assise des bâtiments est d'une grande solidité, bien que les fondations aient été relativement peu coûteuses.

Les matériaux employés sont en grande partie la brique grise de Rethel, la brique rouge rebattue pour les encadrements et la pierre dure de Chantilly.

Un sous-sol existe sous tous les bâtiments.

Un aqueduc conduit à la rivière la Somme toutes les eaux pluviales, de la buanderie, les déjections, etc.; c'est le système du tout à l'égout pratiqué pour tout l'ensemble de la maison.

Un chauffage à la vapeur à basse pression, avec radiateurs dans chaque place (Construction Grouvelle), chauffe toute la maison et maintient une température minimum de 15°, même par les plus grands froids.

Un appareil à l'acétylène éclaire toute la maison, le résultat en est très satisfaisant.

La Maison peut recevoir 28 retraités :

6 femmes célibataires ou veuves, en dortoir ;

6 hommes célibataires ou veufs, en dortoir ;

16 hommes et femmes, en 8 ménages, avec chambres séparées pour chaque ménage ;

2 chambres d'infirmierie pour malades de chaque sexe ;

1 chambre pour infirmier ;

1 chambre pour infirmière.

Le personnel se compose de :

- 1 Econome ;
- 3 Sœurs Filles de la Charité de Saint-Vincent-de-Paul ;
- 1 servante cuisinière ;
- 1 homme de service pour le chauffage, l'éclairage et les gros ouvrages.

Les pensionnaires hommes et femmes doivent s'occuper, selon leurs forces et leur état de santé, soit à jardiner, pour les hommes ; soit à tricoter, coudre ou laver, pour les femmes.

Les ménages ne sont donc pas séparés, ils habitent la même chambre ; ils prennent seulement leurs repas séparément aux réfectoires.

Nous prenons les pensionnaires indigents à partir de l'âge de 60 ans. **La gratuité est absolue**, nourriture, habillement et entretien compris. Nous acceptons les pensionnaires indigents quelle que soit leur religion.

La dépense pour achat de terrain, construction et ameublement, s'est élevée à 300,000 francs.

La dépense annuelle s'élève à 20,000 francs, soit environ 600 francs par personne.

La Maison de retraite **Hippolyte Noiret** a été construite par Monsieur **Courty**, architecte à Sedan, auteur de la **Crèche Hippolyte Noiret**, à Rethel.

L'ensemble des bâtiments est d'un gracieux aspect et l'installation ne laisse rien à désirer.



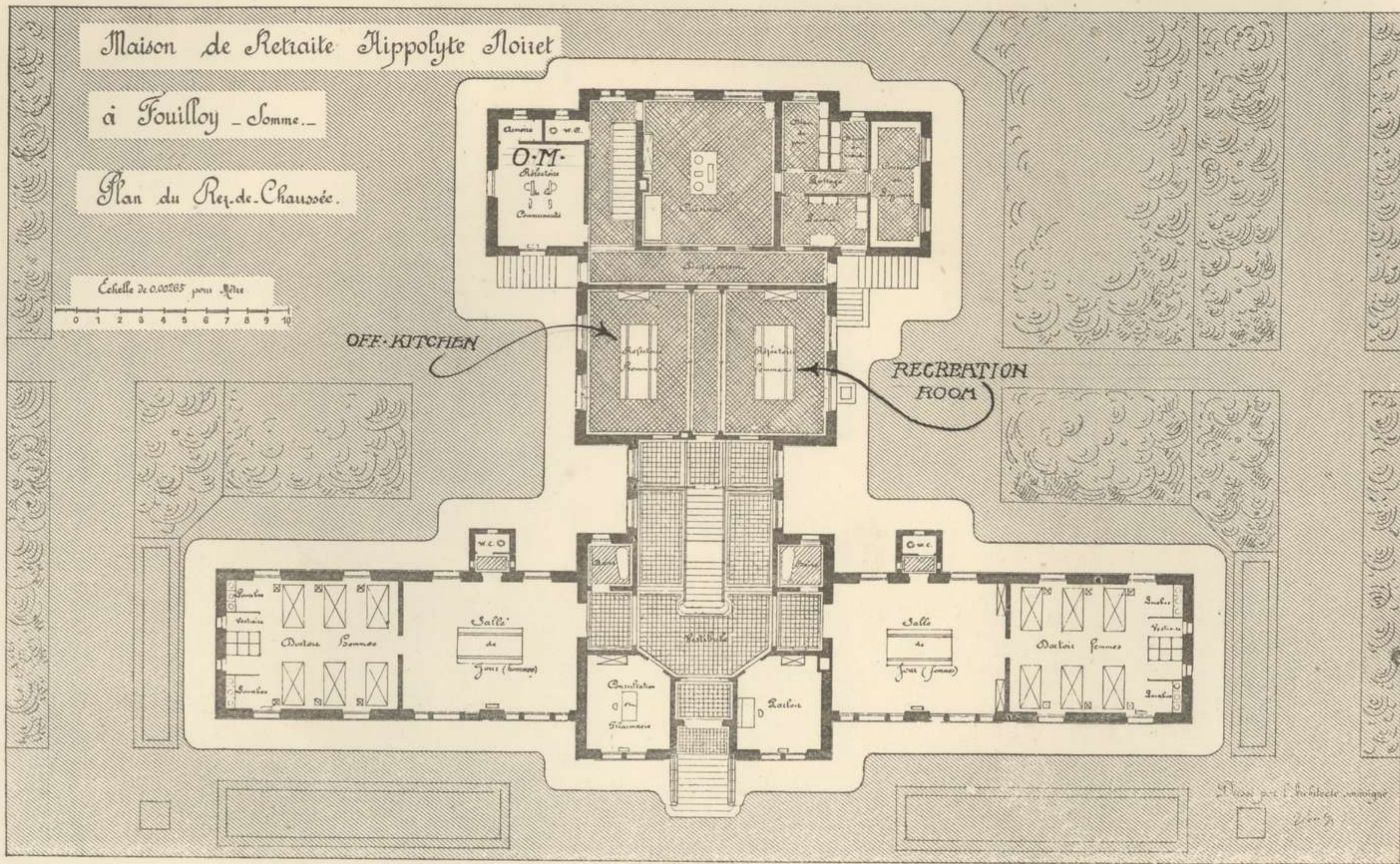

Comm. of 7th A.F.A. 20.7.18.

133

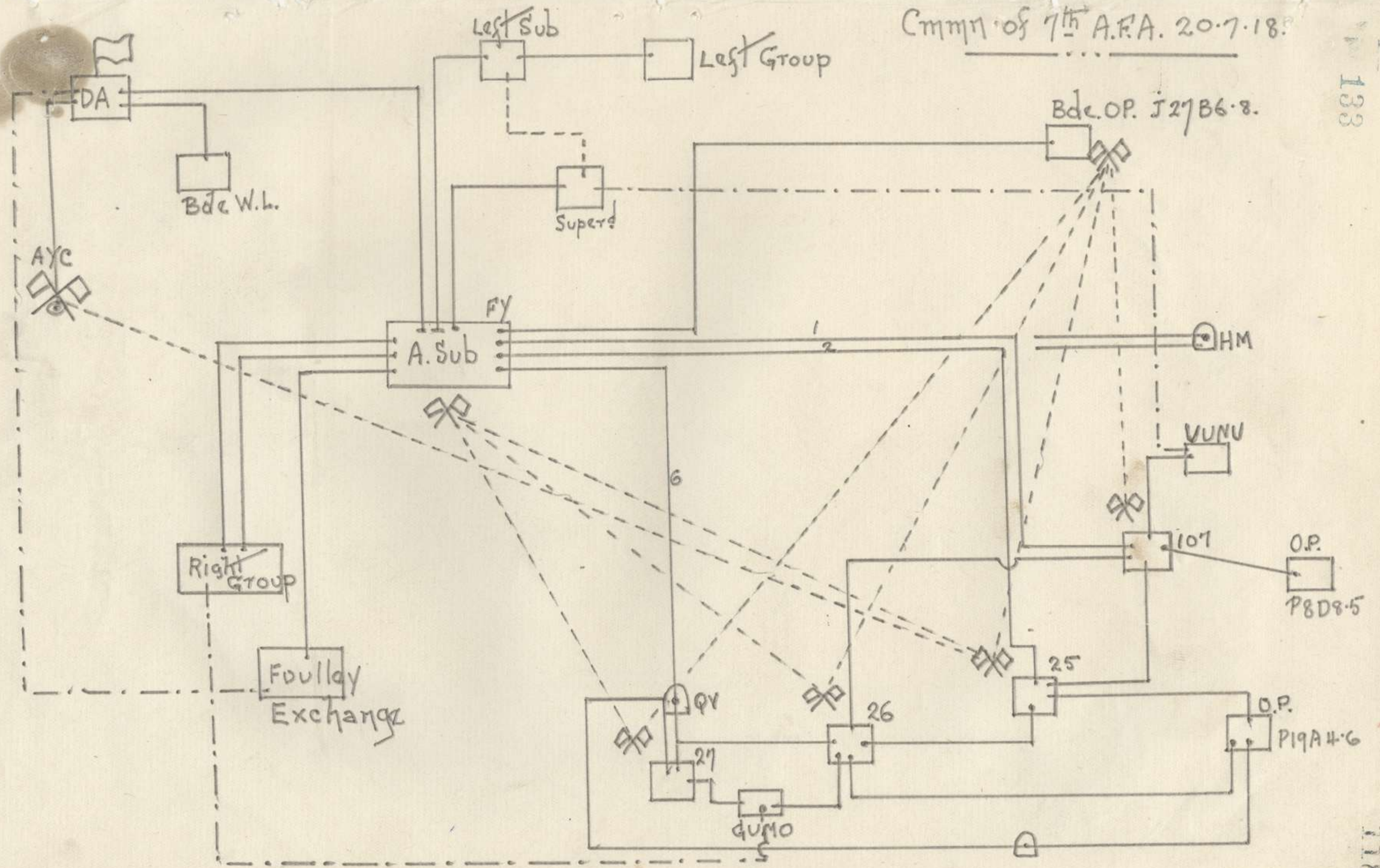

APPENDIX 48

118

"A" SUB-GROUP ARTILLERY.

133

INTELLIGENCE SUMMARY

APPENDIX

49 119

From 2.30 p.m. 16-7-1918 to 12 noon 17-7-1918.

CUR FIRE - 18-pdrs. 4.5" Hows.

- 9.30 p.m. - 36 rounds gas on Area "F".
- 11.18 p.m. 48 rounds gas P.24.a.4.6. to P.24.a.6.7.
- 10.30 p.m. 30 rounds BX on Area "E"
- 2.50 a.m. 105 rounds BX expended on S.O.S. lines
- 3 a.m. 20 Bx on Area "G"
- 3.20 a.m. 120 rounds C.P. Scheme Phase 2.

18-pdrs.

- 9.35 p.m.
to 3.20 a.m. 320 rounds harassing fire on Areas "F" and "E" and
P.11.d.45.35. P.11.d.55.25. P.11.d.65.15. P.11.d.90.00
P.11.d.95.20. P.11.d.95.35. Trench system in P.17.c.
Cross Roads P.24.a.00.50. and Cross Roads in P.17.c.
- 3.50 a.m. 200 rounds C.P. Scheme Zone "A" Phase 2.

HOSTILE FIRE.

Time	Locality shelled	Nature & No of rounds	Direction.
10.30 p.m. 12 m/night to 3 a.m.	0.12.c. 0.17. and 18	20 4.2 H.E. Area Bombardment all calibres H.E. and Gas Yellow cross	Warfusee Bayonvillers

AIRCRAFT. - Very little activity on both sides. - Enemy bombing planes active during the night and several bombs were dropped in the vicinity of Corbie. 2.30 p.m. An enemy balloon was shot down by our aircraft.

MOVEMENT - No movement was observed during the period.

MISCELLANEOUS. - Visibility fair.

K D Watson

Adjutant, "A" Sub-Group Artillery.

Lieutenant,

"A" SUB-GROUP ARTILLERY.

133

INTELLIGENCE SUMMARYFrom 12 noon 17-7-1918 to 10 a.m. 18-7-1918.OUR FIRE. - 18-pdrs.

1.50 p.m. 36 rounds harassing fire in P.11.d.45.35, P.11.d.55.25.
to
3.5 p.m.
5 p.m. 36 rounds " " " P.11.d.65.15, P.11.d.90.00.
3.20 p.m. 15 rounds " " " P.17.d.
5 p.m. 60 rounds in Calibration and Registration.
7 to 9.30 p.m. 280 rounds harassing fire on P.11.d.95.20, P.11.d.95.35 Eastern half of Areas "B" and "E", Bank in P.17.c. X Roads P.29.e., Trench System P.17.c., Suspected H.Q. at P.17.b.30.20.
9.45 p.m. 68 rounds as per O.O. No.20. - S.O.S. Lines in Northern third of Lane 34
10.35 p.m. 270 rounds harassing fire on, Areas "B" and "E", P.17.d. to P.18.d., Road in P.29.c. and d., P.23.a.
3.20 a.m.

4.5" Hows.

3.30 p.m. 54 BX in Registration of Zero Point in P.17.b.
9.20 p.m. 24 Bx in harassing fire on P.23.a.
11.10 p.m. 12 rounds BX harassing fire on P.18.d.
11.45 p.m. 36 rounds BX harassing fire on P.23.d.3.3.
2.20 a.m. 12 BX harassing fire P.17.d.

HOSTILE FIRE.

Time	Locality shelled	No of rounds & nature	Direction.
2.30 p.m.	P.18 and 12	40 77mm	
4.15 p.m.	Corbie	10 5.9	123 deg T.B. from I.35.b.78.65.
8 p.m.	P.18 & 12	10 77mm	
11.30 p.m.	O.12.c.	25 4.2 H.E. & gas Blue cross	
10 a.m. to 4 a.m.	O.18.a.	Intermittent shelling 77mm and 10.5 c.m.	La Motte en Santerre
10.49 a.m.	P.10.b. & d	40 77mm	Warfusee

ENEMY ATTITUDE? - Normal. During afternoon of 17th instant Hostile Artillery opened on our forward area with short bursts of fire at irregular intervals.

MOVEMENT. - No movement observed, with exception of a few men who were seen moving between Windy Trees and main Road near Warfusee. 8pm
AIRCRAFT. -

Our planes were active over enemy forward areas throughout the day, using their machine guns on his trenches. No hostile planes were observed over our lines.

MISCELLANEOUS. - Visibility good.

Lieutenant,
Orderly Officer, "A" Sub-Group Artillery.

INTELLIGENCE SUMMARY.

From 10 a.m. 18-7-1918 to 10 a.m. 19-7-1918.

OUR FIRE 4.5" Hows.

9 p.m. 20 BX expended on N.F. Call P.24.b.3.5. - Good shoot and mostly O.K's reported.
 10 p.m. 48 BX on Target No 34 P.17.central
 12 m/night 48 BX " " " "
 1.15 a.m. 48 BX on Target No. 49 P.23.d.10.30.
 2 a.m. 56 BX on Target No 39 P.23.a.30.70.
 3 a.m. 600 BNC on special Operation in Q.14.b. and Q.8.d

18-pdrs.

5.30 to 7.30 p.m. 200 rounds harassing fire on the following:-
 Roads P.29.c., P.11.d.45.35., P.11.d.55.25.,
 3.20 a.m. P.11.d.65.15., Q.7.c.3.3. P.11.d.95.20.
 9.20 to 11.54 360 rounds harassing fire on the following:-
 P.17.d., P.18.c., Road in P.18.c., P.18.d.30.30.
 P.12.d.50.25., P.18.b.7.9., P.18.b.
 Q.7.c.3.3.

HOSTILE FIRE.

<u>Time</u>	<u>Locaility shelled</u>	<u>No of rounds nature</u>	<u>Direction.</u>
2.15 to 2.30 p.m.	0.36.b. & 0.30.d	100 all cal.	Warfusee
2.35 p.m.	Roads in P.19.a. & P.29.b.	12 77mm	Tailloux Wood
3 p.m.	0.30.b. & d.	3 77mm	Warfusee
4.45 p.m.	0.30.b.	10 5.9	do
5.20 p.m.	0.30.d.	18 5.9	do
8.25 p.m.	0.16.d.	80 5.9 4.2	do
9.40 to 10.15	0.16.a, b, & d	160 5.9	T.B. 114 deg from N.19.a.40.70.
11.30 p.m.	0.12.c. & d.	12 5.9 4.2	unobserved.
7.25 a.m.	0.17.c.	10 5.9	114 deg from N.19.a.40.40.
7.50	0.18.d.	20 5.9	do
8.15 a.m.	P.19.c.	10 4.2	105 deg from N.19.a.40.40.
9.5 a.m.	0.24.a.	25 5.9	Warfusee
9.50 a.m.	Back areas	40 5.9	T.B. 113 deg from N.19.a.40.70.

ENEMY ATTITUDE - Enemy artillery showed increased activity especially on back areas.

AIRCRAFT. - There was little activity on both sides. At 8.40 a.m. 2 enemy planes crossed our lines but were driven off by A.A. fire. Balloons were observed at T.B's of 150, 139, from N.19.a.40.70.

MOVEMENT. - 11.45 a.m. One man seen walking in P.29.c. and at 12.35 p.m. 2 men were observed proceeding from P.22.c. to Warfusee.

MISCELLANEOUS - Visibility fair.

K. D. Watson

Lieutenant,
Adjutant, "A" Sub-Group Artillery.

"A" SUB GROUP INTELLIGENCEFrom 10 am 19-7-18. to 10 a.m. 20-7-18.OUR FIRE - 18-pounders.

During the day 200 rounds were fired on areas invisible from O.Ps., namely - Road in P.18.c. P.17.d. P.12.d.3.3. P.12.d. 50.25. and P.18.b. 79. Between 9.48 p.m. and 10.15 p.m. 90 rounds fired during synchronised shoots on areas 37.39.& 40.

At intervals from 9.30 to 3.35 a.m. general harassing fire was maintained on Enemy approaches and forward system. 450 rounds being expended.

At 9.45 a.m. and 1 p.m. 40 rounds dispersing movement around Windy Trees, P.29.b.00.50.

4.5" Hows.

6.45 p.m. 50 BX on Enemy M.Gs. along Embankment between P.17.d. 42.18. and P.17/.c.20.85.

8.35 p.m. 25 BX N.F. call on a Battery at P.28.c.84.10.

From 9.48 to 10.15 p.m. 130 BNC on areas 37.39.& 40. as per T.T. No.4.

HOSTILE FIRE.

Time	Locality Shelled	No of rounds	Calibre	Direction.
------	------------------	--------------	---------	------------

During the day Enemy Artillery was exceptionally quiet, and during night fire showed slight decrease from previous period. Only 2 instances of gas shelling reported. The main shoots were:-

3 p.m.	P.20.c.	10	4.2	TB 104 from P.19.a.40.70.
4.40 p.m.	P.19.c.& P.25.a.	20	4.2	do
5.30 p.m.	CORBIE	30	5.9	TB 113 from P.19.a.40.70.
7.30 p.m.	O.11.a.	50	4.2 gas	Cerisy. (blue X)
7.50 p.m.	HAMEL	20	77s	Reginald Wood.
8.30 p.m.	FL& Supports in P.10.	100	77 & 4.2	P.24.& 30.
4.15 a.m.	J.28.c.& d.	20	77(blue X)	Q.9.
6.20 a.m.	VAIRE WOOD	20	4.2	TB 92 from P.19/a.4.7.
8.10 a.m.	O.17.a.	20	4.2	TB 78 from P.19.a.4.7.
8.45 a.m.	P.20.a.	80	4.2	TB 93 from ditto
10 a.m.	O.18.	30	77s	LA MOTTE

ENEMY ATTITUDE.

Quiet but alert.

AIRCRAFT.

2.10 p.m. one E.A. crossed our lines about O.27. but was driven off by A.A. fire.

2.30 p.m. two of our 'planes brought down a Hostile Balloon in flames. They were heavily engaged by E. A.A. fire but returned safely.

9 a.m. one E.A. was driven down and crashed about Q.13. and at 9.15 a.m. an Enemy Balloon at TB.168 from J.27.b.6.3. was brought down in flames by one of our Scouts.

Balloons were up at TB 108 & 148 from J.27.b.6.3. and 65, 84, 142, from P.19.a.40.70.

OBSERVATION OF ENEMY

At 1.5 p.m. two men were seen about P.29.a.5.6. and when fired on they disappeared into a Dugout.

8.40 p.m. horse transport seen moving about Q.23.d. towards MORCOURT and at 5 a.m. two G.S. Wagons proceeded along main road in Q.26.c. towards LA MOTTE.

6.45 a.m. a party of the Enemy, about 20 men was engaged when moving towards TAILLAUX WOOD by 18-pounders and dispersed.

9.45 a.m. movement around Windy Trees, in P.29.b.0.5. was engaged and casualties caused.

TRAINS.

4.30 p.m. considerable traffic movement was observed around stationery train R.25.c.

5.15 a.m. a train was seen in R.26.c. moving EAST and at 6.5 a.m. a light train was observed at P.24.d. proceeding N.E.

VISIBILITY - GOOD.

R. H. Honey

O.O., 7A" SUB GROUP ARTILLERY.

Lieutenant,

From 10 a.m. 20-7-18. to 10 a.m. 21-7-18.

OUR FIRE. - 18 pounders.

4 p.m. 184 rounds fired on movement in P.29.c.& d. The Party was dispersed and disappeared into the trenches.
4.20 p.m. 60 on individual movement in P.29.b 0.5. 3 casualties were caused. During the day harassing fire was maintained on unseen areas and roads with special attention to the valley in Q.7.c. & Q.13.a. also the approaches to WARFUSSEE. 275 rounds expended.

11.2 to 11.30 p.m. 96 rounds fired on areas 34,40, and 41. in conjunction with gas shoots by 4.5" Hows.

9.25 to 3.35 a.m. 280 rounds general harassing fire on the following targets:-

Valley in Q.13. Road Junctions P.29.b.00.34. and P.23.c.83.46. X Roads P.29.d.00.70. and P.12.d.30.30., P.12.d.50.30. and Q.7.c.3.3..

4.5" Hows;

5.45 p.m. to

7.15 p.m. 72 BX on tracks in P.23.a.

9.25 p.m. 20 BX on hostile Battery at P.18.d.5.2.

10.40 p.m. 20 BX on Battery at P.24.d.1.6.

11.2. to

11.30 p.m. 108 rounds B.N.C. and 24 BCBR on areas 40.41 and 34.ife. P.18.c., P.24.c., and P.17 central.

1.35 a.m. 20 BX on Battery at P.24.b.40.05.

HOSTILE FIRE.

Again light and scattered and confined to harassing shoots. No barrage or concentration reported. A neutralisation was effected at 11 p.m. on a section of 8" Hows at approx. O.12.b.3.6. About 30 rounds 5.9 HE being fired from the direction of P.30. Light harassing fire on the following areas during the night:-

J.22.b.& d. J.27.a.& b. P.10.c.& d. and J.34.c. (mixture of blue X gas and H.E.) The principal shoots were:-

Time	Locality shelled	No of rounds	Calibre	Direction.
4 p.m.	O.18.c.	50	77	Cerisy.
5.15 p.m.	P.25.a.	66	77	100 TB from P.19.a.95.60.
7.15 p.m.	P.18.d.	30	5.9	P.24.
10.30 p.m.	FOUILLOY	30	5.9	Warfussee.
11.55 p.m.	J.27.a.	10	77 phos.	Malain Wood.
9 a.m.	P.13.c.	40	4.2 shrap	TB 99 P.19.a.4.7.

ENEMY ATTITUDE. Quiet, and less alert.

AIRCRAFT. E.A. inactive during the period. Only one balloon reported for a short time during morning at TB 148 from J.27.b.6.3. Our planes very active over enemy lines.

OBSERVATION OF THE ENEMY. 6 to 7 a.m. small parties of the enemy seen to leave Northern corner of AQUAIRE WOOD proceeding in an easterly direction. 7.15 a.m. 2 G.S. Wagons loaded with hay left WARFUSSEE along main road for GAILLY.

8.30 a.m. 3 men carrying dixies seen at approx. P.29.a.5.5. to disappear into a dugout.

5.45 p.m. horse drawn transport seen on road in P.25.a.& c.

49

330

125

TRAINS.

6.10 p.m. a train observed on light railway about R.25.c.
6.50 a.m. a train was seen leaving HAZEL WOOD going in a
Northerly direction.

VISIBILITY INDIFFERENT OWING TO GROUND HAZE.

R. S. Money

Lieutenant,

O.O., "A" Sub Group Artillery.

10.30 p.m. 100 rounds 1.5.0. and 24 BORN on axes 40.41 and 34.110.
11.15 p.m. 100 rounds 1.5.0. and 24 BORN on axes 40.41 and 34.110.
12.30 p.m. 100 rounds 1.5.0. and 24 BORN on axes 40.41 and 34.110.
1.15 a.m. 100 rounds 1.5.0. and 24 BORN on axes 40.41 and 34.110.

Again light and scattered and confined to harassing
shots. No barrage or concentration reported. A heavy
invasion was effected at 11.15 on a section of 8" Hows
at range 1.5.0. about 30 rounds 1.5.0. being
fired from the direction of 1.5.0. Light harassing fire
on the following axes during the night:-
1.5.0. and 24 BORN on axes 40.41 and 34.110.

Time	Locality shelled	No of rounds	Calibre	Director
4 p.m.	1.5.0.	50	IV	Corley.
5.15 p.m.	1.5.0.	50	IV	100 BORN
7.15 p.m.	1.5.0.	50	IV	1.15.0.0.0.
9.30 p.m.	1.5.0.	50	IV	1.5.0.
11.30 p.m.	1.5.0.	50	IV	1.5.0. 1.5.0. 1.5.0.
1.15 a.m.	1.5.0.	50	IV	1.5.0. 1.5.0. 1.5.0.

Very little activity, quiet, and less alert.
E.A. inactive during the period. Only one balloon reported
for a short time during morning of 11.15 from 1.5.0.0.0.
Our planes very active over enemy lines.
Observation of the night 6 to 7 a.m. small parties of the enemy seem
to leave northern corner of HAZEL WOOD proceeding in an
easterly direction. 1.5.0. 1.5.0. 1.5.0. 1.5.0. 1.5.0. 1.5.0. 1.5.0.
left HAZEL WOOD along road for 1.5.0.
1.5.0. a.m. 5 was carrying 600 lbs seen at
approx. 1.5.0.0. to disappear into a bog.
1.15 p.m. horse drawn transport seen on
road in 1.5.0.0.0.

From 10 a.m. 21-7-18 to 10 a.m. 22-7-18.

OUR FIRE - 18 Pounders.

35 rounds at intervals during afternoon on individual movements in P.23.c. and P.29.a. This was dispersed on each occasion.

During the day dead ground opposite Group Sector, especially Q.7c.3.3. P.18.b.7.3. P.12.c.50.25 Cross Roads P. 23.d. 20.05. and approaches to WARFUSSEE were harrassed, 200 rounds being expended.

1-12 a.m. to 2-15 a.m. 72 rounds on areas 36, 34, 42, in conjunction with 4.5 How Gas shoot.
390. rounds general harrassing fire on enemy trenches tracks, dumps, and centres of activity during the night.
4-45a.m. to 5-49 a.m. Short bursts of special harrassing fire were directed along the roads and tracks in P.23.b. P.24.a &c. and P.24.d. 90 rounds being fired.
9-15 a.m. 30 rounds on enemy trenches at P. 23.a.

4.5 Hows.

8-Op.m. 75 BX on Machine Gun Nest at P.17.a.95.05. very satisfactory shotting.
11-Op.m. 30 rds B.X. on hostile battery in P.18.d.
12 midnight. An active M.G. about P.17. central was effectively silenced at request from Infantry.
1-12a.m. to 2-15 a.m. 75 BNC and 50 BX on special Gas targets, 36, 34 and 42.
4-45a.m. to 5-49a.m. 20 rds. BX special harrassing fire on roads and tracks in P. 23 b. P. 24 a. & c.

HOSTILE FIRE

A further decrease was noticeable on the Group Sector during the period. At night light harrassing fire was maintained on HAMEL, WELCOME WOOD, P.3, b & d. P. 4 a & c. O. 12 c. & d. and O. 18, whilst our trenches and forward areas received the usual attention.

The principal shoots were as follows:

Time	Locality shelled.	No of rds.	Calibre	Direction
4-45p.m.	J.22	100	5.9	Malard wd
4-50p.m.	J.27.b.	25	5.9	do
6-15 p.m.	P.19.c	20	77 mm	TB h.108 from P.19.a.4.7
9-30p.m.	HAMEL.	40	77 mm	TB 135 from P.27.b.65.35
11-35p.m.	P.4.d.	50	77 mm	do
12 midnight	WELLCOME WOOD.	10	5.9	TB 130 from P.27.b.65.35
1-45 a.m. to 2-30 a.m.	Intermittent shelling of HAMEL	50	77 mm & 5.9	DERISSY
6-30a.m.	P.16.a.	30	5.9	HAMILTON WD
No instances of Gas Shelling were reported.				

ENEMY ATTITUDE. Quiet, no change.

AIRCRAFT.

At 5-Op.m. One of our planes crossed the enemy lines and was heavily engaged by A.A., M.Gs., firing from approximately P.17.a. 95.00. These were observed from one of our O.Ps. at P.16.b.1.6. and engaged by 4.5 Hows. very successfully.

AIRCRAFT (Contd.) 8-30p.m. an enemy plane was flying low over our trenches in P.17.

11-30p.m. Bombs were dropped by hostile planes along the Valley between HAMELET and CORBIE.

HOSTILE BATTERIES ACTIVE.

9-30p.m. A flash from 77 mm Battery was observed at TB 135, from J. 27 b.65.3x5 firing into HAMEL. A section of 8" Hows. from 68th Brigade, R.G.A. were informed and the Battery was silenced immediately.

OBSERVATION OF THE ENEMY. 8-10p.m. enemy transport was seen along the main WARFUSSEE Road in Q.26.

6-45a.m. An enemy wagon loaded with hay was observed about the Cross Road in Q. 26.c.

During the morning individual movements were noticed along the road in P. 26.c., P. 22.b., 9570 and at P. 27 a. also around Windy Trees at P.29.

MISCELLANEOUS.

At 7-30p.m. a pigeon was observed flying Eastwards from the suspected Company H.Q. at P.17. central, and later during the evening a black dog was observed coming towards this point from P.18.

VISIBILITY GOOD.

R. A. Money

Lieutenant.

O.O., "A" Sub Group Artillery.

Time	Locality	No. of shells	Remarks
10-15 p.m.	Q.26	100	Enemy transport
11-15 p.m.	P.17	20	Hostile plane
12-15 p.m.	P.18	20	Black dog
1-15 p.m.	P.26.c.	20	Enemy wagon
2-15 p.m.	P.22.b.	20	Enemy movements
3-15 p.m.	P.27 a.	20	Enemy movements
4-15 p.m.	P.29	20	Enemy movements
5-15 p.m.	P.17	20	Enemy movements
6-15 p.m.	P.18	20	Enemy movements
7-15 p.m.	P.17	20	Enemy movements
8-15 p.m.	P.17	20	Enemy movements
9-15 p.m.	P.17	20	Enemy movements
10-15 p.m.	P.17	20	Enemy movements
11-15 p.m.	P.17	20	Enemy movements
12-15 p.m.	P.17	20	Enemy movements

"A" SUB GROUP ARTILLERY.

INTELLIGENCE SUMMARY.

From 10-0a.m. 22-7-18 to 10-0a.m. 23-7-18.

OUR FIRE. - 18-Pounders.

During the Afternoon 215 rounds on registration of S.O.S. line, and 150 rounds on harassing unobserved areas including Red Junction P. 23.c. and P.29.a. Cross Roads P.23.d. 20.05., Q.7.c.3.3. and P.12.c.50.25.

Between 10-20p.m. and 2-40a.m., 72 rounds on areas 42 and 43, in conjunction with How. Gas shoots.

10-35p.m. & Areas shoots were put down on P.24.b., c and d., at request from Infantry, 108 rounds being expended.

11- 0p.m. & 280 rounds were fired on P. 16.b. & d. and P. 17.a & c. 3-0a.m. in support of patrols.

200 rounds general harassing fire during the night on enemy Roads, Approaches, Trenches and centres of activity

4.5 Hows.

65 rounds during afternoon on M.G. position P.17.a.95.00. (several direct hits).

Re-entrant in P.24.a. and road in P. 18.b.

7-40p.m. & 40 rounds in response to N.F. call on Battery at

8-20p.m. P.24.c.99.41. Plane reported M. O.K.

10-40p.m. to) 72 rounds BCBR on special Gas targets in areas 42 and 43 2-40a.m.) and P. 24.b. 20.25, P.24.d.32.61. and P.24.c.80.65.

During the night 30 rounds BX general harassing fire on C.P. Zones, with special attention to hostile batteries in P. 18.d.

HOSTILE FIRE.

Hostile artillery activity showed a considerable increase during the night, but remained quiet by day. From 9-30p.m. to 10-30p.m. at our front line system near HAMEL was subjected to heavy harassing fire from 5.9s approximately 300 rounds falling. Light harassing fire at intervals on J. 29.d. (including a few rounds Blue Cross Gas) P.13, P.19, O.24, and WELLCOME WOOD. Between midnight and 3-0a.m. a light concentration of Green and Blue Cross Gas was put down on O.10, 11, 12, and O.18. General direction Valley in Q.13 and P.30.

The principal shoots were as follows:-

Time.	Locality shelled.	No. of rds.	Calibre.	Direction.
5-20p.m.	O.36 a. & b.	70	5.9	TB 132 from P.19a. 40.70.
7-30p.m.	J.29.d.	10	5.9	HAMILTON WOOD.
9-30p.m.	P.19.d.	10	77mm	From TB 93 from P.19.a.40.70.
9-45p.m.	F.L. near HAMEL.	40	5.9	TB 155 from J.27. b.65.25.
10-40p.m.	P.21.a.	10	77mm	CERISSY.
2-25a.m.	P.20b.	10	4.2.	Time H.E. -----
6-25a.m.	O.18.c.	50	77mm	TB 100 from P.19. a.45.75.
Midnight to 5 a.m.	O.12.c.	60	77mm (Blue X)	Valley in Q.7 and Q.13.

ENEMY ATTITUDE. More Active, especially during night. Made several attempts to reconnoitre our back areas, with his reconnaissance flights.

"A" SUB GROUP ARTILLERY.
INTELLIGENCE SUMMARY.

From 10-0a.m. 23-7-18 to 10-0a.m. 24-7-18.

OUR FIRE. 18-Pounders.

2-55p.m. to P.12.c.30.30, P.12.c.50.30. 20 rounds harassing fire.
4-20 p.m.
5-0p.m. 28 rounds expended on finding corrector.
6-5p.m. to 20 rounds harassing fire on Q.7Xc. 3.3. and P. 18.b.7.9.
7-5p.m.
6-55p.m. 24 rounds harassing fire on road in P. 17.d.
7-10p.m. 48 rounds expended on trench in P.17.d.
8-15p.m. 10 rounds harassing fire on P.12.c.30.30.
9-15p.m. to 60 rounds on the following:- Suspected H.Q. P.17.d.35.20
11-10p.m. Suspected H.q. P.17.a.80.80. Road in P. 23.a., Trenches
P. 23.a. and Road in P. 23.c.
10-0p.m. to 220 rounds harassing fire on the following:-P.17.c.40.00 to
3-30a.m. P.17.c.21.70., P.17.c.21.70. to P.17.a.40.50., areas
P.17.c.,). 23.c., P. 23.a.
3-20a.m. to 20 rounds harassing fire on P. 12.c.30.30 and P. 12.c.50.30.
3-40 a.m.

4.5 Hows.

6-10p.m. 36 BX on tracks in P. 23.d.
7-25p.m. 36 Bx " " " "
9-38p.m. 36)BX in P. 24.a.
36)
10-0p.m. to 96 BX on area P.17.c.10.10.,).17.c.25.15., P. 23.a.41.60.
10-18p.m. P. 23.a.20.58.
11-20p.m. 10 BX on Battery at P.24.d.0.6.
11-40p.m. 10 BX on Battery at P.18.b.35.20.
11-55p.m. 10 BX harassing fire on centre of movement at P. 23.a.0.9.
3-30a.m. 24 BX on area P.23.a.

HOSTILE FIRE.

Time.	Locality shelled.	No of rds.	Calibre.	Direction
11-10a.m.	P.21.a.	20	77mm	TB 110 from P.19.a.4.7
11-50a.m.	B VAIRE WOOD.	15	4.2	TB 92 " do
1- 0 p.m.	P.25.c.	20	77mm	TB 134 " do
2-25p.m.	O.30.	180	4.2	CERRISSY.CERRISSY.
2-30p.m.	P.20.d.	20	4.2	TB 120 from P.19.a.4.7
3-0 p.m.	P.21a. & c.	50	4.2	TB 120 " do.
3-35p.m.	P.19.d.	15	4.2	WARFUSSEE.
4-55p.m.	P.19.a.	10	77mm	CERRISSY.
6-10p.m.	P.19.a.	15	77mm	TB 109 from P.19.a.4.7
8-30p.m.	CORBIE.	30	5.9	HAMILTON WOOD.
No gas shelling reported.				

ENEMY ATTITUDE. Less Active, especially during night.

AIRCRAFT. Below normal. At 7-55p.m. E.A. seen to rise from ground in P.28.b. and flew in South Westerly direction for the line.

OBSERVATION OF THE ENEMY. At 6-15 p.m. a G.S. wagon observed on road in Q. 14.a. travelling in a South Westerly direction.
9-15p.m. Considerable amount of smoke seen rising from a house in ~~MEMME~~ HEMMEL. 11-20p.m. Small explosion seen to occur at T.B. 158 deg. from (U.2.b.98-10) apparently Small Arms Dump. 7-30a.m. 5 enemy seen in P.29.a. disappearing into trench.

VISIBILITY. poor - clear at intervals.

H. Watson

Lieut.

Adjutant, 7th Aust. Field Artillery Brigade.

"C" Form.

MESSAGES AND SIGNALS.

Army Form C. 2123
(In books of 100.)

No. of Message.....

Prefix.....	Code.....	Words..... e s d.	Received. From <i>HVMD</i>	Sent, or sent out. At.....m.	Office Stamp. <i>FUG J 24 VII. 18</i>
Charges to Collect			By <i>ROA</i>	To.....	<i>SIGNALS</i>
Service Instructions. <i>AUZE</i>			By.....	By.....	
Handed in at.....			Office..... m	Received <i>11/47/18</i>	

TO

FUGU

*Sender's Number

40208

Day of Month

24th

In reply to Number

AAA

French front aaa
Total prisoners captured
yesterday north of
Montdidier 52 officers
including 4 Btr Commanders
1800 ORG aaa 4 77 MM
guns 3 O MW and over
1000 MG also taken aaa
In fighting on Marne
front British troops
took over 1000 prisoners
and 110 MG and recovered
17 75 MM gun

FROM

RT Group

TIME & PLACE

*This line should be erased if not required

From 10-0a.m. 24-7-18 to 10-0a.m. 25-7-18.

OUR FIRE. 18-Pounders.

1-0p.m. 58 rounds on movement in P.29.a. and b. with excellent results.
100 rounds during the afternoon on calibration and registration on Windy Trees
9-50p.m to 10-2p.m. 85 Rounds in conjunction with special gas shoots by 4.5 How.
During the day 140 rounds on unobserved areas, opposite the Group front and 575 rounds general harassing fire at night, on enemy dumps, trenches centres of activity roads and approaches, special attention being paid to the latter on account of suspected enemy relief.
The following targets were also engaged.-
Headquarters at P.17.a.85.00, New Work P.12.c.20.10. and Roads in Q.13.a and P. 23.a.
4.5 HOWS.

9-50p.m. to 10-2 p.m. 125 rounds BCBR on Gas Target No. 39.
11-45p.m to 3- 5 a.m. 80 rounds BX general harassing fire on zones B., C., and D. and movement along roads in P. 23.a. and c.

HOSTILE FIRE. Generally light and scattered during day; at night usual harassing fire on forward areas. No gas shelling reported.

Time.	Locality shelled.	No. of rounds.	Calibre.	Direction.
3-30 to 3-45p.m.	Trenches in P.25 and P.31.	100	4.2 & 5.9	MARCELCAVE.
4-45p.m.	O.17.b. central.	10	21 cm. H.E	HAMILTON WOOD.
4-50p.m.	O.12.d and O.18.b.	25	4.2 H.E.	HAZEL WOOD.
5- 0p.m.	P.25.c. and d.	30	4.2	TB 132 from P.19.a.4.7.
8-50p.m.	P.16.d.	10	77mm)T.B145 J.27.b.65.
10-25 p.m.	P.15.b and d.	50	77mm)25.
10-55 p.m.	P.4.c. and d.	40	77mm	TB 135 from J.27.b.65.2x5
12 midnight to 3-10a.m.	J.33.a. J.34.c.)	100	4.2 77mm (TB 150 from J.27.b.65.25
10- 0a.m.	O.10.d.	25	4.2	CERISSY

HOSTILE BATTERIES.

10-20p.m. A Flash was observed from a 77mm Battery at TB. 135 deg. from J.27.b.65.25.

ENEMY ATTITUDE. No change.

AIRCRAFT.

E.A. were less active during the period, only one attempt being made to penetrate our lines near VILLERS - BRET. Our planes were active and at 6-22a.m. brought down an enemy balloon in flames at T.B. 153 from J.27.b.65.25. Balloons were up during the morning at TB 39 deg. from P.19.a.40.70 and TB.113, 153 from J.27.b. 65.25.

OBSERVATION OF THE ENEMY. During the evening and early morning, individual movement was reported and fired on in P.23.d. and P.29.a.; also P.17.d. and Q.19.d.

5-45p.m. Five G.S. wagons loaded with hay were seen on roads in Q.25 and P.30.d. proceeding East.

7-10p.m. Considerable enemy movement around Q.26 d.80.35. which appears to be a dump.

8-Op.m. A party of five huns seen to enter a small dugout about P.17.a.5.5.

8-45p.m. Horse transport, several horsemen and three men on foot were observed on main road in Q.29.d. This road seems to be the medium for considerable traffic.

MISCELLANEOUS. During a shoot at 1-Op.m. by one of our 18-Pdr. Batteries a new record was established from the cross roads in P.23.d. to the edge of TAILLOUX WOOD about P.22.a.4.6. - two men on foot, with full equipment and rifles covered this distance in 2 min. 35 seconds - during the last 100 yards, one of the party, was seen to fall and had to be carried in later by a party of stretcher bearers.

VISIBILITY Fair with poor intervals. Good on 25th instant.

R. Money

Lieutenant,

O.O., 7th Aust. Field Artillery Brigade.

TIME	LOCATION	DESCRIPTION	REMARKS
5-45p.m.	Q.25 and P.30.d.	Five G.S. wagons loaded with hay	proceeding East
7-10p.m.	Q.26 d.80.35	Enemy movement	appears to be a dump
8-Op.m.	P.17.a.5.5	Party of five huns	entered a small dugout
8-45p.m.	Q.29.d.	Horse transport, several horsemen and three men on foot	observed on main road

ENEMY ATTITUDE. No change.

REMARKS. A flash was observed from a T.M. battery at 10.15p.m. from P.27.d.80.35.

REMARKS. No change.

REMARKS. No change.

"A" SUB GROUP ARTILLERY.
INTELLIGENCE SUMMARY.

From 10-0a.m. 25-7-18. to 10-0a.m. 26-7-18.

OUR FIRE. 18-Pounders.

12-20p.m. 15 rounds harassing fire on P.12.c.3.3.
 12-45 to 1-30p.m. 50 rounds harassing fire on P.12.c.3.3., P.12.c.5.3;
 C.7.c.3.2
 4-5p.m. 50 rounds registration zero point at P.29.a.90.35.
 4-45p.m. 55 rounds harassing fire P.17. central
 5-35p.m. 20 rounds on enemy's movement at .25.d.6.5.
 12-20p.m. to 9-10 p.m. to 4-5a.m. 600 rounds harassing fire on the following:-
 P.18.b.7.9., P.12.d.9.5., P.18.c., P.12.c.3.3., P.12c.5.3.
 C.7.c.3.2., P.12.d.95.10., P.17.d.8.7., P.17.c.2.7.
 P.17. central, P.23.a. and d., road in W. 18.c., road
 P.23.c.83.46. & P.17.c.2.7.

4.5 Hows

2-0p.m. 27 rounds BX on M.G. at P.17.c.90.90.
 5-30p.m. 60 rounds BX on M.G. emplacement at P.17.b.4.4.
 9-10p.m. 12 rounds BX on Trench System at P.23.d.
 9-25p.m. 12 rounds BX on road in P.18.b.
 9-35p.m. 9 rounds BX on road in P.18. central.
 9-50p.m. 9 rounds BX on Battery in C.13.c.
 10-0p.m. 30 rounds BNC area 34.
 10-7p.m. 18 rounds BX area 39.
 10-14p.m. 24 rounds BX area 49.
 1152 p.m. 18 rounds BX area 39.
 5-10a.m. to 6-5a.m. 50 rounds BX on P.17.c.30.10 at request of Infantry.

HOSTILE FIRE.

Times.	Locality shelled.	No. of rounds.	Calibre.	Direction.
11-10a.m.	WELLSOME WOOD.	100	4.2 & 5.9	WARFUSSEE.
1-0 p.m.	HAMEL.	30	4.2	do
2-0 p.m.	P.25.a. and c.	40	5.9	MARCELCAVE.
2-5 p.m.	P.L. in P.26 c and d	40	5.9	do
11-30p.m.	C.18.a.	80	77mm & 4.2 (H.E & GAS) Blue X)	HAMEL WOOD.
12-30a.m.	O. 17.	600	All Calibre incldg 77 Blue X)	General.
7-15a.m.	P.L. in P.16.b.	8	77mm	CERISSY.
7-40a.m.	P.L. in P.16.c and P. 15 d.	18	77mm	EB 135 frm J.27.b6.2
8- 0a.m.	P.7.a.	20	4.2	WARFUSSEE.
8-30a.m.	O.12.c.	10	4.2	MARCELCAVE.
8-35a.m.	P.12.c.	12	4.2	WARFUSSEE

ENEMY ATTITUDE. Enemy artillery a little more active during the day, no definite registrations observed.

AIRCRAFT. Less active than usual. One of our planes brought down enemy balloon in the vicinity of BAYONVILLERS and returned safely to our lines.

OBSERVATION OF THE ENEMY. During the evening and early morning individual movement was observed and fired on in C.25.d., P.29. and C.30.b.
 3-45p.m. Two enemy observed coming out of trench in C.25.d.5.6 and walked over to trench in P.19.d.9.0 and disappeared
 6-25p.m. Six enemy seen walking from Windy Trees to Crucifix Corner.
 9-10p.m. Nine men observed waling around Crucifix Corner.

"A" SUB GROUP ARTILLERY.
INTELLIGENCE SUMMARY.

From 10-0a.m. 26-7-18. to 10-0a.m. 27-7-18.

OUR FIRE. 18-Pounders.

At intervals during the day 300 rounds expended on individual movement in Q.25., trenches in P.23.a. and P. 29.a., on harassing areas invisible from G.Ps. and on registrations.

1-0a.m. to 159-a.m. 48 rounds were fired in conjunction with Gas Shoots by 4.5 Hows. During the night 340 rounds general harassing fire on the following targets.-
road in P. 24 a. and c. track through P. 27.d., M.Gs. and P. 17c.2.7. and P. 18.d.8.7. and P.12.c.13.3 P.18.b.7.9. and Q.7.c.3.2.

4.5 Hows.

2-0p.m. to 4-0p.m. 80 rounds BX on movement around P. 17.a. central and P. 17.d.5.5., very successful shoots.

10-25p.m. to 11-35p.m. 50 rounds BX on M.Gs., P.17.c.8.8. and P. 17.c.6.6., also active Battery at P.18.d.6.2.

1-0a.m. to 1-59 a.m. 88 BNC, 20, BCG and 36 BX on special Gas Targets, 34 and 36.

HOSTILE FIRE. Enemy artillery showed a marked increase during the evening, though only fire of a harassing nature was recorded. Areas receiving particular attention from 4.2 and 5.9 were, O.12.c., O.17.b. and d. O.18.c., FOUILLOY, CORBIE, and HAMELET.

Times	Locality shelled.	No. of rounds.	Calibre.	Direction.
4-0p.m. to 5-0p.m.	CORBIE	(Approx 20	5.9 T.HE.	WARFUSSEE
5-5p.m.	P.16.b.2.7.	25	77mm	CERISSY.
5-15p.m.	SAILLY le SEC	50	77mm & 4.2	MORLANCOURT.
7-30p.m.	VAIRE WOOD.	10	77mm	TB 148 J.27.b.65.25
9-45p.m.	Trenches near BOUNEN COURT.	50	4.2	MALARD WOOD.
11-0p.m. to 11-30p.m.	CORBIE AND O.11.a	150	4.2. H.E. & Gas Blue X	WARFUSSEE.
12-10a.m. to 1-30a.m.	WELLCOME WOOD.	60	21cm.	BAYONVILLERS.
3-15a.m.	Trenches in P.10 & P.16.	50	4.2. H.E.	HAZEL WOOD.
3-15a.m. to 3-45a.m.	WELLCOME WOOD.	40	21c.m.	BAYONVILLERS.

HOSTILE BATTERIES. At 6-0p.m. a 5.9. H.V. gun from T.S.B.98 deg from P.19.a.4.7. fired about 10 rounds on the road near the Cemetery at O.18.a.3.4. no damage was done.

ENEMY ATTITUDE. Normal, slightly more active on back areas.

AIRCRAFT. 7-45 to 8-30p.m. our reconnaissance planes very active using their machine guns on enemy trenches in the neighbourhood of ACCROUCHE WOOD.

8-15p.m. 4 E.A. crossed our lines over VAIRE WOOD but were driven back by our A.A. fire. Balloons were up during the early morning at TBs. 55, 123, 150, and 173 from P.18.a.4.7.

OBSERVATION OF THE ENEMY. 7-20a.m. enemy transport seen on track in P.23.d. proceeding in direction of ACCROUCHE WOOD. This was engaged and turned back towards WARFUSSEE.

OBSERVATION OF THE ENEMY (Contd)

7-45a.m. Wagon was seen on the track in P.23.d. proceeding South.

8-15a.m. Movement was noticed around suspected O.P. at 0.9.a.3.5. approx. During the morning the usual individual movement around Windy Trees and Crucifix Corner was engaged on several occasions with success.

VISIBILITY. Poor with fair intervals.

R. H. Money

Lieutenant,
O.O., 7th Aust. Field Artillery Brigade.

Hostile fire was observed during the evening. The only fire of a harassing nature was recorded. The following positions were observed on 18.10.1918.

FOULLOX, GEBEL, and HANDEL.

Times of hostile fire.

Hostile fire was observed at 11.00 a.m. and 11.15 a.m.

Time	Position	Remarks
4-00 a.m.	to GEBEL	
4-00 a.m.		
5-00 a.m.	1.10.1.1.7.	
5-15 a.m.	SALTY to HQ	
7-30 a.m.	VAIN WOOD.	
8-45 a.m.	Trench near HORNBY COURT.	
11-00 a.m.	to GEBEL and O.I.I.	
11-30 a.m.		
12-15 a.m.	to HANDEL WOOD.	
1-30 a.m.		
2-15 a.m.	Trench in P.10 & P.11.	
3-15 a.m.	to HANDEL WOOD.	
3-45 a.m.		

Hostile Batteries. At 6-00 a.m. a 5.9. H.V. gun from T.2.5.98 dug from P.10.1.1.7. Fired about 10 rounds on the road near the Cemetery at 0.10.1.1.7. no damage was done.

Enemy attitude. Normal, slightly more active on back area.

At 8-30 p.m. our reconnaissance plane very active when their machine guns on enemy trenches in the neighbourhood of HORNBY COURT.

At 11 a.m. crossed our lines over VAIN WOOD but were driven back by our A.A. fire. Balloons were up during the early morning at T.2.5.1.1.7, 150, and 175 from P.10.1.1.7.

Observation of the enemy. At 7-30 a.m. enemy transport seen on track in P.23.d. proceeding in direction of GORCHON WOOD. This was engaged and turned back towards HANDEL.

"A" SUB GROUP ARTILLERY.
INTELLIGENCE SUMMARY.

from 6-0p.m. 27-7-18 to 5-a.m. 28-7-18.

COPY.

Wire to E 3rd D. A. H. Q.
M./43. 28-7-18.

- A. Our 18 Pdrs. from 7p.m to 8p.m. fired 200 rounds on movement and unobserved areas aaa During night 260 rounds general harassing fire confined to metal roads in P. 17 and 18. P. 23 and 24. Hows. At 6p.m. 30 BX on M.G. at P. 17.c.80.80 - several explosions of S.A.A. caused and at night 90 rounds harassing fire on roads Q.7.c.20.40. aaa.
- B. Hostile artillery again very active especially between the rivers aaa South of SOMME confined to harassing fire. At 8p.m. 80 rounds 4.2 H.E. on SAILLY-Le-SEC At 11p.m. our F.L. and supports near BOUZENCOURT received 100 rounds 77mm and 4.2 5a.m. 40 rounds 77 Gas on HAMEL. Areas harassed by 4.2 and 4.9 were CORBIE, WELLCOME WOOD, HAMELET, P.l.a., O.18.c and d., O.17.b. and d. O.12.c. at intervals.
- F. Aircraft. 12-30a.m Gothas crossed our line bombing back areas near HEILLY. Movement. Early evening the usual individual movement around TAILLOUX WOOD and WINDY TREES. Flashes from a hostile 77 mm gun were seen firing from approx. J.36.d. central in SAILLY-LAURETTE. Visibility. Poor.

(From) 7th A. F. A. Brigade.

APPENDIX

49 133

6-0a.m. 28-7-18 to 6-0p.m. 28-7-18.

OUR FIRE. 18 Pounders.
3-0p.m. 50 rounds registration on Windy Trees at P.29.a.95.39.

9-0a.m. 4.5 Hows.
78 rounds BX on movement in P.17.c.20.00 and P.17.d.7.0
Very effective shoot.

11-30a.m. 50 rounds BX on trenches in TAILLOUX WOOD, P.23.a. and
sunken road P.17.a.

2-15p.m. 40 rounds on re-entrant P.17.c.20.80.
2-45p.m. 10 rounds on new work near suspected Headquarters,
in P.18.a. 0.7 two direct hits obtained.

HOSTILE FIRE. Enemy artillery was very quiet during the day, fire
being of a light harassing nature and well scattered
over our forward areas.

Times.	Locality shelled.	No. of rounds.	Calibre.	Direction.
8-0a.m.	P.15.	50	77mm	ACCROUCHE WOOD.
9-25a.m.	J.16.a. and c.	15	4.2	HAZEL WOOD.
10-0a.m.	P.19.d.	20	4.2	T.B.95, from 19.a.4.7.
10-15a.m.	P.19.b.	20	4.2	TB 115, from do.
10-25a.m.	HAMEL WOOD.	5	4.2 T.HE.	TB 90 from do.
10-30a.m.	O.17.	15	4.2	TB 109 from do.
11-45a.m.	P.19.c. P.20 & P.26	50	77mm	CERISSY.
11-50a.m.	Trenches in P.10.b. and P.16.k.a.	15	4.2 T.HE	WARFUSSEE.
2-15p.m.	VAIRE WOOD.	15	4.2	WARFUSSEE.
4-15p.m.	O.29.	40	4.2	MARCELCAVE.
4-30p.m.	O.10.d.	5	5.9	TB 95 from P.19.a.4.7.

ENEMY ATTITUDE. Quiet, no change to report.

AIRCRAFT. 8-15a.m., one E.A. patrolled our front line in the
vicinity of ACCROUCHE WOOD.
8-0a.m. to 9-15 a.m. Considerable aerial activity. Five enemy observation
planes crossed our lines over VAIRE WOOD, but were
driven back in the direction of VILLERS BRET. by A.A.
fire. Balloons were up during the morning at TBs.
65, 90, and 128 from P.19.a.4.7.

OBSERVATION OF THE ENEMY. 10-30a.m. two men seen for a few minutes
with Field Glasses in a trench about P.18.a. central.

VISIBILITY. Indifferent with fair intervals.

Red Money
Lieutenant,
O.O., 7th Aust. Field Artillery Brigade.

"A" SUB GROUP ARTILLERY.INTELLIGENCE SUMMARY.From 6-0a.m. 29-7-18 to 6-0p.m. 29-7-18.
-----OUR FIRE. 18 Pounders.

12 noon 25 rounds on dispersing movement at P.29.a.90.30.
 3-0p.m. 30 rounds on a party of five men at P.18.a.70.30.
 Result of shoot very effective.
 During the day 55 rounds harassing fire on unobserved areas including the following targets.-
 P.12.c.3.3., P.12.c.5.3., Q.7.c.3.2., and Q.7.d.00.43.

4.5 Hows.

1-0p.m. 35 rounds BX on registration of dugout at P.18.c.10.65
 The same place was again engaged at 3-15p.m., 25 rounds being fired, of which several were direct hits.

HOSTILE FIRE. Enemy's artillery was extremely quiet throughout the day, especially on forward areas. An H.V. 5.9 gun was active between 1-30 and 4-0p.m. on O.10.a. probably meant for the road.- about 8 rounds fired.

Time.	Locality shelled.	No. of rounds.	Calibre.	Direction.
6-30a.m.	WAMEL	10	4.2	WARFUSSEE.
8-30a.m.	O.30.	10	5.9	TB 111 from 19.a.84.7.
9-30a.m.	J.35 and 36	40	4.2	T.B.95 from J.27.b.65.25
10-25a.m.	Road in O.18.	20	77mm	TB 120 from P.19.a.4.7.
11-0a.m.	J.32.	10	4.2 T.HE	TB90 frm do
12-40p.m.	VAIRE WOOD.	20	4.2	TB90 from do.
2-30p.m.	Track in P.19.c.&d.	45	77mm	WARFUSSEE.
3-30p.m.	J.27.b.	10	4.2	HAMILTON WOOD.

ENEMY ATTITUDE. Quiet. Showed no inclination to retaliate after our attack.

AIRCRAFT. E.A. were exceptionally inactive during the day, none being reported over our lines. Our planes showed great activity and patrolled the enemy's lines on numerous occasions.
 12-30p.m. to 2-0p.m. 10 Bombs were dropped by our reconnaissance planes on TAILLOUX WOOD.

OBSERVATION OF THE ENEMY. 12 noon, two men seen to enter small length of trench about P.18.c.10.65. This spot was suspected to be a dugout and was registered by our 4.5 Hows. at 1-0p.m. When engaged later at 3-15p.m. two men were seen to crawl away from the dugout during the shoot.

12-50p.m. 3 G.S. Wagons observed loading hay about Q.25.b. These moved to the main road when full and disappeared, in an Easterly direction.

VISIBILITY. Indifferent, owing to heavy ground haze.

R. H. Honey Lieut.
 O.O., 7th Aust. Field Artillery Brigade.

COPY.

Wire to 3rd Aust. D. A. H. Q.

H.224 29-7-18.

- A. Our 18- Pounders during the night fired 210 rounds general harassing fire on metalled road in P.17 & 18 and P.23 and 24. Our Hows. fired 40 rounds harassing fire during the night on roads in Q.7.c.
At 12-30 a.m. our 18-Pounderx Batteries fired 700 rounds in conjunction with operations on "CW Div. front.
- B. Hostile Batteries showed a marked decrease for the period, only scattered harassing fire being reported. The following are the chief shoots.

11-15p.m.	15,	5.9. in O. 18.b.
1-0a.m.	30,	4.2 in O.18.b.
4-45a.m.	10,	4.2. in O.18.a.
5-0a.m.	25,	4.2. H.E. and Gas (Blue X) on O.12.c.
- C. Nil.
- D. Below normal for the period.
- F. Aircraft. No enemy aircraft activity. Our planes active during early morning. At 7-20.p.m. one of our planes dropped Green light over approx. J.18.
Movement. During the evening, some movement observed around TAILLOUX WOOD.
Visibility. Poor.

APPENDIX 49 141

133

10

7th AUST. FIELD ARTILLERY BRIGADE.

STRENGTH JULY, 1918.

	<u>Off.</u>	<u>O.R's.</u>
JULY, 1st.	33	807.
JULY, 31st.	37	844.

7th AUST. FIELD ARTILLERY BRIGADE.

CASUALTIES FOR MONTH OF JULY, 1918.

	<u>Off.</u>	<u>O.R's.</u>
Killed In action.	--	--
Wounded.	-	3
Wounder (R.O.D.)	-	1

7th AUST FIELD ARTILLERY BRIGADE.

SCHOOLS ATTENDED DURING JULY, 1918.

	<u>Off.</u>	<u>O.R's.</u>
4th Army Signal School.	-	2
3rd Div. Fitter's Course.	-	8
4th Army Artillery School.	2	4
4th Army Camouflage School.	-	1
4th Army Veterinary School.	-	1

"A" SUB GROUP ARTILLERY.INTELLIGENCE SUMMARY.From 6-0a.m. 30-7-18. to 6-0p.m. 30-7-18.
-----OUR FIRE. 18-Pounders.

3-45p.m. Movement about P.29. central, 30 rounds expended, result
 5-0p.m. very satisfactory.
 4-30p.m. 40 rounds registration, and during the day 50 rounds on
 dead ground opposite Group front, especially the following
 targets.- P.12.c.5.3., P.18.b.7.9 and the road between
 Q.7.c. 3.2 and Q.7.d.35.55.

4.5 Hows.

12-30p.m. 10 rounds on RATE Wood, dispersing a party of enemy at
 work.
 3-0p.m. 24 rounds on registration.
 3-15p.m. 40 rounds on suspected Headquarters at P.18.a.central.
 Many direct hits were obtained and a large quantity of
 timber thrown into the air.

HOSTILE FIRE. Enemy artillery was very quiet during the morning
 but showed some activity, between 2p.m. and 6p.m.
 especially on back areas, around FUILLOY. On two
 occasions a section of 8 in.Hows. situated about O.10.b.3.7
 were neutralised with a few rounds 4.2. H.E. from the
 direction of WARFUSSE. Other fire was scattered and of
 a light harassing nature, on HAMEL, SAILLY-LE-SEC, WELLCOME
 WOOD, J. 27.a., O.18. and O.11 and 12.

Time.	Locality shelled.	No. of rounds.	Calibre.	Direction.
8-30a.m.	P.25.c.	50.	4.2	(TB 128 frm P.19.a.45. (75.
9-0a.m.	VAIRE WOOD.	10	4.2 H.E.	do do
10-5a.m.	O.24.d.	30	77mm	do do
11-45a.m.	P.19.c.	25	5.9	TB 106 frm P.19.a.4.7
2-0p.m.	O.18.c.	50	4.2	HAMEL WOOD.
2-25p.m.	O.24.a. and c.	60	77 & 4.2	Q.13.central.
3-5p.m.	O.24.c.	15	4.2	WARFUSSE.
3-30p.m.	O.17.	10	5.9	MARCELCAVE.
4-0p.m. to	FUILLOY.	30	5.9	TB95 frm P.19.a.45.75
5-0p.m.				TB105 X do
5-15p.m.	P.19.a. and O.24.b&d	20	5.9	TB105 " P.19.a.4.7.

ENEMY ATTITUDE. Quiet during morning, retaliated on our roads, back
 areas and Heavy Battery positions, slightly, during afternoon.

AIRCRAFT. 7-30a.m. a flight of our scout machines flew over enemy lines
 in the vicinity of ACCROUCHE WOOD.

8-30a.m. Our R.E.8's, bombed enemy front line in the vicinity of
 WARFUSSE, and again near TAILLOUX WOOD at 12-40p.m.
 H.A. inactive.

OBSERVATION OF THE ENEMY. Individual movement during the afternoon on
 the road in P.24.a. and c. and P.29.c. was engaged on several
 occasions.

1-30p.m. A considerable amount of individual movement was noticed
 around the Quarry in K.31.central. This continued during
 the afternoon and is apparently a Headquarters, as much loose
 earth and camouflage (probably over dugouts) can be seen at
 this spot.

VISIBILITY. Low, owing to heavy haze.

Lieut. Orderly Officer, 7th A.F.A. Brigade.

COPY.

Wire to 3rd Aust. D. A. H. Q.

M/48. 30-7-18.

Intelligence, 6p.m. - 6 a.m. aaa

- MA.** 18 Pounders expended 50 rounds on registration of S.O.S. lines at 6-15p.m.
 From 6-30p.m. to 9-0p.m, 150 rounds on unseen areas, including P.12.c.5.3., Q.7.c.3.2., Q.7.d.0.0., P.17.6.d. and suspected M.Gs. in P. 17.a. and c.
 During the night 350 rounds general harassing fire on enemy ~~positions~~ approaches, communication trenches and trenches.
 From 2-30 - 7-0a.m. (in progress) 665 rounds on special areas in P.30. Valley in conjunction with gas shoot aaa
 4.5 Hows., 1300 rounds gas between 2-30 and 7-0a.m. (in progress) on special targets in P.30.a.6.4. and vicinity.
- B.** Enemy artillery only showed normal activity and no heavy retaliation shoots took place during our bombardment. Fire was light and scattered, the following were harassed at intervals, SAILLY-LE-SEC, HAMEL, WELLCOME WOOD (with 4.2s.) J.27.a. and b. J. 35.c., P.9 a. and b. whilst at 8-40p.m. light area shoot of 77mm and 4.2s was placed on VAIRE WOOD for 10 minutes.
 Roads and battery areas in O.18.a. and b and O.17.a. also received light attention from 77mm.
- C.** Nil.
- D.** Slight increase of usual harassing fire, otherwise no change.
- RF.** 10-10p.m. Large dump exploded at T.B.101 from O.18.b.7.5.
 Very foggy during night and early morning. 6-0a.m. whole front quiet.

7-50 A.M. FUGU.

INTELLIGENCE SUMMARY.From 6-0a.m. 31-7-18 to 6-0p.m. 31-7-18.
-----OUR FIRE. - 18-Pounders.

12-20-p.m. 55 rounds expended on harassing fire in P.18.a & b.
to 4-30p.m. and Q.13.a. and b. and Q. 14 b.
4-45p.m. 42 rounds expended on calibration.

4.5 Hows.

12 noon 32 rounds BX expended on Headquarters at P.18.a central.
2-30p.m. 18 rounds BX expended on calibration.
4-0p.m. 30 BX expended on M.Gs. at P.17.d. 1.9.

HOSTILE FIRE. Enemy artillery was rather more active during the period. The following are the main shoots.

Time.	Locality shelled.	No. of rounds.	Calibre.	Direction.
7-30a.m.	O.11.a.	24	4.2	TB 120 frm P.19.a.4.7
9-0a.m.	VAIRE WOOD.	30	5.9	TB 125 do
9-10a.m.	P.26.c.	30	77mm	WARFUSEE.
9-40a.m.	P.20.b.	55	77mm	TB 108 fm O 19a.5.5.
10-30a.m.	Trenches in P.26.b.	20	77 & 4.2	WARFUSEE.
12-45p.m.	Trenches in P.19.c.	30	5.9	HAZEL WOOD.
1-25p.m.	Trenches in P.21.a.	14	5.9	TB 128 fm P.19.a.4.7
1-45p.m.	VAIRE WOOD.	20	77mm	do do
4-25p.m.	O.18.b.	20	4.2	MARCELCAVE.
4-35p.m.	O.24.d. & O.30.c.	10	5.9	TB 105 fm P 19.a.4.7
4-45p.m.	107th Bty position (O.12.c.)	10	5.9	WARFUSEE.

ENEMY ATTITUDE. Increased ^{ARTILLERY} activity during the period.

AIRCRAFT. No activity to report.

OBSERVATION OF THE ENEMY. 2-0p.m. Smoke seen rising from dugout at P.18.b.10.25.

VISIBILITY. Low - improved slightly during the afternoon for intervals.

R. Money Lieutenant,
O.O., 7th Aust. Field Artillery Brigade.

C O P Y.

Wire to 3rd D. A. H. Q.

H .234. 31-7-18.

- A. From 9-40 to 2-0a.m., 18-Pounders fired 280 rounds harassing fire on enemy approaches, C. Ts. and trenches. At 4-0a.m., 30 rounds fired into suspected Headquarters at P.17. central. 4.5 Hows from 9 to 9-35p.m. fired 40 rounds general harassing fire into P.12 c., P.18.b. and c. and P. 23 a. 10-3p.m. to 10-7p.m. 96 BNC on area 34 as per instructions.
- B. Enemy artillery activity rather above normal. The chief shoots were. directed on P.16.a., J.23, WELLCOME WOOD, J.28, 29 and 34, Saily-le-Sec. From 10-30 to 10-45 p.m. approx. 200 rounds 77 Yellow Cross and H.E. fell in O.18. Light fire was scattered over whole sector.
- C. Nil.
- D. Rather more active.
- f. 6-15p.m. a party of 7 huns were seen in P.23, moving along road with stretchers and red cross flag. Rather misty during night and early morning. 6-0a.m., Front quiet.

'8-0a.m.

FUGU.

"A" SUB-GROUP ARTILLERY.

GAS BOMBARDMENT - night 16th/17th July, 1918.

133

Unit	Time	Date	Wind Dir.	m.p.h.	Weather conditions	No of rounds No of guns Nature	Target	Method of fire
107th	9.35 p.m.	16-4-18	N W by N	5	dry	6 guns 30 BNC & BCBR	Area "F"	G.F. 3 mins
"	11.18 p.m.	16-4-18	W.S.W.	2	"	6 guns 48 BNC & BCBR	P.24.a.4.6. to P.24.a.6.7.	G.F. 4 mins.

Adjutant "A" Sub-Group Artillery.

K. D. Watson Lieutenant.

APPENDIX

49

133

"A" SUB-GROUP ARTILLERY.

133

GAS BOMBARDMENT - Night 18th/19th July.

Battery	Date	time	Wind Dir. m.p.h.	Weather Conditions	No of guns No of rounds Nature	Target	Method of fire
107th	19--19-- 19-7-18	3 a.m.	Calm	clear	6 guns 600 BNC	G.14.b. as per O.O. No.73	Different rates for 1 hr 28 mins

K.D. Watson

Adjutant, "A" Sub-Group Artillery.

Lieutenant,

APPENDIX

49

148

"A" SUB GROUP ARTILLERY.

Gas Bombardment for period ending noon 20/7 /18.

153

Bty	Date	Time	Weather Conditions	Wind Dir.	H.R.H.	Nature, No of Guns No. of rounds	Target	Method.
107th Bty	19-7-18.	9.48 pm.	Dry	W.N.W.	2	6 guns, 36 BHC	No. 37	GF.
do	do	9.56 pm.	Dry	W.N.W.	2	6 guns, 36 BHC	No. 39	GF.
do	do	10-2 pm.	Dry	W.N.W.	2	6 guns, 36 BHC	No. 40.	GF.
do	do	10.15 pm.	Dry.	W.N.W.	2.	6 guns, 24 BHC	Nos 37.39.40.	GF.

Orderly Officer, *H. D. Watson* Lieutenant,
"A" sub Group Artillery.

APPENDIX

49
149

"A" SUB GROUP ARTILLERY.

GAS BOMBARDMENT

For period ending noon 21-7-18.

Bty	Time	Date	Wind Dir.	M.P.H.	Weather conditions	No of guns. No of rounds Nature	Target	Method
107th	11.2. pm	20th	S.W.	3	Dry	6 guns, 36 BHC	No. 40	G.F.
do	11.9 pm.	do	S.W.	3	Dry	6 guns, 36 BHC	No. 41	G.F.
do	11.20 p.m.	do	S.W.	3	Dry	6 guns, 36 BHC	No. 34	G.F.
do	11.30 p.m.	do	S.W.	3	Dry.	6 guns, 24 BCBR	No. 34	G.F.

R. A. Horey
Adjutant, "A" Sub Artillery.

Lieutenant,

APPENDIX

49

150

Gas Bombardment

107th How Bty

7th FA B

21/7/18

Date and Time	Wind M.P.H. Dir	Weather Conditions	No of gns	Nature of gas	No of rds	Nature and Location of target	Method of Fire
11.2pm	3 S.W.	Dry	6	BNC	36	Target Table No 5 Target 40 P18C	G.F. 2min
11.9pm	3 S.W.	Dry	6	BNC	36	Target Table No 5 Target 40 P24C	G.F. 2min
11.20	3 S.W.		6	BNC	36	Target Table No 5 Target 34 P17 central	G.F. 2min
11.30	3 S.W.		6	BCBR	24	Target Table No 5 Target 34 P17 central	G.F. 2min

J. Holley Capt
 O.C. 107th How Bty

"A" SUB GROUP ARTILLERY.

GAS BOMBARDMENT

For period ending noon 22-7-18.

Unit	Date	Time	Wind		Weather conditions	No of guns.		Target	Method.
			Dir.	M.P.H.		No of rounds	Nature.		
107th	22-7-18.	1.12 am.	S.W.	1	Dry	2 guns	22 BHC	No. 36.	G.F.
do	do	1.18 am.	S.W.	1	Dry	2 guns,	22 BHC	No. 34.	G.F.
do	do	2.4 am.	Calm		Dry	2 guns,	22 BHC	No. 42	G.F.
do	do	2.15 am.	Calm		Dry	2 guns	10 BHC	No. 42	G.F.

K.D. Watson Lieutenant,
Adjutant, "A" Sub Group Artillery.

APPENDIX

49 152

123

"A" SUB GROUP ARTILLERY.

GAS BOMBARDMENT

For period ending noon 23-7-18.

Unit	Time	Date	Wind		Weather conditions	No of rounds.		Target	Method.
			Dir.	M.P.H.		No of guns.	Nature.		
107th	10.40 pm	22nd	S.W. by W.	3	Cloudy	3 guns, 18 BGR	Area 42	G.F.	
do	10.40 pm.	22nd	S.W. by W.	3	Cloudy	3 guns, 18 BGR	Area 43	G.F.	
do	10.35 pm.	22nd	S.W. by W.	6	Cloudy	6 guns, 18 BGR	P.24 d.& c.	G.F.	
do	2.25 a.m.	23rd	S.W. by W.	6.	Cloudy	6 guns, 18 BGR	P.24.b.& c.	G.F.	

K.D. Watson
Adjutant, "A" Sub Group Field Artillery.

Lieutenant,

Gas Bombardment

107th Hvy Bty

7th L.A. B

23 / 7 / 18

Date & Time	Wind Dir & MPH	Weather Conditions	No. of Obs	Nature of gas	Mod. Rds	Nature and Location of target	Method of Firing
10.40 pm	SW by S 2	cloudy	3	BCBR	18	Task Table No 8 Area 42	I.F. 2 min
10.40 pm	SW by S 2	cloudy	3	BCBR	18	Task Table No 8 Area 43	I.F. 2 minutes
10.35 pm	S. W. by S 2	cloudy	6	BCBR	18	Instruction No 4 Sgt X	I.F. 1 minute
12.25	calm	cloudy	6	BCBR	18	Instruction No 4 Sgt X	I.F. 1 minute

per order of

J. Lolley Capt
C. 6 107th Hvy Bty

RIGHT GROUP ARTILLERY.

GAS BOMBARDMENT.

For period ending 12 noon 25-6-18. (24 hours)

Unit	Time	Date	Wind		Weather Conditions	No of rounds		Target	Method of fire
			Dir	M.P.H.		No of guns	Nature.		
107th	10 p.m.	24-6-18.	W. by S.	7	Misty	2 guns,	30 BNC	Gas Target 15	G.F.
"	11.15 pm	"	West	6	"	2 guns,	30 BNC	Gas Target 13	G.F.
"	1.15 a.m.	25-6-18.	"	7	"	2 guns,	40 BNC	Gas Target 4.	G.F.
108th	10 p.m.	24-6-18.	W. by S.	7	"	2 guns,	60 BNC	Gas Target 15.	G.F.
"	11.15 pm.	"	West	6	"	2 guns,	68 BNC	Gas Target 13.	G.F.
"	1.15 a.m.	25-6-18.	"	7	"	2 guns,	60 BNC	Gas Target 4.	G.F.

K.D. Watson
 Adjutant, Right Group Artillery. Lieutenant,

APPENDIX

49
1918

GAS BOMBARDMENT

"A" SUB GROUP FIELD ARTILLERY.

For period ending noon 26th July 1918.

133

Bty	Time	Date	Wind Dir.	M.F.H.	Weather conditions	No of rounds No of guns. Nature.	Target	Method.
107th	10 p.m.	25th	S.W.	1.	Cloudy.	6 guns, 30 BHC	Area 34.	G.F.

K. D. Watson
Adjutant, "A" Sub Group Field Artillery.. Lieutenant.

APPENDIX
49
133

CAS BOMBARDMENT.

"A" SUB GROUP FIELD ARTILLERY.

For period ending 27th July 1918. (12 noon)

133

Unit	Date	Time	Wind. Dir. N.E.S.W.	Weather conditions.	No of rounds. No of guns. Nature.	Target	Method.
107th	27th	1 a.m.	S.W. by W. 2.	Cloudy	6 guns, 36 BHC	Area 36.	G.F.
do	27th	1.3 am.	do 2.	Cloudy	6 guns, 16 BHC 20 BCG	Area 36.	G.F.
do	27th	1.56 am.	do 2.	Cloudy.	6 guns, 36 BHC	Area 34.	G.F.

Wind unfavourable for shoot at 1.59 a.m. 3X fired.

K D Watson Lieutenant,
Adjutant, "A" Sub Group Field Artillery.

APPENDIX

49 157

Gas Bombardment

107th Hqs Bty

29/7/18

Date + Time	Wind MPH Dir	Weather Conditions	No of Ans	Nature of gas	No of Rds	Area and Location Target	Method of Fire
2.30 to 2.35	Calm	Misty	6	BCG	102	P30 a 6.40	G.F. Mine
2.35 2.45	5-2-45		6	BNC	360	" " "	2 rds per minute
2.55 am 3-15 PM	5-3-45		6	BNC	360	" " "	Tash " " " "
3-25	3-25		6	BNC	240	" " "	Table " " " "
3-35 3-25		"	6	BNC	240	" " "	No 17 " " " "
7 am			6	BCG	48	Area B	" " " "
							" " " "

W. C. 107 Hqs Bty

A. SUB GROUP ARTILLERY.

((

DATE. 30-7-18.

133

GAS BOMBARDMENT.

Battery.	Time.	Wind.	Weather Conditions.	No of Guns	Nature of Gas	No of rds	Nature and location of Target	Method of fire.
107th	2-30 to 2-35a.m.	Calm	Misty	6	BCG	102	P. 30. a. 6. 4.	G.F. 5 mins
	2-45 to 3-15a.m.	"	"	6	BNC	360	do)	2 rds p.h.p.m.
	3-25 to 3-55a.m.	"	"	6	BNC	360	do)	do
	4-15 to 4-35a.m.	"	"	6	BNC	240	do)	do
	4-55 to 5-15a.m.	"	"	6	BNC	240	do)	do
	7-0 to 7-4a.m.	"	"	6	BCG	48	AREA B)	do

K.D. Watson

Lieutenant,
Adjutant, A. Sub Group Artillery.

APPENDIX 49 133

"A" SUB GROUP ARTILLERY.

GAS BOMBARDMENT.

For period ending noon 31-7-18.

133

Unit.	Time	Date	Wind. Dir. M.P.H.	Weather conditions.	No of guns. No of rounds. Nature.	Target.	Method.
10Wth.	10.3. pm	30th	Calm.	Ground Mist.	6 guns, 48 BNC	Area 34.	GF.
do	10.7. pm	30th	Calm.	Ground Mist.	6 guns, 38 BNC 10 BCG	Area 34	GF.

Adjutant, *K. D. Watson* "A" Sub Group Artillery.

Lieutenant.

APPENDIX

49

160

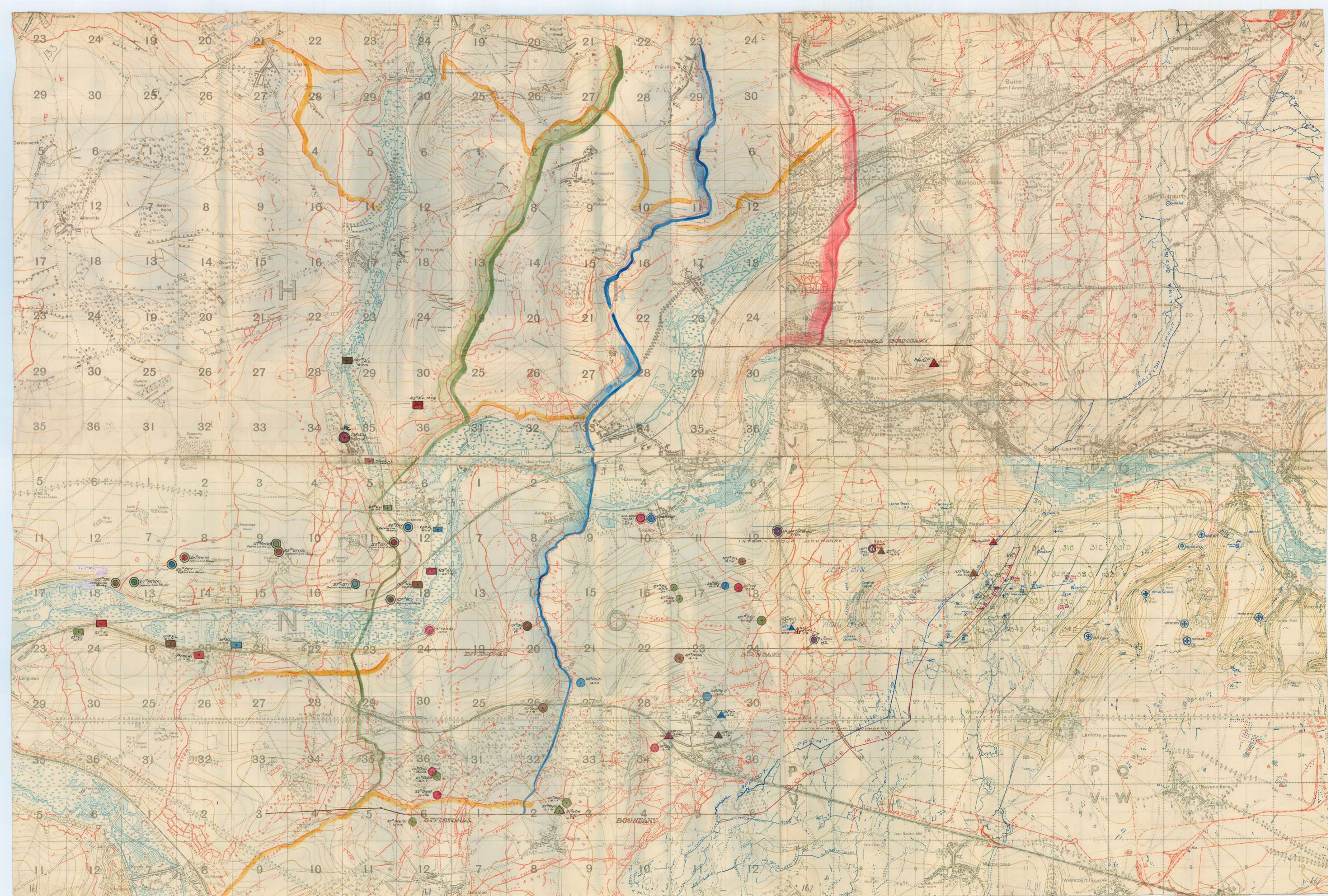

War Diary July

7th AUST. FIELD ARTILLERY BRIGADE.

STRENGTH JULY, 1918.

	<u>Off.</u>	<u>O.R's.</u>
JULY, 1st.	33	807.
JULY, 31st.	37	844.

7th AUST. FIELD ARTILLERY BRIGADE.

CASUALTIES FOR MONTH OF JULY, 1918.

	<u>Off.</u>	<u>O.R's.</u>
Killed in action.	--	--
Wounded.	-	3
Wounded (R.O.D.)	-	1

7th AUST. FIELD ARTILLERY BRIGADE.

SCHOOLS ATTENDED DURING JULY, 1918.

	<u>Off.</u>	<u>O.R's.</u>
4th Army Signal School	-	2.
3rd Div. Fitter's Course.	-	8.
4th Army Artillery School.	2	4.
4th Army Camouflage School.	-	1.
4th Army Veterinary School.	-	1.