

**Series: AWM95**  
Australian Army commanders' diaries

Headquarters

**Item number: 1/4/228**

**Item: Headquarters, 1 Australian  
Task Force**

Annex C

1-31 July 1971

SECRET

CD 15

AWM 95  
[1/4/Jul 71 Part 2]

# 1st AUSTRALIAN TASK FORCE VIETNAM



ORIGINAL JUL 71

---

COMMANDER'S DIARY

---

SECRET

AFV/MISC/2174

ANNEX C TO COMMANDER'S DIARY OF HQ 1 ATF

FROM / TO 99

OTHER PAPERS, EG, MAPS AND DIAGRAMS ETC

SECRET

569/2/296

Copy No of Copies

Headquarters  
1st Australian Task force  
NUI DAT

3/ Jul 71

OpO 8/71 (continuation Op IRON FOX)

Reference Maps: A. 6430 I SW  
B. 6430 II NW  
C. 6430 III NE  
D. 6430 IV SE

Reference: A. 1 ATF OpO 7/71

Time zone used throughout this order: HOTEL

1. Situation

- a. Enemy Forces. Elements of the enemy, identified as 1st Battalion 274 Regiment, were contacted in the objective area. It is considered that remnants of 1/274 may now be located in the general vicinity of the SUOI CA and SUOI SOC, centre of mass YS380890. It is also possible that elements of Sub-Region 4 may be in this area.
- b. Friendly Forces.
- (1) Task Organisation: No change.
- (2) In Co-operation: No change except that C Bty (-) 5/42 (US) Arfy Bn withdrew from in general support 1 ATF at 0630 hrs 31 Jul 71. (Not mentioned further in this order).

2. Mission To destroy enemy forces located in the area of the SUOI CA and the SUOI SOC, centre of mass YS380890.

3. Execution.

- a. General Outline 3 RAR (-) and 4 RAR/NZ(ANZAC) (-) advance to the southwest astride the SUOI SOC against a cavalry/infantry blocking force on the BRIMSTONE TRAIL.
- b. 3 RAR (-).
- (1) Grouping. No change except:
- (a) Reverting from under command C Coy 3 RAR  
HQ 1 ATF 29 Jul 71
- (b) Under operational control C Sqn (-) 1 Armd Regt  
from L Hour
- (2) Task. To advance on the general line of the SUOI CA to attack and destroy the enemy within boundaries shown at Annex A.

/c. 4 RAR/NZ(ANZAC)

SECRET

- c. 4 RAR/NZ(ANZAC) (-)
- (1) Grouping. No change except:
- (a) Changing from under operational control from L Hour C Sqn (-) 1 Armd Regt
- (b) Changing to under operational control HQ 1 ATF from time of arrival in NUI DAT on 2 Aug 71 B Coy 4 RAR/NZ(ANZAC)
- (2) Task. To advance south of the line of the SUOI SOC to attack and destroy the enemy within boundaries shown at Amex A.
- d. C Sqn (-) 1 Armd Regt
- (1) C Sqn (-) (less one tp) changes to under operational control 3 RAR, right attack force, at L Hour.
- (2) One tp remains NUI DAT, 1 ATF Ready Reaction Force (by night).
- e. A Sqn (-) 3 Cav Regt.
- (1) A Sqn (-) with under operational control one company 4 RAR/NZ(ANZAC) is to block in the position shown at Amex A.
- (2) Other tasks as shown in OpO 7/71
- (3) In DS from 0600 hrs 1 Aug - one RW ac of 161 (Indep) Recce Flt.
- f. SAS
- (1) Patrol ~~32~~<sup>34</sup> has moved to a new location as shown in Amex A.
- (2) Patrol 24 will be extracted on orders from HQ 1 ATF.
- (3) Patrols 13 and 21 remain until extraction ordered by HQ 1 ATF.
- (4) One additional patrol to be inserted as shown in Amex A. Timings to be advised by HQ 1 ATF.
- g. 161 (Indep) Recce Flt. No change except additionally from 0600 hrs 1 Aug - one RW ac in DS A Sqn (-) 3 Cav Regt.
- h. Other Units. No change from OpO 7/71.
- i. Co-ordinating Instructions.
- (1) Boundaries and locations are as shown in Amex A. SUOI SOC inclusive to 3 RAR.
- (2) Assembly areas and start lines are to be co-ordinated where needed by 3 RAR.
- (3) Change of operational control C Sqn (-) 1 Armd Regt is to be co-ordinated by 3 RAR.

/(4) Change

SECRET

-3-

- (4) Change of operational control of one company 4 RAR/NZ (ANZAC) to under operational control A Sqn (-) 3 Cav Regt is to be co-ordinated by A Sqn.
  - (5) All timings including issue of L Hour are to be issued by HQ 1 ATF.
  - (6) Co-ordination of advancing elements of both battalions astride the SUOI SOC is to be effected by 3 RAR.
  - (7) Air. No change.
4. Administration and Logistics. No change.
  5. Command and Signal. No change.

Ack Instr: Ack

Authentication:

(B.A. McDONALD)  
Brig  
Comd

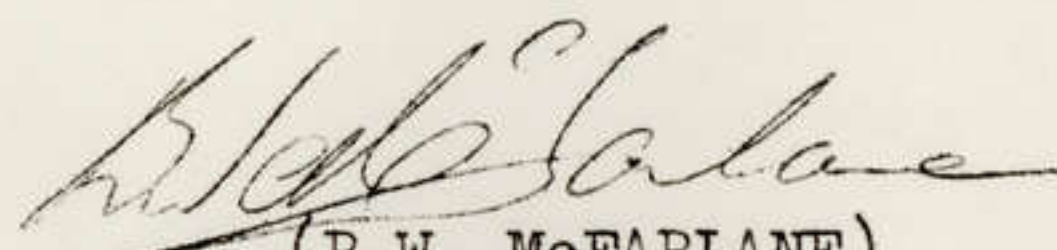
  
(B.W. McFARLANE)  
Maj  
GS02 (Ops)

Annexes: A. Boundaries and Locations

Distribution:

List Z

SECRET

SECRET

# OPERATION IRON FOX

SCALE 1:25,000

ANNEX A to  
1ATF OPO 8/71  
DATED 31 Jul 71

Ref Maps: 6430-I - SW  
6430-II - NW  
6430-III - NE  
6430-IV - SE

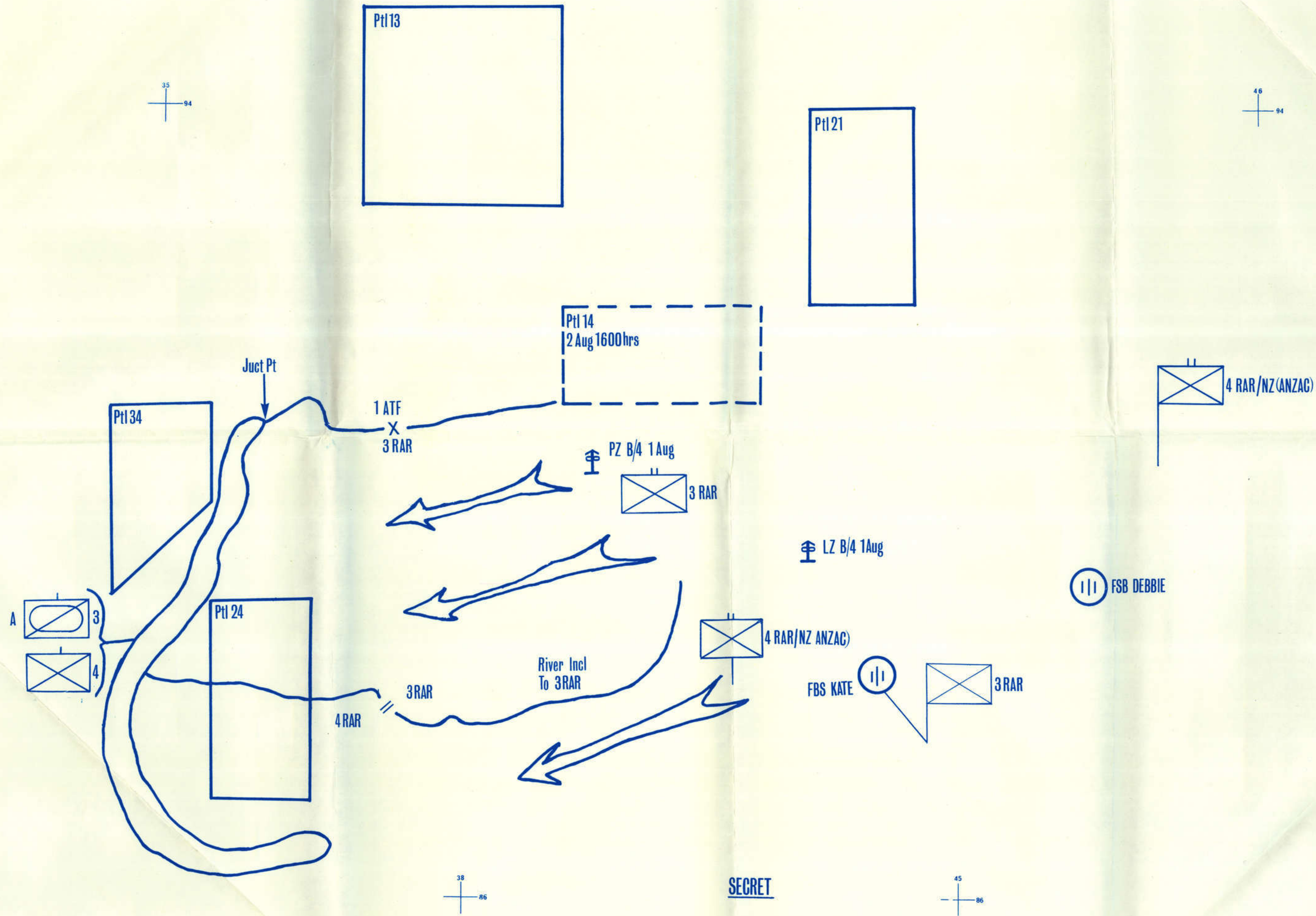

SECRET

CONFIDENTIAL

AUSTRALIAN ARMY

R617/1/4

HQ 1 ATF  
NUI DAT

2 Jul 71

Distribution List below:

1 ATF PATROL PROGRAMME

1. Attached is the 1 ATF patrol programme for the period 040800H Jul 71 to 110800H Jul 71.

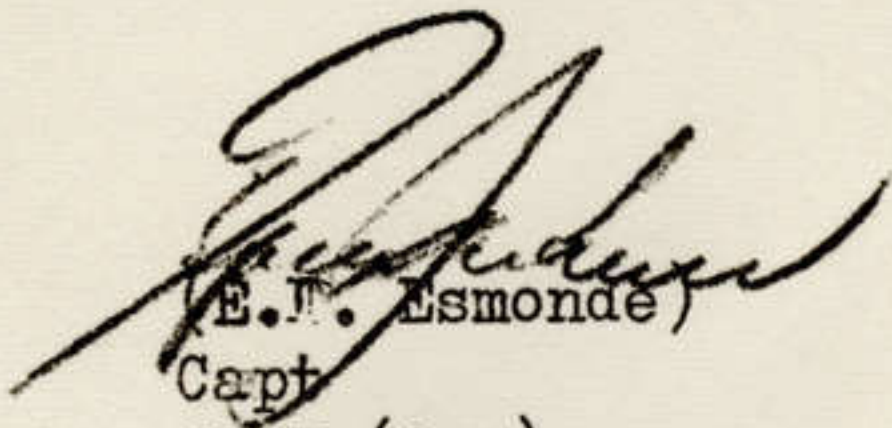
  
(E.J. Esmonde)  
Capt  
GS03 (Ops)

Distribution

C Sqn 1 Armd Regt	(3)
A Sqn 3 Cav Regt	(2)
12 Fd Regt	(9)
1 Fd Sqn RAE	(3)
21 Engr Sp Tp	(2)
17 Const Sqn	(2)
104 Sig Sqn	
547 Sig Sqn	
4 RAR/NZ (ANZAC)	(13)
3 RAR	(11)
2 SAS Sqn	
1 ARU	(10)
161 (Indep) Recce Flt	
TFMA	(3)
HQ Coy 1 ATF	
106 Fd Wksp	
1 ATF CP	
GS02 (Ops)	
GS03 (Ops)	
GS03 (SD & Trg)	
ATOC	
LO DUC THANH	
LO ONG LE	
File	
Float	
Diary	(2)
Apares	(5)

CONFIDENTIAL



CONFIDENTIAL

2 SAS SQN PATROL FORECAST FOR PERIOD 04 JUL 71 TO 11 JUL 71

Ptl Ser No	T/192	T/193	T/194	T/195
Sub Unit	1 Fd Sqn	17 Const Sqn	2 SAS SQN	HQ Coy 1 ATF
C/S and Freq	59 Freq at Sig Brief	59 Freq at Sig Brief	59 Freq at Sig Brief	59 Freq at Sig Brief
Controlled by	2 SAS SQN C/S 21	2 SAS SQN C/S 21	2 SAS SQN C/S 21	2 SAS SQN C/S 21
Task	Sector 9 Standing Ptl YS 432679	Sector 9 Standing Ptl YS 429675	Sector 9 Standing Ptl YS 433679	Sector 9 Standing Ptl YS 432680
Strength	1 : 5	1 : 5	1 : 5	1 : 5
Date Time Insertion	041930H Jul 71	051930H Jul 71	061930H Jul 71	071930H Jul 71
Date Time Extraction	050700H Jul 71	060700H Jul 71	070700H Jul 71	080700H Jul 71
Route out	As per brief	As per brief	As per brief	As per brief
Route in	As per brief	As per brief	As per brief	As per brief
Remarks	Ptl Comd and Sig Brief 2 SAS SQN 040900H Jul 71	Ptl Comd and Sig Brief 2 SAS SQN 050900H Jul 71	Ptl Comd and Sig Brief 2 SAS SQN 060900H Jul 71	Ptl Comd and Sig Brief 2 SAS SQN 070900H Jul 71

---

Ptl Ser No	T/196	T/197	T/198
Sub Unit	1 Fd Sqn	17 Const Sqn	2 SAS SQN
C/S and Freq	59 Freq at Sig Brief	59 Freq at Sig Brief	59 Freq at Sig Brief
Controlled by	2 SAS SQN C/S 21	2 SAS SQN C/S 21	2 SAS SQN C/S 21
Task	Sector 9 Standing Ptl YS 432679	Sector 9 Standing Ptl YS 429675	Sector 9 Standing Ptl YS 433679
Strength	1 : 5	1 : 5	1 : 5
Date Time Insertion	081930H Jul 71	091930H Jul 71	101930H Jul 71
Date Time Extraction	090700H Jul 71	100700H Jul 71	110700H Jul 71
Route Out	As per Brief	As per brief	As per brief
Route In	As per brief	As per brief	As per brief
Remarks	Ptl Comd and Sig Brief 2 SAS SQN 080900H Jul 71	Ptl Comd and Sig Brief 2 SAS SQN 090900H Jul 71	Ptl Comd and Sig Brief 2 SAS SQN 100900H Jul 71

CONFIDENTIAL

CONFIDENTIAL

4 RAR/NZ(ANZAC) BN PATROL FORECAST FOR PERIOD 03 JUL 71 TO 11 JUL 71

Ptl Serial Number	9/71	10/71	11/71
Sub Unit to provide	Admin Coy 4 RAR/NZ	Admin Coy 4 RAR/NZ(ANZAC) Bn	Sp Coy 4 RAR/NZ(ANZAC) Bn
Callsign - Frequency	71 Bn CP	75 Bn CP	71 Bn CP
Controlled by	4 RAR/NZ(ANZAC) Bn	4 RAR/NZ(ANZAC) Bn	4 RAR/NZ(ANZAC) Bn
Task	Cancelled	Ni 03/04 Jul Ambush Grid 387701	Ni 07/08 Jul Ambush Grid 398698
		Day 04 Jul Standing Patrol Grid	Day 08 Jul Standing Patrol Grid
		375681 and Recce Grid Square 3768	398687
		Ni loc 04/05 Jul Grid 375681	Ni 08/09 Jul Ambush Grid 383692
		Day 05 Jul Standing Patrol Grid	Day 09 Jul Standing Patrol Grid
		373669 and Recce Grid Square 3667 and	376703 and Recce Grid Square 3770
		3766	Ni loc 09/10 Jul Grid 376703
		Ni 05/06 Jul Ambush Grid 379666	Day 10 Jul Standing Patrol Grid
		Day 06 Jul Standing Patrol Grid	369694 and Recce Grid Squares 3669
		374651	and 3668
	Ni 07/07 Jul Ambush Grid 373643	Ni 10/11 Jul Ambush Grid 365688	
Strength		1 x 10	1 x 10
Route Out		Drop Off Grid 425688	Drop Off Grid 422684
Route In		Pick Up Grid 421668	Pick Up Grid 419676
Date/Time Out		031400H	071500H
Date/Time In		071000H	110930H
Remarks		Tpt - 1 x TCV 4 RAR/NZ 1 x escort Admin Coy Patrol Comd for briefing to RSM 020930H	Tpt - 1 x TCV 4 RAR/NZ 1 x escort Sp Coy Patrol Comd for briefing to RSM 060930H

CONFIDENTIAL  
1 ARU PATROL TASK TABLE  
FOR PERIOD FROM 040800H TO 110800H JUL 71

A	Serial No	185/71	186/71	187/71
B	Sub unit to provide	1 ARU Platoon	1 ARU Platoon	1 ARU Platoon
C	Call sign and frequency	56 55.40 alt 59.35	56 55.40 alt 59.35	56 55.40 alt 59.35
D	Controlled by	1 ARU	1 ARU	1 ARU
E	Task	Standing ptl AO LUGARNO Ni loc vic 457643	Standing ptl AO LUGARNO Ni loc vic 437643	Standing ptl AO LUGARNO Ni loc vic 445644
F	Strength	1 : 8	1 : 8	1 : 8
G	Date/time out	041500H	051500H	061500H
H	Date/time in	050800H	060800H	070800H
J	Route	Direct	Direct	Direct
K	Remarks	Bdry clearance will be requested AM 4 Jul 71	Bdry clearance will be requested AM 5 Jul 71	

A	188/71	189/71	190/71	191/71
B	1 ARU Platoon	1 ARU Platoon	1 ARU Platoon	1 ARU Platoon
C	56 55.40 alt 59.35	56 36.45 alt 49.35	56 36.45 alt 49.35	56 36.45 alt 49.35
D	1 ARU	1 ARU	1 ARU	1 ARU
E	Standing ptl AO LUGARNO Ni loc vic 443630	Standing ptl AO LUGARNO Ni loc vic 454633	Standing ptl AO LUGARNO Ni loc vic 458642	Standing ptl AO LUGARNO Ni loc vic 445640
F	1 : 8	1 : 8	1 : 8	1 : 8
G	071500H	081500H	091500H	101500H
H	080800H	090800H	100800H	110800H
J	Direct	Direct	Direct	Direct
K	Bdry clearance will be requested AM 7 Jul 71 Freq change 072400H Main 36.45 alt 49.35	Bdry clearance will be requested AM 8 Jul 71	Bdry clearance will be requested AM 9 Jul 71	

CONFIDENTIAL

CONFIDENTIAL

R617/1/4

3

HQ 1 ATF  
NUI DAT

3 Jul 71

Distribution List Below:

1 ATF PATROL PROGRAMME : 4-11 JUL 71  
AMENDMENT NO 1

1. The above Patrol Programme is amended by deleting existing 4 RAR/NZ(ANZAC) forecast and inserting the new one attached.

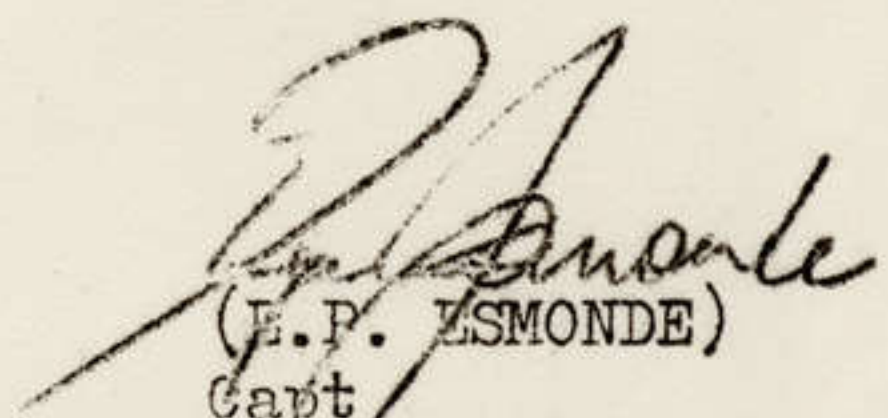
  
(E.P. ESMONDE)  
Capt  
GS03 (Ops)

Distribution:

C Sqn 1 Armd Regt	(3)
A Sqn 3 Cav Regt	(2)
12 Fd Regt RAA	(9)
1 Fd Sqn RAE	(3)
17 Const Sqn	(2)
21 Engr Sp Tp	(2)
104 Sig Sqn	
547 Sig Tp	
3 RAR	(11)
4 RAR/NZ(ANZAC)	(13)
2 SAS Sqn	
1 ARU	(10)
161 (Indep) Recce Flt	
TFMA	(3)
HQ Coy 1 ATF	
106 Fd Wksp	
1 ATF CP	
GS02 (Ops)	
GS03 (Ops)	
GS03 (SD and Trg)	
ATOC	
LO DUC THANH	
LO LONG LE	
File	
Float	
Diary	(2)
Spares	(5)

CONFIDENTIAL

AMENDMENT COPY

CONFIDENTIAL

4 RAR/NZ (ANZAC) BN PATROL FORCAST FOR PERIOD 03 JUL 71 TO 11 JUL 71

Ftl Serial Number	10/71	11/71	12/71	13/71
Sub Unit to Prov	Adm Coy 4 RAR/NZ	Sp Coy 4 RAR/NZ	Adm Coy 4 RAR/NZ	Sp Coy 4 RAR/NZ
Callsign-Frequency	7.5 Bn CP	7.1 Bn CP	7.1 Bn Cp	7.5 Bn CP
Controlled by	4 RAR/NZ (ANZAC) BN			
Task	Cancelled	Cancelled	Ni 03/04 Jul ambush GR 398698	Ni 07/08 Jul ambush GR 307701
			Day 04 Jul Standing Ptl GR 398687	Day 08 Jul Standing Ptl GR 375681-Recce G/S37-68
			Ni 04/05 Jul ambush GR 383692	Ni Loc 08/09 Jul G375681 Day 09 Jul Standing Ptl
			Day 05 Jul Standing Ptl GR 376703-Recce G/S 37-70	GR358682- Recce G/S35-68 Ni 09/10 Jul ambush
			Ni Loc 05/06 Jul G376703 Day 06 Jul Standing Ptl	GR 357676 Day 10 Jul standing Ptl
			GR 369694-Recce G/S 36-69 and 36-38	GR 375669-Recce G/S 36-67 and 37-66
			Ni 06/07 Jul ambush GR 365688	Ni 10/11 Jul ambush GR 379666
Strength			1 & 9	1 & 9
Route Out			Drop off GR 422684	Drop off GR 425688
Route In			Pick up GR 419676	Pick up GR 421668
Date/Time Out			031400 H	071300 H
Date/Time In			071000 H	111030 H
Remarks			Tpt-1 TCV 4 RAR/NZ 1 Escort Adm Coy Ptl comd for brief 020930 H to RSM	Tpt 1 TCV 4 RAR/NZ 1 Escort Sp Coy Ptl comd for brief 060930 H to RSM

4

CONFIDENTIAL  
AUSTRALIAN ARMY

R617/1/4

Headquarters  
1st Australian Task Force  
NUI DAT

9 Jul 71

Distribution Below:

1 ATF PATROL PROGRAMME

1. Attached is the 1 ATF patrol programme for the period  
110800H Jul 71 to 180800H Jul 71.

  
E.P. ESMONDE)  
Capt  
GSO3 (Ops)

Distribution:

C Sqn 1 Armd Regt	(3)
A Sqn 3 Cav Regt	(2)
12 Fd Regt	(9)
1 Fd Sqn RAE	(3)
21 Engr Tp	(2)
17 Const Sqn	(2)
104 Sig Sqn	
547 Sig Sqn	
4 RAR/NZ(ANZAC)	(13)
3 RAR	(11)
2 SAS Sqn	
1 ARU	(10)
161 (Indep) Recce Flt	
TFMA	(3)
HQ Coy 1 ATF	
106 Fd Wksp	
1 ATF CP	
GS02 (Ops)	
GS03 (Ops)	
GS03 (SD and Trg)	
ATOC	
LO DUC THANH	
LO LONG LE	
File	
Float	
Diary	(2)
Spares	(5)

CONFIDENTIAL

CONFIDENTIAL

4 RAR/NZ(ANZAC) BN PATROL FORECAST FOR PERIOD 11 JUL TO 18 JUL 71

Ptl Serial Number	14/71	15/71	
sub unit to provide	1 ARU	104 Sig	
Callsign-Frequency	73 BN CP	71 BN CP	
Controlled by	4 RAR/NZ(ANZAC) Bn		
Task	NI 11/12 JUL AMBUSH	NI 15/16 JUL AMBUSH	
	G 398669	G 393673	
	DAY 12 JUL STANDING PATROL G 401677	DAY 16 JUL STANDING PATROL G388682	
	NI 12/13 JUL AMBUSH	NI 16/17 AMBUSH	
	G 413690	G 394693	
	DAY 13 JUL STANDING PATROL G 400702	DAY 17 JUL STANDING PATROL G 397705	
	NI 13/14 JUL AMBUSH	NI 17/18 AMBUSH	
	G 394702	G 393705	
	DAY 14 JUL STANDING PATROL G 400705		
	NI 14/15 JUL AMBUSH		
	G 419705		
	Strength	1X1 <sup>0</sup>	1X10
Route Out	Drop off G 419678	Drop off G 419679	
Route In	Pick up G 428692	Pick up 427691	
Date/Time out	111500H	151530H	
Date/Time In	150900H	180945H	
Remarks	Tpt - 1XTCV from 4 RAR/NZ ) report 1 ARU 111445H 1X escort Adj coy 4 RAR /NZ. Patrol Comd for brief -ing to RSM 4RAR/NZ 100930H	Tpt from 104 Sig plus 1X Escort Patrol Comd for brief- ing to RSM 4 RAR/NZ 140939H	

CONFIDENTIAL

2 SAS SQN PATROL FORECAST FOR PERIOD 11 JUL 71 TO 18 JUL 71

A.	Ptl Ser No	T/199	T/200	T/201	T/202
B.	Sub Unit	1 Fd Sqn	17 Const Sqn	2 SAS SQN	1 Fd Sqn
C.	C/S and Freq	59 Freq at Sig brief	59 Freq at Sig brief	59 Freq at Sig brief	59 Freq at Sig brief
D.	Controlled by	2 SAS SQN C/S 21	2 SAS SQN C/S 21	2 SAS SQN C/S 21	2 SAS SQN C/S 21
E.	Task	Sector 9 Standing Ptl YS 432679	Sector 9 Standing Ptl YS 432680	Sector 9 Standing Ptl YS 429675	Sector 9 Standing Ptl YS 433679
F.	Strength	1 : 5	1 : 5	1 : 5	1 : 5
G.	Date Time Insertion	111930H Jul 71	121930H Jul 71	131930H Jul 71	141930H Jul 71
H.	Date Time Extraction	120700H Jul 71	130700H Jul 71	140700H Jul 71	150700H Jul 71
I.	Route Out	As per brief	As per brief	As per brief	As per brief
J.	Route In	As per brief	As per brief	As per brief	As per brief
K.	Remarks	Ptl Comd and Sig Brief 2 SAS SQN 110900H Jul 71	Ptl Comd and Sig Brief 2 SAS SQN 120900H Jul 71	Ptl Comd and Sig Brief 2 SAS SQN 130900H Jul 71	Ptl Comd and Sig Brief 2 SAS SQN 140900H Jul 71

---

A.	Ptl Ser No	T/203	T/204	T/205
B.	Sub Unit	17 Const Sqn	2 SAS SQN	1 Fd Sqn
C.	C/S and Freq	59 Freq at Sig Brief	59 Freq at Sig Brief	59 Freq at Sig Brief
D.	Controlled by	2 SAS SQN C/S 21	2 SAS SQN C/S 21	2 SAS SQN C/S 21
E.	Task	Sector 9 Standing Ptl YS 432680	Sector 9 Standing Ptl YS 429675	Sector 9 Standing Ptl YS 432679
F.	Strength	1 : 5	1 : 5	1 : 5
G.	Date Time Insertion	151930H Jul 71	161930H Jul 71	171930H Jul 71
F.	Date Time Extraction	160700H Jul 71	170700H Jul 71	180700H Jul 71
G.	Route Out	As per brief	As per brief	As per brief
H.	Route In	As per brief	As per brief	As per brief
I.	Remarks	Ptl Comd and Sig brief 2 SAS SQN 150900H Jul 71	Ptl Comd and Sig Brief 2 SAS SQN 160900H Jul 71	Ptl Comd and Sig Brief 2 SAS SQN 170900H Jul 71



CONFIDENTIAL  
1 ARU PATROL TASK TABLE  
FOR PERIOD FROM 110800H TO 180800H JUL 71

A	Serial No	192/71	193/71	194/71
B	Sub unit to provide	To be advised	To be advised	To be advised
C	Call sign and frequency	56 36.45 alt 49.35	56 36.45 alt 49.35	56 36.45 alt 49.35
D	Controlled by	1 ARU	1 ARU	1 ARU
E	Task	Standing ptl AO LUGARNO	Standing ptl AO LUGARNO	Standing ptl AO LUGARNO
F	Strength	Ni loc vic 457643	Ni loc vic 437643	Ni loc vic 435639
G	Date/time out	1 : 8	1 : 8	1 : 8
H	Date/time in	111500H	121500H	131500H
J	Route	120800H	130800H	140800H
K	Remarks	Direct	Direct	Direct
		Bdry clearance will be requested AM 11 Jul 71	Bdry clearance will be requested AM 12 Jul 71	Bdry clearance will be requested AM 13 Jul 71
A	195/71	196/71	197/71	198/71
B	To be advised	To be advised	To be advised	To be advised
C	56 36.45 alt 49.35	56 35.85 alt 55.00	56 35.85 alt 55.00	56 35.85 alt 55.00
D	1 ARU	1 ARU	1 ARU	1 ARU
E	Standing ptl AO LUGARNO	Standing ptl AO LUGARNO	Standing ptl AO LUGARNO	Standing ptl AO LUGARNO
F	Ni loc vic 451650	Ni loc vic 453632	Ni loc vic 436646	Ni loc vic 445640
G	1 : 8	1 : 8	1 : 8	1 : 8
H	141500H	151500H	161500H	171500H
J	150800H	160800H	170800H	180800H
K	Direct	Direct	Direct	Direct
	Freq change 142400H Main 35.85 alt 55.00	Bdry clearance will be requested AM 15 Jul 71	Bdry clearance will be requested AM 16 Jul 71	

CONFIDENTIAL  
AUSTRALIAN ARMY

5

R617/1/4

Headquarters  
1st Australian Task Force  
NUI DAT

15 Jul 71

Distribution Below:

1 ATF PATROL PROGRAMME - 110800H TO 180800H JUL 71  
AMENDMENT NO 1

1. The above programme is amended by deleting existing  
4 RAR/NZ(ANZAC) patrol forecast and inserting the one attached.

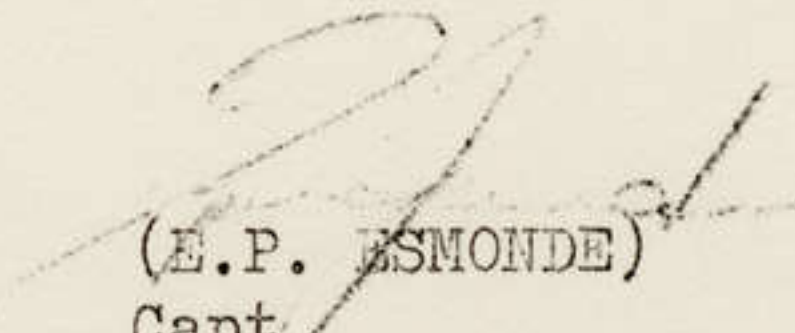
  
(E.P. ESMONDE)  
Capt.  
GS03 (Ops)

Distribution:

C Sqn 1 Armd Regt	(3)
A Sqn 3 Cav Regt	(2)
12 Fd Regt	(9)
1 Fd Sqn RAE	(3)
21 Engr Tp	(2)
17 Const Sqn	(2)
104 Sig Sqn	
547 Sig Sqn	
4 RAR/NZ(ANZAC)	(13)
3 RAR	(11)
2 SAS Sqn	
1 ARU	(10)
161 (Indep) Recce Flt	
TFMA	(3)
HQ Coy 1 ATF	
106 Fd Wksp	
1 ATF CP	
GS02 (Ops)	
GS03 (Ops)	
GS03 (SD and Trg)	
ATOC	
LO DUC THANH	
LO LONG LE	
File	
Float	
Diary	(2)
Spares	(5)

CONFIDENTIAL

CONFIDENTIAL

AMENDMENT

4 RAR/NZ(ANZAC) BN PATROL FORECAST FOR PERIOD 11 JUL TO 18 JUL 71

Ptl Serial Number	14/71	15/71	16/71	17/71
Sub Unit to provide	1 ARU	104 Sig Sqn	104 Sig Sqn	Admin Coy 4 RAR/NZ(ANZAC) Bn
Callsign-Frequency	73 Bn CP	71 Bn CP	71 Bn CP	74 Bn CP
Controlled by	4 RAR/NZ	4 RAR/NZ	4 RAR/NZ	4 RAR/NZ
Task	Cancelled	Cancelled	Ni 12/13 Jul Ambush Grid 397666	Ni 15/16 Jul Ambush Grid 398669
			Day 13 Jul Standing Patrol	Day 16 Jul Standing Patrol
			Grid 402675	Grid 382655
			Ni 13/14 Jul Ambush Grid 393673	Ni 16/17 Jul Ambush Grid 383648
			Day 14 Jul Standing Patrol	Day 17 Jul Standing Patrol
			Grid 398678	Grid 374651
			Ni 14/15 Jul Ambush Grid 387684	Ni 17/18 Jul niloc Grid 374651
				Day 18 Jul Recce GS 3764
				Ni 18/19 Jul Ambush Grid 373645
				Day 19 Jul Standing Patrol
				Grid 375655
				Ni 19/20 Jul Ambush Grid 380643
Strength			1 & 10	1 & 10
Route Out			Drop Off Grid 419679	Drop Off Grid 418675
Route In			Pick Up Grid 427691	Pick Up Grid 383628
Date/Time Out			121530H	151600H
Date/Time In			150945H	200800H
Remarks			Tpt from 104 Sig Sqn plus 1 x escort Patrol Comd briefed 110930H	Tpt - 1 x TCV 4 RAR/NZ plus 1 x escort Admin Coy Patrol Comd for briefing to RSM 130830H

6

CONFIDENTIAL

AUSTRALIAN ARMY

R617/1/4

Headquarters  
1st Australian Task Force  
NUI DAT

Distribution Below:

1/6 Jul 71

1 ATF PATROL PROGRAMME

1. Attached is the 1 ATF patrol programme for the period  
180800H Jul 71 to 250800H Jul 71.

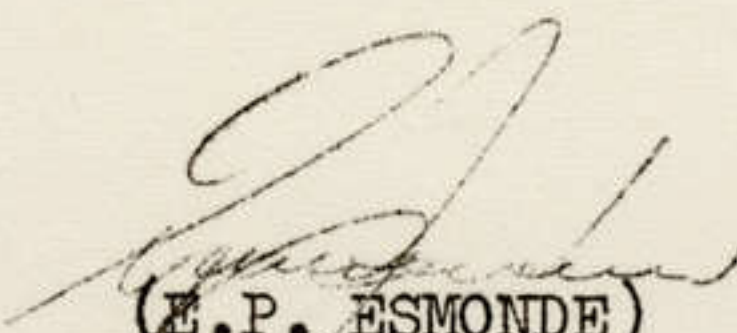
  
(E.P. ESMONDE)  
Capt  
GS03 (Ops)

Distribution:

C Sqn 1 Armd Regt	(3)
A Sqn 3 Cav Regt	(2)
12 Fd Regt	(9)
1 Fd Sqn RAE	(3)
21 Engr Tp	(2)
17 Const Sqn	(2)
104 Sig Sqn	
547 Sig Sqn	
4 RAR/NZ (ANZAC)	(13)
3 RAR	(11)
2 SAS Sqn	
1 ARU	(10)
161 (Indep) Recce Flt	
TFMA	(3)
HQ Coy 1 ATF	
106 Fd Wksp	
1 ATF CP	
GS02 (Ops)	
GS03 (Ops)	
GS03 (SD and Trg)	
ATOC	
LO DUC THANH	
LO LONG LE	
File	
Float	
Diary	(2)
Spares	(5)

CONFIDENTIAL

CONFIDENTIAL

3 RAR PATROL FORECAST FOR PERIOD 18 JUL 71 TO 25 JUL 71

Ptl Serial Number	3/71	4/71		
Sub unit to provide	Admin Coy 3 RAR	Admin Coy 3 RAR		
Callsign - Frequency	98A 56.80	98A 56.80		
Controlled by	3 RAR Base Def CP	3 RAR Base Def CP		
Task	N19/20 Ambush Vic Grid 445702	N 23/24 Ambush Vic Grid 447705		
Strength	NCO & 8	NCO & 8		
Route Out	Direct	Direct		
Route In	Direct	Direct		
Date/Time Out	191815	231815		
Date/Time In	200700	240700		
Remarks	Tpt from 3 RAR Tpt compound to vic grid 442705. Pick up and RTU 200645.	Tpt from 3 RAR tpt compound to vic grid 440701. Pick up and RTU 240645.		

CONFIDENTIAL

2 SAS SQN PATROL FORECAST FOR PERIOD 18 JUL 71 TO 25 JUL 71

A. Ptl Ser No	T/206	T/207	T/208	T/209
B. Sub Unit	17 Const Sqn	2 SAS SQN	1 Fd SQN	17 Const Sqn
C. C/S and Freq	59 Freq at Sig Brief	59 Freq at Sig Brief	59 Freq at Sig Brief	59 Freq at Sig Brief
D. Controlled By	2 SAS SQN C/S 21	2 SAS SQN C/S 21	2 SAS SQN C/S 21	2 SAS SQN C/S 21
E. Task	Sector 9 Standing Ptl YS 432677	Sector 9 Standing Ptl YS 429675	Sector 9 Standing Ptl YS 432680	Sector 9 Standing Ptl YS 433679
F. Strength	1 : 5	1 : 5	1 : 5	1 : 5
G. Date Time Insertion	181930H Jul 71	191930H Jul 71	201930H Jul 71	211930H Jul 71
H. Date Time Extraction	190700H Jul 71	200700H Jul 71	210700H Jul 71	220700H Jul 71
I. Route Out	As per Brief	As per Brief	As per Brief	As per Brief
J. Route In	See Note (1)	As per Brief	As per Brief	As per Brief
K. Remarks	Ptl Comd and Sig Brief 2 SAS SQN 180900H Jul 71	Ptl Comd and Sig Brief 2 SAS SQN 190900H Jul 71	Ptl Comd and Sig Brief 2 SAS SQN 200900H Jul 71	Ptl Comd and Sig Brief 2 SAS SQN 210900H Jul 71

---

A. T/210	T/211	T/212	Note (1)
B. 2 SAS SQN	1 Fd Sqn	17 Const Sqn	Sweep NORTH creek to EASTERN perimeter fence then NORTH to wire on SOUTHERN side of LUSCOMBE then EAST to ROUTE 2 then SOUTH to RV.
C. 59 Freq at Sig Brief	59 Freq at Sig Brief	59 Freq at Sig Brief	
D. 2 SAS SQN C/S 21	2 SAS SQN C/S 21	2 SAS SQN C/S 21	
E. Sector 9 Standing Ptl	Sector 9 Standing Ptl	Sector 9 Standing Ptl	
F. 1 : 5 YS 429675	1 : 5 YS 432677	1 : 5 YS 432680	
G. 221930H Jul 71	231930H Jul 71	241930H Jul 71	
H. 230700H Jul 71	240700H Jul 71	250700H Jul 71	
I. As per Brief	As per Brief	As per Brief	
J. As per brief	See Note (1)	As per Brief	
K. Ptl Comd and Sig Brief 2 SAS SQN 220900H Jul 71	Ptl Comd and Sig Brief 2 SAS SQN 230900H Jul 71	Ptl Comd and Sig Brief 2 SAS SQN 240900H Jul 71	

CONFIDENTIAL

CONFIDENTIAL  
1 ARU PATROL TASK TABLE  
FOR PERIOD FROM 180800H TO 250800H JUL 71

A	Serial No 199/71	200/71	201/71	202/71
B	Sub unit to provide	3 Platoon	3 Platoon	3 Platoon
C	Call sign and frequency	56 - 35.85 alt 55.00	56 - 35.85 alt 55.00	56 - 35.85 alt 55.00
D	Controlled by	1 ARU	1 ARU	1 ARU
E	Task	Standing ptl AO LUARNO ni loc vic 443645	Standing ptl AO LUGARNO ni loc vic 444640	Standing ptl AO LUGARNO ni loc vic 454632
F	Strength	1:8	1:8	1:8
G	Date/time out	181500H	191500H	201500H
H	Date/time in	190800H	200800H	210800H
J	Route	Direct	Direct	Direct
K	Remarks			Bdry clearence will be requested AM 20 Jul 71
A	203/71	204/71	205/71	206/71
	3 Platoon	3 Platoon	3 Platoon	3 Platoon
C	56 - 35.85 alt 55.00	56 - 47.35 alt 59.40	56 - 47.35 alt 59.40	56 - 47.35 alt 59.40
D	1 ARU	1 ARU	1 ARU	1 ARU
E	Standing ptl AO LUGARNO ni loc vic 448641	Standing ptl AO LUGARNO ni loc vic 450635	Standing ptl AO LUGARNO ni loc vic 453641	Standing ptl AO LUGARNO ni loc vic 445636
F	1:8	1:8	1:8	1:8
G	211500H	221500H	231500H	241500H
H	220800H	230800H	240800H	250800H
J	Direct	Direct	Direct	Direct
K	Freq change 212400H Main 47.35 alt 59.40	Bdry clearence will be requested AM 22 Jul 71		

CONFIDENTIAL

CONFIDENTIAL

4 RAR/NZ (ANZAC) BN PATROL FORECAST FOR PERIOD 18 JUL 71 TO 25 JUL 71

Ptl Serial Number	17/71	18/71	
Sub Unit to provide	Adm Coy 4 RAR/NZ	Sp Coy 4 RAR/NZ	
Callsign-Frequency	74 Bn CP	73 Bn CP	
Controlled by	4 RAR/NZ (ANZAC) Bn		
Task (Cont)	Day 18 Jul Recce GS 3764	Ni 20/21 Jul Ambush	
	Ni 18/19 Jul Ambush	G 412691	
	G 373645	Day 21 Jul S/Patrol	
	Day 19 Jul S/Patrol	G385695	
	G 375655	Ni 21/22 Jul Ambush	
	Ni 19/20 Jul Ambush	G 382693	
	G 380643	Day 22 Jul S/Patrol	
		G 385695	
		Ni 22/23 Jul Ambush	
		G 386699	
		Day 23 Jul S/Patrol	
		G 391703	
		Ni 23/24 Jul Ambush 397699	
		Day 24 Jul S/Ptl 404702	
	Ni 24/25 Jul Ambush 411702		
Strength	1 x 10	1 x 10	
Route Out	Drop Off G 418675	Drop Off G 420679	
Route In	Pick Up G 382628	Pick Up G 423685	
Date/Time Out	151600H	201630H	
Date/Time In	200800H	250730H	
Remarks	Tpt 1 x TCV 4 RAR/NZ 1 x Escort Adm Coy	Tpt - 1 x TCV 4 RAR/NZ Plus 1 x Escort Patrol Comd for briefing to RSM 190930H	



CONFIDENTIAL

AUSTRALIAN ARMY

R617/1/4

Headquarters  
1st Australian Task Force  
NUI DAT

21 Jul 71

Distribution below.

1 ATF PATROL PROGRAMME AMENDMENT NO 1

1. Attached is an amended patrol programme for 4 RAR/NZ (ANZAC) for the period 18 - 25 Jul 71.

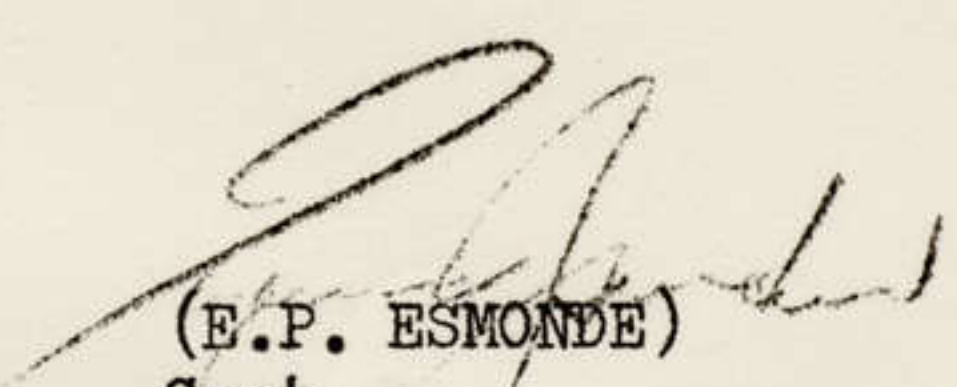
  
(E.P. ESMONDE)  
Capt  
GS03 (Ops)

Distribution:

C Sqn 1 Armd Regt	(3)
A Sqn 3 Cav Regt	(2)
12 Fd Regt	(9)
1 Fd Sqn RAE	(3)
21 Engr Tp	(2)
17 Const Sqn	(2)
104 Sig Sqn	
547 Sig Sqn	
4 RAR/NZ (ANZAC)	(13)
3 RAR	(11)
2 SAS Sqn	
1 ARU	(10)
161 (Indep) Recce Flt	
TFMA	(3)
HQ Coy 1 ATF	
106 Fd Wksp	
1 ATF CP	
GS02 (Ops)	
GS03 (Ops)	
GS03 (SD and Trg)	
ATOC	
LO DUC THANH	
LO LONG LE	
File	
Float	
Diary	(2)
Spares	(5)

CONFIDENTIAL

CONFIDENTIAL

AMENDMENT

4 RAR/NZ(ANZAC) BN PATROL FORECAST FOR PERIOD 18 JUL TO 25 JUL 71

Ptl Serial Number	18/71	19/71
Sub Unit to provide	Sp Coy 4 RAR/NZ(ANZAC)	Admin Coy 4 RAR/NZ(ANZAC) Bn
Callsign - Frequency	73 Bn CP	72 Bn CP
Controlled by	4 RAR/NZ(ANZAC) Bn	4 RAR/NZ(ANZAC) Bn
Task	Cancelled	Ni 22/23 Jul Ambush Grid 414685
		Day 23 Jul Standing Patrol Grid 404687
		Ni 23/24 Jul Ambush Grid 398691
		Day 24 Jul Standing Patrol Grid 398700
		Ni 24/26 Jul Ambush Grid 395702
		Day 25 Jul Standing Patrol Grid 405702
		Ni 25/26 Jul Ambush Grid 411702
Strength		1 & 10
Route Out		Drop Off Grid 419679
Route In		Pick up Grid 420680
Date/Time Out		221630H
Date/Time In		260815H
Remarks		Tpt - 1 x TCV 4 RAR/NZ(ANZAC) Bn plus 1 x escort Admin Coy Patrol Comd for briefing to RSM 4 RAR/NZ(ANZAC) Bn 210930H.

CONFIDENTIAL

8

CONFIDENTIAL

AUSTRALIAN ARMY

Headquarters  
1st Australian Task Force  
NUI DAT

R617/1/4

22 Jul 71

Distribution Below

1 ATF PATROL PROGRAMME

1. Attached is the 1 ATF patrol programme from 250800 July 71 to 010800 Aug 71.

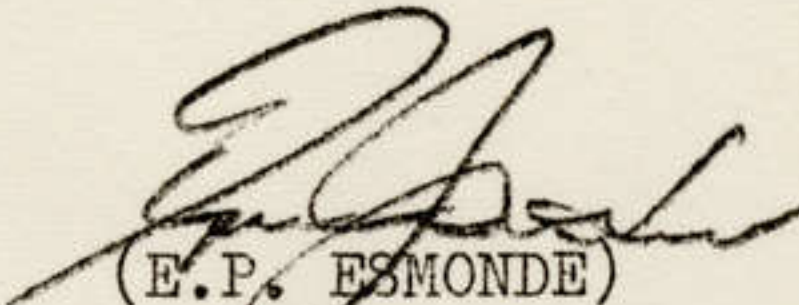
  
(E.P. ESMONDE)  
Capt  
GS03 (Ops)

Distribution:

C sqn 1 Armd Regt	(3)
A sqn 3 Cav Regt	(2)
12 Fd Regt	(9)
1 Fd sqn RAE	(3)
21 Engr Tp	(2)
17 Const sqn	(2)
104 Sig sqn	
547 Sig sqn	
4 RAR/NZ(ANZAC)	(13)
3 RAR	(11)
2 SAS sqn	
1 ARU	(10)
161 (Indep) Recce Flt	
TFMA	(3)
HQ Coy 1 ATF	
106 Fd Wksp	
1 ATF CP	
GS02 (Ops)	
GS03 (Ops)	
GS03 (SD and Trg)	
ATOC	
LO DUC THANH	
LO LONG LE	
File	
Float	
Diary	(2)
Spares	(5)

CONFIDENTIAL

CONFIDENTIAL

3 RAR PATROL FORECAST FOR PERIOD 26 JUL 71 TO 1 AUG 71

Ptl Serial Number	5/71	6/71		
sub unit to provide	Admin Coy 3 RAR	Admin Coy 3 RAR		
Callsign - Frequency	98A 64.55	98B 64.55		
Controlled by	3 RAR Base Def CP	3 RAR Base Def CP		
Task	N 26/27 Ambush	N 29/30 Ambush		
	Vic Grid 444688	Vic Grid 457718		
Strength	NCO and 7	NCO and 7		
Route Out	Direct	Direct		
Route In	Direct	Direct		
Date/Time Out	261815	291815		
Date/Time In	270700	300700		
Remarks		Tpt from 3 RAR Tpt compound to Rd Junction 447421. Pick up and RTU 300700.		

CONFIDENTIAL

AMENDMENT

4 RAR/NZ(ANZAC) BN PATROL FORECAST FOR PERIOD 25 JUL TO 31 JUL 71

Ptl Serial Number	19/71	20/71
Sub Unit to Provide	Admin Coy 4 RAR/NZ	Admin Coy 4 RAR/NZ(ANZAC) Bn
Callsign - Frequency	72                      Bn CP	72                      Bn CP
Controlled by	4 RAR/NZ(ANZAC) Bn	4 RAR/NZ(ANZAC) Bn
Task	Cancelled	Ni 23/24 Jul Ambush Grid 398669
		Day 24 Jul Standing Patrol Grid 396676
		Ni 24/25 Jul Ambush Grid 390673
		Day 25 Jul Standing Patrol Grid 396685
		Ni 25/26 Jul Ambush Grid 393684
Strength		1 & 10
Route Out		Drop Off Grid 420670
Route In		Pick Up Grid 419678
Date/Time Out		231700H
Date/Time In		260900H
Remarks		Tpt - 1 x TCV 4 RAR/NZ 1 x escort Admin Coy Patrol Comd for brief to RSM 221330H.

CONFIDENTIAL

CONFIDENTIAL

2 SAS SQN PATROL FORECAST F R PERIOD 25 JUL TO 01 AUG 71

A. Ptl Ser No	T/213	T/214	T/215	T/216
B. Sub Unit	2 SAS SQN	1 Fd Sqn	17 Const Sqn	2 SAS SQN
C. C/S and Freq	59 Freq at Sig Brief	59 Freq at Sig Brief	59 Freq at Sig Brief	59 Freq at Sig Brief
D. Controlled By	2 SAS SQN C/S 21	2 SAS SQN C/S 21	2 SAS SQN C/S 21	2 SAS SQN C/S 21
E. Task	Sector 9 Standing Ptl YS 432680	Sector 9 Standing Ptl YS 433679	Sector 9 Standing Ptl YS 432677	Sector 9 Standing Ptl YS 433679
F. Strength	1 : 5	1 : 5	1 : 5	1 : 5
G. Date Time Insertion	251930H Jul 71	261930H Jul 71	271930H Jul 71	281930H Jul 71
H. Date Time Extraction	260700H Jul 71	270700H Jul 71	280700H Jul 71	290700H Jul 71
I. Route Out	As per brief	As per brief	As per brief	As per brief
J. Route In	See Note (1)	As per brief	As per brief	As per brief
K. Remarks	Ptl Comd and Sig brief 2 SAS SQN 250900H Jul 71	Ptl Comd and Sig brief 2 SAS SQN 260900H Jul 71	Ptl Comd and Sig brief 2 SAS SQN 270900H Jul 71	Ptl Comd and Sig brief 2 SAS SQN 280900H Jul 71

A. T/217	T/218	T/219
B. 1 Fd Sqn	17 Const Sqn	2 SAS Sqn
C. 59 Freq at Sig brief	59 Freq at Sig brief	59 Freq at Sig brief
D. 2 SAS SQN C/S 21	2 SAS SQN C/S 21	2 SAS SQN C/S 21
E. Sector 9 Standing Ptl YS 432677	Sector 9 Standing Ptl YS 432680	Sector 9 Standing Ptl YS 433679
F. 1 : 5	1 : 5	1 : 5
G. 291930H Jul 71	301930H Jul 71	311930H Jul 71
H. 300700H Jul 71	310700H Jul 71	010700H Aug 71
I. As per brief	As per brief	As per brief
J. As per brief	See Note (1)	As per brief
K. Ptl Comd and Sig brief 2 SAS SQN 290900H Jul 71	Ptl Comd and Sig brief 2 SAS SQN 300900H Jul 71	Ptl Comd and Sig brief 2 SAS SQN 310900H Jul 71

Note (1)

Sweep NORTH creek to EASTERN perimeter fence then NORTH to wire on SOUTHERN side of LUSCOMBE then EAST to ROUTE 2 then SOUTH to RV.

CONFIDENTIAL  
1 ARU PATROL TASK TABLE  
FOR PERIOD FROM 250800H TO 010800H JUL/AUG 71

	207/71	208/71	209/71
A Serial No			
B Sub unit to provide	3 Platoon	3 Platoon	3 Platoon
C Call sign and frequency	56 - 47.35 alt 59.40	56 - 47.35 alt 59.40	56 - 47.35 alt 59.40
D Controlled by	1 ARU	1 ARU	1 ARU
E Task	Standing Ptl AO LUGARNO ni loc vic 435647	Standing ptl AO LUGARNO ni loc vic 452634	Standing Ptl AO LURGANO ni loc vic 445644
F Strength	1:8	1:8	1:8
G Date/time out	251500H	261500H	271500H
H Date/time In	260800H	270800H	280800H
J Route	Direct	Direct	Direct
K Remarks	Bdry clearence will be requested AM 25 Jul 71	Bdry clearence will be requested AM 26 Jul 71	

	210/71	211/71	212/71	213/71
A				
B	2 Platoon	3 Platoon	2 Platoon	3 Platoon/1
C	52 - 47.35 alt 59.40	56 - 47.35 alt 59.40	52 - 47.35 alt 59.40	56 - 47.35 alt 59.40
D	1 ARU	1 ARU	1 ARU	1 ARU
E	Fighting Ptl AO LUGARNO ni loc vic 436639	Standing Ptl AO LUGARNO ni loc vic 450647	Fighting Ptl AO LUGARNO ni loc vic 441630	Standing Ptl AO LUGARNO ni loc vic 446639
F	1:30	1:8	1:30	1:8
G	281000H	291500H	301500H	311500H
H	290800H	300800H	310800H	010800
J	Direct	Direct	Direct	Direct
K	Bdry clearence will be requested AM 28 Jul 71	Bdry clearence will be requested AM 29 Jul 71	Bdry clearence will be requested AM 30 Jul 71	Freq change 312400H Freq to be advised.

CONFIDENTIAL

AUSTRALIAN ARMY

R617/1/4

Headquarters  
1st Australian Task Force  
NUI DAT

Distribution below:

29 Jul 71

1 ATF PATROL PROGRAMME

1. Attached is the 1 ATF patrol programme for the period 010800H Aug 71 to 080800H Aug 71.

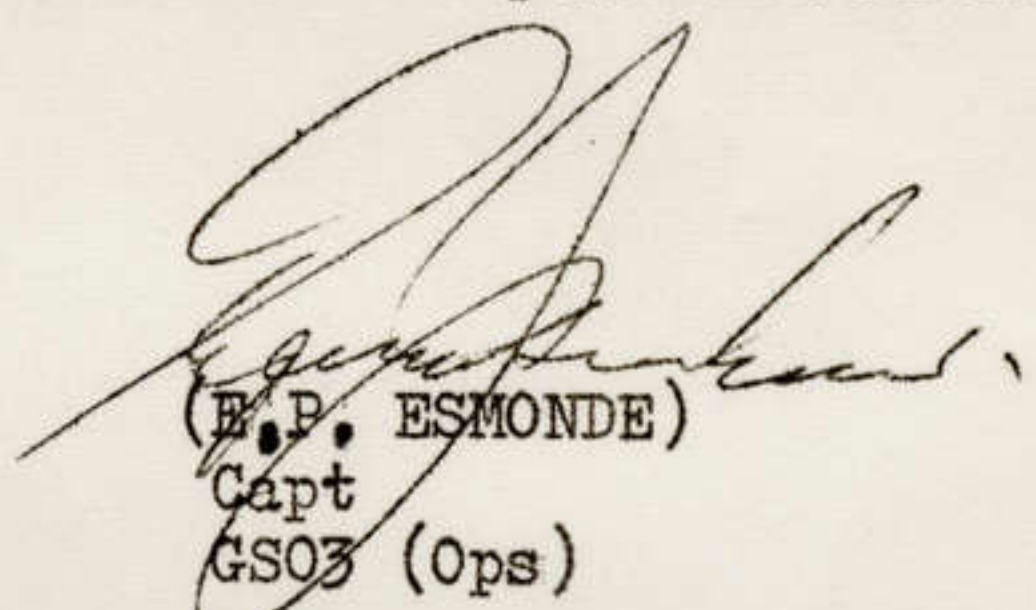
  
(E.P. ESMONDE)  
Capt  
GS03 (Ops)

Distribution:

C Sqn 1 Armd Regt	(3)
A Sqn 3 Cav Regt	(2)
12 Fd Regt	(9)
1 Fd Sqn RAE	(3)
21 Engr Tp	(2)
17 Const Sqn	(2)
104 Sig Sqn	
547 Sig Sqn	
4 RAR/NZ (ANZAC)	(13)
3 RAR	(11)
2 SAS Sqn	
1 ARU	(10)
161 (Indep) Recce Flt	
TFMA	(3)
HQ Coy 1 ATF	
106 Fd Wksp	
1 ATF CP	
GS02 (Ops)	
GS03 (Ops)	
GS03 (SD and Trg)	
ATOC	
LO DUC THANH	
LO LONG LE	
File	
Float	
Diary	(2)
Spares	(5)

CONFIDENTIAL



CONFIDENTIAL

4 RAR/NZ(ANZAC) BN PATROL FORECAST FOR PERIOD 30 JUL TO 7 AUG 71

Ptl Serial Number	22/71	23/71		
Sub Unit to provide	Admin Coy 4 RAR/NZ	104 Sig Sqn		
Callsign-Frequency	71 Bn CP	73 Bn CP		
Controlled by	4 RAR/NZ(ANZAC) BN			
Task	Ni 30/31 Jul Ambush G 375636	G 374645 Day 03 Aug S/Patrol	Ni 05/06 Aug Ambush G 414685	
	Day 31 Jul Standing Patrol G 370644	G 370644 Ni 03/04 Aug Ambush	Day 06 Aug S/Patrol G 400701	
	Ni 31 Jul-1 Aug Ambush G 366643	G 379644 Day 04 Aug S/Patrol	Ni 06/07 Aug Ambush G 394703	
	Day 1 Aug S/Patrol G 370644	G 375645 Ni 04/05 Aug Ambush	Day 07 Aug S/Patrol G 392704	
	Ni 01/02 Aug Ambush G 366647	G 380642		
	Day 02 Aug S/Patrol G 370644			
	Ni 02/03 Aug Ambush			
	Strength		1x9	1x9
	Route Out		Drop off G 382629	Drop off G 420670
	Route In		Pick up G 383628	Pick up G 424684
	Date/Time Out		30 1800	05 1700
	Date/Time In		05 0800	10 0830
Rmarks		Tpt - 1xTCV 4 RAR/NZ 1 x escort Adm Coy Patrol Comd to RSM for briefing 290930	Tpt - 104 Sig Sqn Patrol Comd to RSM 4 RAR/NZ for briefing 040930	

CONFIDENTIAL  
1 ARU PATROL TASK TABLE  
FOR PERIOD FROM 010800H TO 080800H AUG 71

A	Serial No	214/71	215/71	216/71
B	Subunit to provide			
C	Call sign and frequency			
D	Controlled by			
E	Task	No Patrol	No Patrol	No Patrol
F	Strength			
G	Date/Time out	1 Aug 71	2 Aug 71	3 Aug 71
H	Date/Time in			
J	Route			
K	Remarks			
A	217/71	218/71	219/71	220/71
B	1 Platoon		1 Platoon	
C	51 - 45.05 alt 71.35		51 - 45.05 alt 71.35	
D	1 ARU		1 ARU	
E	Fighting Ptl AO PADDINGTON ni loc vic 452633	No Patrol	Fighting Ptl AO PADDINGTON ni loc vic 442630	No Patrol
F	1:30		1:30	
G	041500H	5 Aug 71	061800H	7 Aug 71
H	050800H		070800H	
J	Direct		Direct	
K	Bdry clearence will be requested AM 4 Aug 71		Bdry clearence will be requested AM 6 Aug 71	

CONFIDENTIAL

2 SAS SQN PATROL FORECAST FOR PERIOD 01AUG TO 07 AUG 71

A. Ptl Ser No	T/220	T/221	T/222	T/223
B. Sub Unit	1 Fd Sqn	17 Const Sqn	2 SAS SQN	1 Fd Sqn
C. C/S and Freq	59 Freq at Sig Brief	59 Freq at Sig Brief	59 Freq at Sig Brief	59 Freq at Sig Brief
D. Controlled By	2 SAS SQN C/S 21	2 SAS SQN C/S 21	2 SAS SQN C/S 21	2 SAS SQN C/S 21
E. Task	Sector 9 Standing Ptl YS 432677	Sector 9 Standing Ptl YS 432680	Sector 9 Standing Ptl YS 432677	Sector 9 Standing Ptl YS 433679
F. Strength	1 : 5	1 : 5	1 : 5	1 : 5
G. Date Time Insertion	011930 Aug 71	021930H Aug 71	031930H Aug 71	041930H Aug 71
H. Date Time Extraction	020700H Aug 71	030700H Aug 71	040700H Aug 71	050700H Aug 71
I. Route Out	As per brief	As per brief	As per brief	As per brief
J. Route In	As per brief	See Note (1)	As per brief	As per brief
K. Remarks	Ptl Comd and Sig brief 2 SAS SQN 010900H Aug 71	Ptl Comd and Sig brief 2 SAS SQN 020900H Aug 71	Ptl Comd and Sig brief 2 SAS SQN 030900H Aug 71	Ptl Comd and Sig brief 2 SAS SQN 040900H Aug 71

A. T/224	T/225	T/226
B. 17 Const Sqn	2 SAS SQN	1 Fd Sqn
C. 59 Freq at Sig Brief	59 Freq at Sig Brief	59 Freq at Sig Brief
D. 2 SAS SQN C/S 21	2 SAS SQN C/S 21	2 SAS SQN C/S 21
E. Sector 9 Standing Ptl YS 433679	Sector 9 Standing Ptl YS 432680	Sector 9 Standing Ptl YS 432677
F. 1 : 5	1 : 5	1 : 5
G. 051930H Aug 71	061930H Aug 71	071930H Aug 71
H. 060700H Aug 71	070700H Aug 71	080700H Aug 71
I. As per brief	As per brief	As per brief
J. As per brief	See Note (1)	As per brief
K. Ptl Comd and Sig brief 2 SAS SQN 050900H Aug 71	Ptl Comd and Sig brief 2 SAS SQN 060900H Aug 71	Ptl Comd and Sig brief 2 SAS SQN 070900H Aug 71

Note (1)

Sweep NORTH creek to WESTERN perimeter fence then NORTH to wire on SOUTHERN side of LUSCOMBE then EAST to ROUTE 2 then SOUTH to RV.

MESSAGE FORM

10

PRIORITY PRIORITY 011030 Z JUL 71 R569/1/82  
FROM : 1 ATF CONFIDENTIAL  
TO : CG ~~CG~~ TRAC CG RTAVF 1 ATF LO RTAVF 1 ATF LO XUAN LOC OPS1155  
1 ATF LO 3 BDE 1ST (US) CAV DIV (AM)  
INFO : AUSTFORCE VIETNAM ~~COMP~~ ~~COMP~~ ~~SOZ (OPS)~~ ~~SOZ (OPS)~~  
ATTN : G3 (OPS) PLANS SUMMARY FOR PERIOD 030001H TO 032400H JUL 71 .  
ONE : 1 ATF HQ NUI DAT .  
TWO : C SQN 1 ARMD REGT . SQN HQ CMM 1 TP NUI DAT . 2 TP NUI DAT CEASED OPS PREPARE  
FOR RTA . 3 TP NUI DAT 1 ATF RRF . 5 TP FSB MARY OP CON 12 FD REGT . FWD DEL  
TP FSB MAUREEN OP CON 12 FD REGT .  
THREE : A SQN 3 CAV REGT . SQN HQ NUI DAT . TP NUI DAT 1 ATF RRF . TP AO BIRDSVILLE  
OP CON 4 RAR/NZ(ANZAC) . TP AO GLENELG OP CON 3 RAR . ELMS FSB MARY CMM  
NDP SUSAN CMM AO GLENELG AND NDP DIANNE .  
FOUR : 1 ATF ARTILLERY . REGT HQ NUI DAT . A FD BTY SECT NUI DAT CMM SECT FSB  
ZIGGIE . 104 FD BTY SECT FSB MARY CMM SECT FSB MAUREEN . C BTY (-) 5/42 (US)  
ARTY NUI DAT .  
FIVE : 1 FD SQN . SQN HQ NUI DAT . ELMS CONTINUE TO SP C SQN 1 ARMD REGT CMM A SQN 3  
CAV REGT AND BOTH INF BNS . LCT NDP DIANNE . MCT NUI DAT . ROAD RECONSTRUCTION  
EAST OF BINH GIA (ROUTE 327) CONTINUES . CONSTRUCTION OF WATER POINT AT NDP  
HORSESHOE CONTINUES .  
SIX : 17 CONST SQN . SQN HQ NUI DAT . RF HOUSING CMM CURB AND GUTTERING BARIA  
CONTINUES . QUARRY OPS CONTINUE NUI DAT . BRIDGE CONSTRUCTION TEAM NDP  
SUSAN WORKING ON BRIDGE 6 . WELL BORING AN NHUT CONTINUES . CONST ROUTE 2  
CONTINUES .  
SEVEN : 3 RAR . BN HQ FSB ZIGGIE . A COY NUI DAT CMM 1 ATF RRF . B COY CMM C COY CMM  
D COY AO GLENELG . SP COY (-) FSB ZIGGIE .  
EIGHT : 4 RAR/NZ(ANZAC) . BN HQ COURTENAY HILL . V COY CMM B COY CMM C COY AND D  
COY AO BIRDSVILLE . SP COY (-) COURTENAY HILL .  
NINE : 1 ARU . 1 PL CMM 2 PL AND 3 PL NUI DAT .  
TEN : D AND E PL NUI DAT .  
ELEVEN : 2 SAS SQN HAS 4 LRRPS DEPLOYED

PAGE ONE OF ONE PAGES CLASSIFIED YES

HILL

DUTY OFFICER

EBONY CP

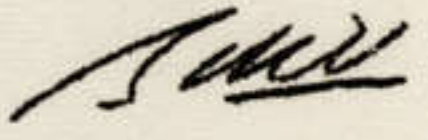
  
CAPT

MESSAGE FORM

//

PRIORITY PRIORITY

02 1030 Z JUL 71

R569/1 /82

FROM : 1 ATF

CONFIDENTIAL

TO : CG TRAC CG RTAVF 1 ATF LO RTAVF 1 ATF LO XUAN LOC  
1 ATF LO 3 BDE 1ST (US) CAV DIV (AM)

OPS 1159

INFO : AUSTFORCE VIETNAM ~~COMP D COMP~~ ~~ASSOZ (OPS)~~ ~~ASSOZ (OPS)~~

ATTN : G3 (OPS) PLANS SUMMARY FOR PERIOD 040001H TO 042400H JUL 71 .

ONE : 1 ATF HQ NUI DAT .

TWO : C SQN 1 ARMD REGT . SQN HQ CMM 1 TP NUI DAT . 3 TP NUI DAT 1 ATF RRF . 5 TP  
FSB MARY OP CON 12 FD REGT . FWD DEL TP FSB MAUREEN OP CON 12 FD REGT .

THREE : A SQN 3 CAV REGT . SQN HQ NUI DAT . TP NUI DAT 1 ATF RRF . TP AO BIRDSVILLE  
OP CON 4 RAR/NZ(ANZAC) . TP AO GLENELG OP CON 3 RAR . ELMS FSB MARY CMM NDP SUSAN  
CMM AO GLENELG AND NDP DIANNE .

FOUR : 1 ATF ARTILLERY . REGT HQ NUI DAT . A FD BTY SECT NUI DAT CMM SECT FSB ZIGGIE .  
104 FD BTY SECT FSB MARY CMM SECT FSB MAUREEN . C BTY (-) 5/42 (US) ARTY NUI DAT .

FIVE : 1 FD SQN . SQN HQ NUI DAT . ELMS CONTINUE SP C SQN 1 ARMD REGT CMM A SQN 3 CAV REGT  
AND BOTH INF BNS . LCT NDP DIANNE . MCT NUI DAT . ROAD RECONSTRUCTION EAST OF BINH  
GIA (ROUTE 327) CONTINUES .

SIX : 17 CONST . SQN HQ NUI DAT . RF HOUSING CMM CURB AND GUTTERING BARIA CONTINUES .  
QUARRY OPS CONTINUE NUI DAT . BRIDGE CONSTRUCTION TEAM NDP SUSAN WORKING ON BRIDGE  
6 . WELL BORING AN NHUT CONTINUES . CONST ROUTE 2 NORTH AND SOUTH OF NUI DAT  
CONTINUES .

SEVEN : 3 RAR . BN HQ FSB ZIGGIE . A COY NUI DAT CMM 1 ATF RRF . B COY CMM C COY CMM D COY  
AO GLENELG . SP COY (-) FSB ZIGGIE .

EIGHT : 4 RAR/NZ(ANZAC) . BN HQ COURTENAY HILL . V COY CMM B COY AO BIRDSVILLE . C COY  
REDEPLOY TO NUI DAT CMM D COY AO BIRDSVILLE . SP COY (-) COURTENAY HILL .

NINE : 1 ARU . 1 PL CMM 2 PL AND 3 PL NUI DAT .

TEN : D AND E PL NUI-DAT .

ELEVEN : 2 SAS SQN HAS 6 LRRPS DEPLOYED

PAGE ONE OF ONE PAGES CLASSIFIED YES

ESMONDE GSO3 OPS

EBONY 10

*Smith*  
CAPT

MESSAGE FORM

12

PRIORITY PRIORITY 03 100Z JUL 71 R569/1/83  
 FROM : 1 ATF CONFIDENTIAL  
 TO : CG TRAC CG RTAVF 1 ATF LO RTAVF 1 ATF LO XUAN LOC OPS1167  
 1 ATF LO 3 BDE 1ST (US) CAV DIV (AM)  
 INFO : AUSTFORCE VIETNAM ~~COMP~~ ~~COMP~~ ~~GS02 (OPS)~~ ~~GS03 (OPS)~~  
 ATTN : G3 (OPS) PLANS SUMMARY FOR PERIOD 050001H TO 052400H JUL 71 .  
 ONE : 1 ATF HQ NUI DAT .  
 TWO : C SQN 1 ARMD REGT . SQN HQ CMM 1 TP NUI DAT . 3 TP NUI DAT 1 ATF RRF .  
 5 TP FSB MARY OP CON 12 FD REGT . FWD DEL TP FSB MAUREEN OP CON 12 FD REGT .  
 THREE : A SQN 3 CAV REGT . SQN HQ NUI DAT . TP NUI DAT 1 ATF RRF . TP AO BIRDSVILLE  
 OP CON 4 RAR/NZ(ANZAC) . TP AO GLENELG OP CON 3 RAR . ELMS FSB MARY CMM  
 NDP SUSAN CMM AO GLENELG AND NDP DIANNE .  
 FOUR : 1 ATF ARTILLERY . REGT HQ NUI DAT . A FD BTY SECT NUI DAT CMM SECT FSB ZIGGIE .  
 104 FD BTY SECT FSB MARY CMM SECT FSB MAUREEN . C BTY (-) 5/42(US) ARTY NUI  
 DAT .  
 FIVE : 1 FD SQN . SQN HQ NUI DAT . ELMS CONTINUE SP C SQN 1 ARMD REGT CMM A SQN  
 3 CAV REGT AND BOTH INF BNS . LCT NDP DIANNE . MCT DEPLOY TO AREA DINH CO  
 (YS 4457) . ROAD RECONSTRUCTION EAST OF BINH GIA (ROUTE 327) CONTINUES .  
 SIX : 17 CONST . SQN HQ NUI DAT . RF HOUSING CMM CURB AND GUTTERING BARIA CONTINUES .  
 QUARRY OPS CONTINUE NUI DAT . BRIDGE CONSTRUCTION TEAM NDP SUSAN WORKING ON  
 BRIDGE 6 . WELL BORING AN NHUT CONTINUES . CONST ROUTE 2 NORTH AND SOUTH  
 OF NUI DAT CONTINUES .  
 SEVEN : 3 RAR . BN HQ FSB ZIGGIE . A COY NUI DAT CMM 1 ATF RRF . B COY CMM C COY  
 CMM D COY AO GLENELG . SP COY (-) FSB ZIGGIE .  
 EIGHT : 4 RAR/NZ(ANZAC) . BN HQ COURTENAY HILL . V COY CMM B COY AO BIRDSVILLE .  
 C COY NUI DAT CMM D COY AO BIRDSVILLE . SP COY (-) COURTENAY HILL .  
 NINE : 1 ARU . 1 PL CMM 2 PL AND 3 PL NUI DAT .  
 TEN : D AND E PL NUI-DAT .  
 ELEVEN : 2 SAS SQN HAS 5 LRRPS DEPLOYED

PAGE ONE OF ONE PAGES

CLASSIFIED YES

ESMONDE

GS03 (OPS)

EBONY 10



CAPT

13

MESSAGE FORM

PRIORITY : PRIORITY 04100Z JUL 71 R569/1/83  
 FROM : 1 ATF CONFIDENTIAL  
 TO : CG TRAC CG RTAVF 1 ATF LO RTAVF 1 ATF LO OPS 1170  
 XUAN LOC 1 ATF LO 3 BDE 1ST (US) CAV DIV (AM)  
 INFO : AUSTFORCE VIETNAM ~~COMD~~ ~~1~~ ~~COMD~~ ~~AS02/(OPS)~~ ~~AS03/(OPS)~~  
 ATTN : G3 (OPS) PLANS SUMMARY FOR PERIOD 060001H TO 062400H JUL 71 .  
 ONE : 1 ATF HQ NUI DAT .  
 TWO : C SQN 1 ARMD REGT . SQN HQ CMM TP NUI DAT . TP NUI DAT 1 ATF PRF .  
 TP FSB MARY OP CON 12 FD REGT . TP FSB MAUREEN OP CON 12 FD REGT .  
 THREE : A SQN 3 CAV REGT . SQN HQ NUI DAT . TP NUI DAT 1 ATF RRF . TP AO  
 BIRDSVILLE OP CON 4 RAR/NZ (ANZAC) . TP AO GLENELG OP CON 3 RAR . ELMS  
 FSB MARY CMM NDP SUSAN CMM AO GLENELG AND NDP DIANNE .  
 FOUR : 1 ATF ARTILLERY . REGT HQ NUI DAT . A FD BTY SECT NUI DAT CMM SECT  
 FSB ZIGGIE . 104 FD BTY SECT FSB MARY CMM SECT FSB MAUREEN . C BTY (-)  
 5/42 (US) ARTY NUI DAT .  
 FIVE : 1 FD SQN . SQN HQ NUI DAT . ELMS CONTINUE SP C SQN 1 ARMD REGT CMM  
 A SQN 3 CAV REGT AND BOTH INF BNS . LCT NDP DIANNE . MCT AREA DINH CO  
 (YS 4457) . ROAD RECONSTRUCTION EAST OF BINH GIA (ROUTE 327) CONTINUES .  
 SIX : 17 CONST . SQN HQ NUI DAT . RF HOUSING CMM CURB AND GUTTERING BARIA  
 CONTINUES . QUARRY OPS CONTINUE NUI DAT . BRIDGE CONSTRUCTION TEAM  
 NDP SUSAN WORKING ON BRIDGE 6 . WELL BORING AN NHUT CONTINUES . CONST  
 ROUTE 2 NORTH AND SOUTH OF NUI DAT CONTINUES .  
 SEVEN : 3 RAR . BN HQ FSB ZIGGIE . A COY NUI DAT CMM 1 ATF RRF . B COY CMM  
 C COY CMM D COY AO GLENELG . SP COY (-) FSB ZIGGIE .  
 EIGHT : 4 RAR/NZ (ANZAC) . BN HQ COURTENAY HILL . V COY CMM B COY AO BIRDSVILLE .  
 C COY NUI DAT CMM D COY AO BIRDSVILLE . SP COY (-) COURTENAY HILL .  
 NINE : 1 ARU . 1 PL CMM 2 PL AND 3 PL NUI DAT .  
 TEN : D AND E PL NUI DAT .  
 ELEVEN : 2 SAS SQN 7 LRRPS DEPLOYED

PAGE 1 OF 1 PAGES CLASSIFIED YES ESMONDE GS03 (OPS) EBONY 10

*[Handwritten Signature]*  
 CAPT

14

MESSAGE FORM

PRIORITY PRIORITY 05 1130 Z JUL 71 569-1-82  
 FROM : 1 ATF CONFIDENTIAL  
 TO : CG TRAC CG RTAVF 1 ATF LO RTAVF 1 ATF LO XUAN LOC OPS 1178  
 1 ATF LO 3 BDE 1ST (US) CAV DIV (AM)  
 INFO : AUSTFORCE VIETNAM ~~COMP~~ ~~B/COMP~~ ~~GSO2 (OPS)~~ ~~GSO3 (OPS)~~  
 ATTN : G3 (OPS) PLANS SUMMARY FOR PERIOD 070001H TO 072400H JUL 71 .  
 ONE : 1 ATF HQ NUI DAT .  
 TWO : C SQN 1 ARMD REGT . SQN HQ CMM TP NUI DAT . TP NUI DAT 1 ATF RRF .  
 TP FSB MARY OP CON 12 FD REGT . TP FSB MAUREEN OP CON 12 FD REGT .  
 THREE : A SQN 3 CAV REGT . SQN HQ NUI DAT . TP NUI DAT 1 ATF RRF . TP AO  
 BIRDSVILLE OP CON 4 RAR/NZ(ANZAC) . TP AO GLENELG OP CON 3 RAR . ELMS  
 FSB MARY CMM NDP SUSAN CMM AO GLENELG AND NDP DIANNE .  
 FOUR : 1 ATF ARTILLERY . REGT HQ NUI DAT . A FD BTY SECT NUI DAT CMM SECT  
 FSB ZIGGIE . 104 FD BTY SECT FSB MARY CMM SECT FSB MAUREEN . C BTY (-)  
 5/42 (US) ARTY NUI DAT .  
 FIVE : 1 FD SQN . SQN HQ NUI DAT . ELMS CONTINUE SP C SQN 1 ARMD REGT CMM  
 A SQN 3 CAV REGT AND BOTH INF BNS . LCT NDP DIANNE . MCT AREA DINH CO  
 (YS 4457) . ROAD RECONSTRUCTION EAST OF BINH GIA (ROUTE 327) CONTINUES .  
 SIX : 17 CONST . SQN HQ NUI DAT . RF HOUSING CMM CURB AND GUTTERING BARIA  
 CONTINUES . QUARRY OPS CONTINUE NUI DAT . BRIDGE CONSTRUCTION TEAM  
 NDP SUSAN WORKING ON BRIDGE 6 . WELL BORING AN NHUT CONTINUES . CONST  
 ROUTE 2 NORTH AND SOUTH OF NUI DAT CONTINUES .  
 SEVEN : 3 RAR . BN HQ FSB ZIGGIE . A COY DEPLOYED TO AO GLENELG . B COY REDEPLOY  
 TO NUI DAT 1 ATF RRF . C COY CMM D COY AO GLENELG . SP COY (-) FSB ZIGGIE .  
 EIGHT : 4 RAR/NZ(ANZAC) . BN HQ COURTENAY HILL . V COY CMM B COY AO BIRDSVILLE .  
 C COY NUI DAT CMM D COY AO BIRDSVILLE . SP COY (-) COURTENAY HILL .  
 NINE : 1 ARU . 1 PL CMM 2 PL AND 3 PL NUI DAT .  
 TEN : D AND E PL NUI DAT .  
 ELEVEN : 2 SAS SQN 6 LRRPS DEPLOYED

PAGE ONE OF ONE PAGES CLASSIFIED YES ESMONDE GSO3 (OPS) EBONY 10

*Matthews*  
 CAPT



15

MESSAGE FORM

PRIORITY PRIORITY

061130Z JUL 71

R569-1-82

FROM : 1 ATF

CONFIDENTIAL

TO : CG TRAC CG RTAVF 1 ATF LO RTAVF 1 ATF LO XUAN LOC

OPS 1181

1 ATF LO 3 BDE 1ST (US) CAV DIV (AM)

INFO : AUSTFORCE VIETNAM ~~COMP~~ ~~PL~~ ~~OPS~~ (~~OPS~~) ~~OPS~~ (~~OPS~~)

ATTN : G3 (OPS) PLANS SUMMARY FOR PERIOD 080001H TO 082400H JUL 71 .

ONE : 1 ATF HQ NUI DAT .

TWO : C SQN 1 ARMD REGT . SQN HQ CMM TP NUI DAT . TP NUI DAT 1 ATF RRF .

TP FSB MARY OP CON 12 FD REGT . TP FSB MAUREEN OP CON 12 FD REGT .

THREE : A SQN 3 CAV REGT . SQN HQ NUI DAT . TP NUI DAT 1 ATF RRF . TP AO BIRDSVILLE OP CON 4 RAR/NZ(ANZAC) . TP AO GLENELG OP CON 3 RAR . ELMS FSB MARY CMM NDP SUSAN CMM AO GLENELG AND NDP DIANNE .

FOUR : 1 ATF ARTILLERY . REGT HQ NUI DAT . A FD BTY SECT NUI DAT CMM SECT FSB ZIGGIE . 104 FD BTY SECT FSB MARY CMM SECT FSB MAUREEN . C BTY (-) 5/42 (US) ARTY NUI DAT .

FIVE : 1 FD SQN . SQN HQ NUI DAT . ELMS CONTINUE SP C SQN 1 ARMD REGT CMM A SQN 3 CAV REGT AND BOTH INF BNS . LCT NDP DIANNE . MCT AREA DINH CO (YS 4457) . ROAD RECONSTRUCTION EAST OF BINH GIA (ROUTE 327) CONTINUES .

SIX : 17 CONST . SQN HQ NUI DAT . RF HOUSING CMM CURB AND GUTTERING BARRIA CONTINUES . QUARRY OPS CONTINUE NUI DAT . BRIDGE CONSTRUCTION TEAM NDP SUSAN WORKING ON BRIDGE 6 . WELL BORING AN NHUT CONTINUES . CONST ROUTE 2 NORTH AND SOUTH OF NUI DAT CONTINUES .

SEVEN : 3 RAR . BN HQ FSB ZIGGIE . A COY AO GLENELG . B COY NUI DAT 1 ATF RRF . C COY CMM D COY AO GLENELG . SP COY (-) FSB ZIGGIE .

EIGHT : 4 RAR/NZ(ANZAC) . BN HQ COURTENAY HILL . V COY CMM B COY AO BIRDSVILLE . C COY NUI DAT CMM D COY AO BIRDSVILLE . SP COY (-) COURTENAY HILL .

NINE : 1 ARU . 1 PL CMM 2 PL AND 3 PL NUI DAT .

TEN : D AND E PL NUI DAT .

ELEVEN : 2 SAS SQN HAS 7 LRRPS DEPLOYED .

PAGE 1 OF 1 PAGES

CLASSIFIED YES

ESMONDE GS03 (OPS)

EBONY 10

*W. Mathews*  
CAPT

16

MESSAGE FORM

PRIORITY PRIORITY 07 1140 Z JUL 71 R569/1/82  
 FROM : 1 ATF  
 TO : CG TRAC CG RTAVF 1 ATF LO RTAVF 1 ATF LO XUAN LOC  
 1 ATF LO 3 BDE 1ST (US) CAV DIV (AM) OPS1185  
 INFO : AUSTFORCE VIETNAM ~~COMP~~ ~~COMP~~ ~~SOZ (OPS)~~ ~~SOZ (OPS)~~  
 ATTN : G3 (OPS) PLANS SUMMARY FOR PERIOD 090001H TO 092400H JUL 71 .  
 ONE : 1 ATF HQ NUI DAT .  
 TWO : C SQN 1 ARMD REGT . SQN HQ CMM TP NUI DAT . TP NUI DAT 1 ATF RRF . TP FSB MARY  
 OP CON 12 FD REGT . TP FSB MAUREEN OP CON 12 FD REGT .  
 THREE : A SQN 3 CAV REGT . SQN HQ NUI DAT . TP NUI DAT 1 ATF RRF . TP AO BIRDSVILLE  
 OP CON 4 RAR/NZ(ANZAC) . TP AO GLENELG OP CON 3 RAR . ELMS FSB MARY CMM  
 NDP SUSAN CMM AO GLENELG AND NDP DIANNE .  
 FOUR : 1 ATF ARTILLERY . REGT HQ NUI DAT . A FD BTY SECT NUI DAT CMM SECT  
 FSB ZIGGIE . 104 FD BTY SECT FSB MARY CMM SECT FSB MAUREEN . C BTY (-) 5/42  
 (US) ARTY NUI DAT .  
 FIVE : 1 FD SQN . SQN HQ NUI DAT . ELMS CONTINUE TO SP C SQN 1 ARMD REGT CMM A SQN  
 3 CAV REGT AND BOTH INF BNS . LCT NDP DIANNE . MCT AREA DINH CO (YS4457) .  
 ROAD RECONSTRUCTION EAST OF BINH GIA (ROUTE 327) CONTINUES .  
 SIX : 17 CONST . SQN HQ NUI DAT . RF HOUSING CMM CURB AND GUTTERING BARIA CONTINUES .  
 QUARRY OPS CONTINUE NUI DAT . BRIDGE CONSTRUCTION TEAM NDP SUSAN WORKING ON  
 BRIDGE 6 . WELL BORING AN NHUT CONTINUES . CONST ROUTE 2 NORTH AND SOUTH OF  
 NUI DAT CONTINUES .  
 SEVEN : 3 RAR . BN HQ FSB ZIGGIE . A COY AO GLENELG . B COY NUI DAT 1 ATF RRF . C COY  
 CMM D COY AO GLENELG . SP COY (-) FSB ZIGGIE .  
 EIGHT : 4 RAR/NZ(ANZAC) . BN HQ COURTENAY HILL . V COY CMM B COY AO BIRDSVILLE .  
 C COY NUI DAT CMM D COY AO BIRDSVILLE . SP COY (-) COURTENAY HILL .  
 NINE : 1 ARU . 1 PL CMM 2 PL AND 3 PL NUI DAT .  
 TEN : D AND E PL NUI DAT .  
 ELEVEN : 2 SAS SQN HAS 6 LRRPS DEPLOYED

PAGE ONE OF ONE PAGES CLASSIFIED YES ESMONDE GS03 (OPS) EBONY 10  
*W. Mathus*  
 CAPT

MESSAGE FORM

17

PRIORITY

PRIORITY

081200Z JUL 71

R569/1/82

CONFIDENTIAL

OPS:194

FROM : 1 ATF

TO : CG TRAC CG RTAVF 1 ATF LO RTAVF 1 ATF LO XUAN LOC  
1 ATF LO 3 BDE 1ST (US) AIR CAV DIV (AM)

INFO : AUSTFORCE VIETNAM ~~COYD~~ ~~COYD~~ ~~CSØ2 (ØPØ)~~ ~~CSØ3 (ØPØ)~~

ATTN : G3 (OPS) . PLANS SUMMARY FOR PERIOD 100001H to 102400H JUL 71 .

ONE : 1 ATF HQ NUI DAT .

TWO : C SQN 1 ARMD REGT . SQN HQ CMM 2 TP NUI DAT . TP NUI DAT 1 ATF PRF !  
TP FSB MARY OP CON 12 FD REGT .

THREE : A SQN 3 CAV REGT . SQN HQ NUI DAT . TP NUI DAT 1 ATF RRF ! TP AO  
BIRDSVILLE OP CON 4 RAR/NZ(ANZAC) . TP AO GLENELG OP CON 3 RAR ! SP TP  
(FIRE SP VEHICLES) NDP DIANNE . ELMS FSB MARY CMM NDP SUSAN CMM AO  
GLENELG AND FSB MAUREEN !

FOUR : 1 ATF ARTILLERY . REGT HQ NUI DAT . A FD BTY SECT NUI DAT CMM SECT FSB  
ZIGGIE . 104 FD BTY SECT FSB MARY CMM SECT FSB MAUREEN . C BTY (-) 5/42  
(US) ARTY NUI DAT .

FIVE : 1 FD SQN . SQN HQ NUI DAT ! ELMS CONTINUE TO SP C SQN 1 ARMD REGT CMM  
A SQN 3 CAV REGT AND BOTH INF BNS . LCT DEPLOYS TO NDP CAROL (YS5571) .  
MCT AREA DINH CO (YS4457) ! ROAD RECONSTRUCTION EAST OF BINH GIA (ROUTE  
327) CONTINUES .

SIX : 17 CONST SQN . SQN HQ NUI DAT ! RF HOUSING CMM CURB AND GUTTERING BARIA  
CONTINUES . QUARRY OPS CONTINUE NUI DAT . BRIDGE CONSTRUCTION TEAM NDP  
SUSAN WORKING ON BRIDGE 6 . WELL BORING AN NHUT CONTINUES ! CONST ROUTE  
2 IN NORTH OF PROVINCE AND IN BARIA CONTINUES !

SEVEN : 3 RAR . BN HQ FSB ZIGGIE ! A COY AO GLENELG ! B COY NUI DAT 1 ATF RRF !  
C COY CMM D COY AO GLENELG ! SP COY (-) FSB ZIGGIE .

EIGHT : 4 RAR/NZ(ANZAC) . BN HQ COURTENAY HILL . V COY CMM B COY AO BIRDSVILLE .  
C COY NUI DAT . D COY AO BIRDSVILLE . SP COY (-) COURTENAY HILL !

NINE : 1 ARU . 1 PL CMM 2 PL AND 3 PL NUI DAT .

TEN : D AND E PL NUI DAT .

ELEVEN : 2 SAS SQN HAS 5 LRRPs DEPLOYED

PAGE ONE OF ONE PAGES CLASSIFIED YES ESMONDE GS03 (OPS) EBONY 10

*[Handwritten Signature]*  
CAPT

18

MESSAGE FORM

PRIORITY PRIORITY

09 Z JUL 71

R569/1/82

CONFIDENTIAL

OPS1198

**FROM** : 1 ATF

**TO** : CG TRAC CG RTAVF 1 ATF LO RTAVF 1 ATF LO XUAN LOC  
1 ATF LO 3 BDE 1ST (US) CAV DIV (AM)

**INFO** : AUSTFORCE VIETNAM ~~COMP~~ ~~COMP~~ ~~SOZ (OPS)~~ ~~SOZ (OPS)~~

**ATTN** : G3 (OPS) . PLANS SUMMARY FOR PERIOD 110001H TO 112400H JUL 71 .

**ONE** : 1 ATF HQ NUI DAT .

**TWO** : C SQN 1 ARMD REGT.. SQN HQ CMM TP NUI DAT . TP NUI DAT 1 ATF RRF . TP FSB MARY OP CON 12 FD REGT . FWD DEL TP NUI DAT .

**THREE** : A SQN 3 CAV REGT . SQN HQ NUI DAT . TP NUI DAT 1 ATF RRF . TP AO BIRDSVILLE OP CON 4 RAR/NZ(ANZAC) . TP AO GLENELG OP CON 3 RAR . SP TP (FIRE SP VEHICLES) NDP DIANNE . ELMS FSB MARY CMM NDP SUSAN CMM AO GLENELG AND FSB MAUREEN .

**FOUR** : 1 ATF ARTILLERY . REGT HQ NUI DAT . A FD BTY CLN SECT NUI DAT CMM SECT FSB ZIGGIE . 104 FD BTY CLN SECT FSB MARY CMM SECT FSB MAUREEN . C BTY (-) 5/42 (US) ARTY NUI DAT .

**FIVE** : 1 FD SQN . SQN HQ NUI DAT . ELMS CONTINUE TO SP C SQN 1 ARMD REGT CMM A SQN 3 CAV REGT AND BOTH INF BMS . LCT DEPLOYS NDP CAROL (YS5571) . MCT AREA DINH CO (YS4457) . ROAD RECONSTRUCTION EAST IF BINH GIA (ROUTE 327) CONTINUES .

**SIX** : 17 CONST SQN . SQN HQ NUI DAT . RF HOUSING CMM CURB AND GUTTERING BARIA CONTINUES QUARRY OPS CONTINUE NUI DAT . BRIDGE CONSTRUCTION TEAM NDP SUSAN WORKING ON BRIDGE 6 . WELL BORING NA NHUT CONTINUES . CONST ROUTE 2 IN NORTH OF PROVINCE AND IN BARIA CONTINUES .

**SEVEN** : 3 RAR . BN HQ FSB ZIGGIE . A COY AO GLENELG . B COY NUI DAT 1 ATF RRF . C COY REDEPLOYED TO NUI DAT 9 JUL . D COY AO GLENELG . SP COY (-) FSB ZIGGIE .

**EIGHT** : 4 RAR/NZ(ANZAC) . BN HQ COURTENAY HILL . V COY CMM B COY AO BIRDSVILLE . C COY NUI DAT . D COY AO BIRDSVILLE . SP COY (-) COURTENAY HILL .

**NINE** : 1 ARU . 4 PL CMM 2 PL AND 3 PL NUI DAT .

**TEN** : D AND E PL NUI DAT .

**ELEVEN** : 2 SAS SQN HAS 6 LRRPS DEPLOYED

PAGE ONE OF ONE PAGES

CLASSIFIED YES

ESMONDE GSO 3 (OPS)

EBONY 10

*M. Mathis*  
CAPT

MESSAGE FORM

10 1300Z JUL 71

R569/1/82

CONFIDENTIAL

OPS 1200

PRIORITY PRIORITY

FROM : 1 ATF

TO : CG TRAC CG RTAVF 1 ATF LO RTAVF 1 ATF LO XUAN LOC  
1 ATF LO 3 BDE 1ST (US) CAV DIV (AM)

INFO : AUSTFORCE VIETNAM ~~COMP~~ ~~COMP~~ ~~OPS~~ (OPS) ~~OPS~~ (OPS)

ATTN : G3 (OPS) . PLANS SUMMARY FOR PERIOD 120001H TO 122400H JUL 71 .

ONE : 1 ATF HQ NUI DAT .

TWO : C SQN 1 ARMD REGT . SQN HQ CMM TP NUI DAT . TP NUI DAT 1 ATF RRF . TP FSB MARY  
OP CON 12 FD REGT . FWD DEL TP NUI DAT .

THREE : A SQN 3 CAV REGT . SQN HQ NUI DAT . TP NUI DAT 1 ATF RRF . TP AO BIRDSVILLE OP  
OP CON 4 RAR/NZ(ANZAC) . TP AO GLENELG CP CON 3 RAR . SP TP NDP CAROL . ELMS FSB  
MARY CMM NDP SUSAN CMM AO GLENELG AND FSB MAUREEN .

FOUR : 1 ATF ARTILLERY . REGT HQ NUI DAT . A FD BTY CLN SECT NUI DAT CMM SECT FSB ZIGGIE .  
104 FD BTY CLN SECT FSB MARY CMM SECT FSB MAUREEN . C BTY (-) 5/42 (US) ARTY NUI  
DAT .

FIVE : 1 FD SQN . SQN HQ NUI DAT . ELMS CONTINUE TO SP C SQN 1 ARMD REGT CMM A SQN 3 CAV  
REGT AND BOTH INF BNS . LCT NDP CAROL (YS5571) . MCT AREA DINH CO (YS4457) . ROAD  
RECONSTRUCTION EAST OF BINH GIA (ROUTE 327) CONTINUES .

SIX : 17 CONST SQN . SQN HQ NUI DAT . RF HOUSING CMM CURB AND GUTTERING BARIA CONTINUES .  
QUARRY OPS CONTINUE NUI DAT . BRIDGE CONSTRUCTION TEAM NDP SUSAN WORKING ON BRIDGE  
6 . WELL BORING AN NHUT CONTINUES . CONST ROUTE 2 IN NORTH OF PROVINCE AND IN BARIA  
CONTINUES .

SEVEN : 3 RAR . BN HQ FSB ZIGGIE . A COY AO GLENELG . B COY NUI DAT . C COY NUI DAT . D COY  
AO GLENELG . SP COY (-) FSB ZIGGIE .

EIGHT : 4 RAR/NZ(ANZAC) . BN HQ COURTENAY HILL . V COY AND B COY AO BIRDSVILLE . C COY (-)  
DEPLOYS AO BIRDSVILLE CMM PL NUI DAT 1 ATF RRF . D COY AO BIRDSVILLE . SP COY (-)  
COURTENAY HILL .

NINE : 1 ARU . 1 PL CMM 2 PL AND 3 PL NUI DAT .

TEN : D AND E PL NUI DAT .

ELEVEN : 2 SAS SQN HAS SIX LRRPS DEPLOYED

PAGE ONE OF ONE PAGES CLASSIFIED YES ESMONDE GS03 (OPS) EBONY 10

*M. Matthews*  
CAPT

20

MESSAGE FORM

PRIORITY PRIORITY

11020 JUL 71

R569/1/82

CONFIDENTIAL

OPS 1203

FROM : 1 ATF

TO : CG TRAC CG RTAVF 1 ATF LO RTAVF 1 ATF LO XUAN LOC  
1 ATF LO 3 BDE 1ST (US) CAV DIV (AM)

INFO : AUSTFORCE VIETNAM ~~COMP~~ ~~COMP~~ ~~OPS~~ (~~OPS~~) ~~OPS~~ (~~OPS~~)

ATTN : G3 (OPS) . PLANS SUMMARY FOR PERIOD 130001H TO 132400H JUL 71 .

ONE : 1 ATF HQ NUI DAT .

TWO : C SQN 1 ARMD REGT 1 SQN HQ CMM TP NUI DAT . TP NUI DAT 1 ATF RRF . TP FSB MARY  
OP CON 12 FD REGT . FWD DEL TP NUI DAT .

THREE : A SQN 3 CAV REGT . SQN HQ NUI DAT . TP NUI DAT 1 ATF RRF . TP AO BIRDSVILLE  
OP CON 4 RAR/NZ(ANZAC) . TP AO GLENELG OP CON 3 RAR . SP TP NDP CAROL . ELMS  
FSB MARY CMM NDP SUSAN CMM AO GLENELG AND FSB MAUREEN .

FOUR : 1 ATF ARTILLERY . REGT HQ NUI DAT . A FD BTY CLN SECT NUI DAT CMM SECT FSB  
ZIGGIE . 104 FD BTY CLN SECT FSB MARY CMM SECT FSB MAUREEN . C BTY (-) 5/42 (US)  
ARTY NUI DAT .

FIVE : 1 FD SQN . SQN HQ NUI DAT . ELMS CONTINUE TP SP C SQN 1 ARMD REGT CMM A SQN 3  
CAV REGT AND BOTH INF BNS . LCT NDP CAROL (YS5571) . MCT NUI DAT . ROAD  
RECONSTRUCTION EAST OF BINH GIA (ROUTE 327) CONTINUES .

SIX : 17 CONST SQN . SQN HQ NUI DAT . RF HOUSING CMM ~~KERB~~ AND GUTTERING BARIA  
CONTINUES . QUARRY OPS CONTINUE NUI DAT . BRIDGE CONSTRUCTION TEAM NDP SUSAN  
WORKING ON BRIDGE 6 . WELL BORING AN NHUT CONTINUES . CONST ROUTE 2 IN NORTH  
OF PROVINCE AND BARIA CONTINUES .

SEVEN : 3 RAR . BN HQ FSB ZIGGIE A COY (-) FSB ZIGGIE CMM PTL TO THE EAST . B COY  
DEPLOYS TO AO GLENELG . C COY NUI DAT . D COY AO GLENELG . SP COY (-) AO GLENELG .

EIGHT : 4 RAR/NZ(ANZAC) . BN HQ COURTENAY HILL . V COY AND B COY AO BIRDSVILLE . C COY  
(-) AO BIRDSVILLE CMM PL NUI DAT 1 ATF RRF . D COY NUI DAT . SP COY (-)  
COURTENAY HILL .

NINE : 1 ARU . 1 PL CMM 2 PL AND 3 PL NUI DAT .

TEN : D AND E PL NUI DAT .

ELEVEN : 2 SAS SQN HAS 4 LRRPS DEPLOYED

PAGE ONE OF ONE PAGES

CLASSIFIED YES

ESMONDE GS03 (OPS)

EBONY 10

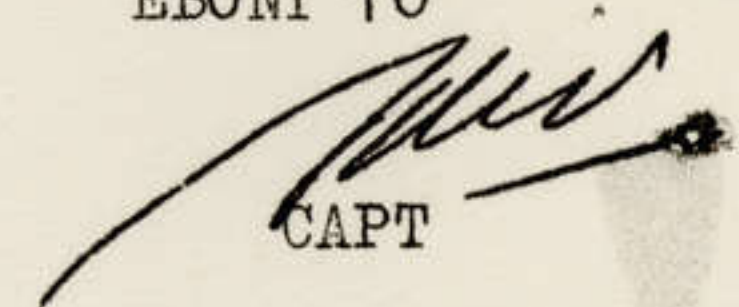

CAPT

MESSAGE FORM

PRIORITY

PRIORITY

121020Z JUL 71

R569/1/82

CONFIDENTIAL

OPS 1206

FROM : 1 ATF

TO : CG TRAC CG RTAVF 1 ATF LO RTAVF 1 ATF LO XUAN LOC  
1 ATF LO 3 BDE (US) CAV DIV (AM)

INFO : AUSTFORCE VIETNAM ~~COMP~~ ~~COMP~~ ~~OPS~~ ~~OPS~~

ATTN : G3 (OPS) : PLANS SUMMARY FOR PERIOD 140001H TO 142400H JUL 71 .

ONE : 1 ATF HQ NUI DAT :

TWO : C SQN 1 ARMD REGT : SQN HQ CMM TP NUI DAT : TP NUI DAT 1 ATF RRF . TP  
FSB MARY OP CON 12 FD REGT . FWD DEL TP NUI DAT .

THREE : A SQN 3 CAV REGT : SQN HQ NUI DAT . TP NUI DAT 1 ATF RRF . TP AO  
BIRDSVILLE OP CON 4 RAR/NZ(ANZAC) . TP AO GLENELG OP CON 3 RAR . SP TP  
NDP CAROL . ELMS FSB MARY CMM NDP SUSAN CMM AO GLENELG AND FSB MAUREEN :

FOUR : 1 ATF ARTILLERY : REGT HQ NUI DAT . A FD BTY CLN SECT NUI DAT CMM SECT  
FSB ZIGGIE . 104 FD BTY CLN SECT FSB MARY CMM SECT FSB MAUREEN . C BTY  
(-) 5/42 (US) ARTY NUI DAT .

FIVE : 1 FD SQN . SQN HQ NUI DAT . ELMS CONTINUE TO SP C SQN 1 ARMD REGT A  
SQN 3 CAV REGT AND BOTH INF BNS . LCT NDP CAROL (YS 5571) . MCT NUI  
DAT : ROAD RECONSTRUCTION EAST OF BINH GIA (ROUTE 327) CONTINUES :

SIX : 17 CONST SQN . SQN HQ NUI DAT . RF HOUSING CMM KERB AND GUTTERING  
BARIA CONTINUES : QUARRY OPS CONTINUE NUI DAT : BRIDGE CONSTRUCTION  
TEAM NDP SUSAN WORKING ON BRIDGE 6 : WELL BORING AN NHUT CONTINUES .  
CONST ROUTE 2 IN NORTH OF PROVINCE AND BARIA CONTINUES :

SEVEN : 3 RAR : BN HQ FSB ZIGGIE A COY FSB ZIGGIE CMM PTL TO THE EAST . B COY  
AO GLENELG : C COY NUI DAT : D COY (-) DEPLOYS TO NUI DAT . SP COY AO  
GLENELG :

EIGHT : 4 RAR/NZ(ANZAC) . BN HQ COURTENAY HILL . V COY AND B COY AO BIRDSVILLE .  
C COY (-) AO BIRDSVILLE CMM PL NUI DAT 1 ATF RRF : D COY NUI DAT . SP  
COY (-) COURTENAY HILL :

NINE : 1 ARU . 1 PL CMM 2 PL AND 3 PL NUI DAT .

TEN : D AND E PL NUI DAT :

ELEVEN : 2 SAS SQN HAS 4 LRRPS DEPLOYED

PAGE 1 OF 1 PAGES

CLASSIFIED YES

ESMONDE GS03 (OPS)

EBONY 10

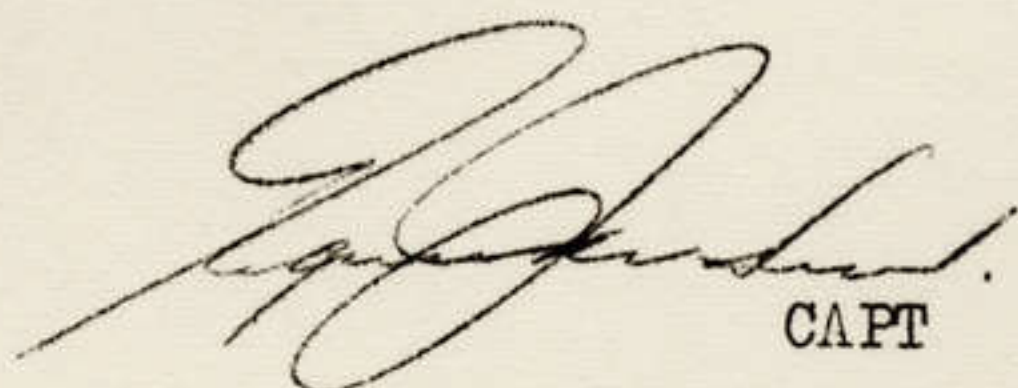

CAPT

MESSAGE FORM

22

PRIORITY PRIORITY 13 1000 Z JUL 71 R569-1-82  
 FROM : 1 ATF CONFIDENTIAL  
 TO : CG TRAC CG RTAVF 1 ATF LO RTAVF 1 ATF LO XUAN LOC OPS 1210  
 1 ATF LO 3 BDE (US) CAV DIV (AM)  
 INFO : AUSTFORCE VIETNAM ~~COMP~~ ~~Ø COMP~~ ~~ØØØZ (ØØØ)~~ ~~ØØØØ (ØØØ)~~  
 ATTN : G3 (OPS) . PLANS SUMMARY FOR PERIOD 150001H TO 152400H JUL 71 .  
 ONE : 1 ATF HQ NUI DAT .  
 TWO : C SQN 1 ARMD REGT . SQN HQ CMM TP NUI DAT . TP NUI DAT 1 ATF RRF . TP  
 FSB MARY OP CON 12 FD REGT . FWD DEL TP NUI DAT CMM STAND DOWN PRIOR TO RTA .  
 THREE : A SQN 3 CAV REGT . SQN HQ NUI DAT . TP NUI DAT 1 ATF RRF . TP AO  
 BIRDSVILLE OP CON 4 RAR/NZ(ANZAC) . TP AO GLENELG OP CON 3 RAR . SP TP  
 NDP CAROL . ELMS FSB MARY CMM NDP SUSAN CMM AO GLENELG AND FSB MAUREEN .  
 FOUR : 1 ATF ARTILLERY . REGT HQ NUI DAT . A FD BTY CLN SECT NUI DAT CMM SECT  
 FSB ZIGGIE . 104 FD BTY CLN SECT FSB MARY CMM SECT FSB MAUREEN . C BTY  
 (-) 5/42 (US) ARTY NUI DAT .  
 FIVE : 1 FD SQN . SQN HQ NUI DAT . ELMS CONTINUE TO SP C SQN 1 ARMD REGT A SQN  
 3 CAV REGT AND BOTH INF BNS . LCT NDP CAROL (YS 5571) . MCT NUI DAT .  
 ROAD RECONSTRUCTION EAST OF BINH GIA (ROUTE 327) CONTINUES .  
 SIX : 17 CONST SQN . SQN HQ NUI DAT . RF HOUSING CMM KERB AND GUTTERING  
 BARIA CONTINUES . QUARRY OPS CONTINUE NUI DAT . BRIDGE CONSTRUCTION  
 TEAM NDP SUSAN WORKING ON BRIDGE 6 . WELL BORING AN NHUT CONTINUES .  
 CONST ROUTE 2 IN NORTH OF PROVINCE AND BARIA CONTINUES .  
 SEVEN : 3 RAR . BN HQ FSB ZIGGIE A COY FSB ZIGGIE CMM PTL TO THE EAST . B COY  
 AO GLENELG . C COY DEPLOYED TO AO GLENELG . D COY NUI DAT . SP COY AO  
 GLENELG .  
 EIGHT : 4 RAR/NZ(ANZAC) . BN HQ COURTENAY HILL . V COY AND B COY AO BIRDSVILLE .  
 C COY (-) AO BIRDSVILLE CMM PL NUI DAT 1 ATF RRF . D COY NUI DAT . SP  
 COY (-) COURTENAY HILL .  
 NINE : 1 ARU . 1 PL CMM 2 PL AND 3 PL NUI DAT .  
 TEN : D AND E PL NUI DAT .  
 ELEVEN : 2 SAS SQN HAS 3 LRRPS DEPLOYED

PAGE ONE OF ONE PAGES CLASSIFIED YES ESMONDE GSO3 (OPS) EBCNY 10

*[Signature]*  
 CAPT



MESSAGE FORM

PRIORITY PRIORITY 14/005 Z JUL 71 R569-1-82

FROM : 1 ATF CONFIDENTIAL

TO : CG TRAC CG RTAVF 1 ATF LO RTAVF 1 ATF LO XUAN LOC OPS 1216  
 1 ATF LO 3 BDE (US) CAV DIV (AM)

INFO : AUSTFORCE VIETNAM ~~COMP~~ ~~OP~~ ~~COMP~~ ~~OP~~ ~~COMP~~ ~~OP~~

ATTN : G3 (OPS) . PLANS SUMMARY FOR PERIOD 160001H TO 162400H JUL 71 .

ONE : 1 ATF HQ NUI DAT .

TWO : C SQN 1 ARMD REGT . SQN HQ CMM TP NUI DAT : TP NUI DAT 1 ATF RRF : TP  
 FSB MARY OP CON 12 FD REGT :

THREE : A SQN 3 CAV REGT : SQN HQ NUI DAT : TP NUI DAT 1 ATF RRF : TP AO  
 BIRDSVILLE OP CON 4 RAR/NZ(ANZAC) : TP AO GLENELG OP CON 3 RAR : SP TP  
 NDP CAROL : ELMS FSB MARY CMM NDP SUSAN CMM AO GLENELG AND FSB MAUREEN :

FOUR : 1 ATF ARTILLERY : REGT HQ NUI DAT : A FD BTY CLN SECT NUI DAT CMM SECT  
 FSB ZIGGIE : 104 FD BTY CLN SECT FSB MARY CMM SECT FSB MAUREEN : C BTY  
 (-) 5/42 (US) ARTY NUI DAT :

FIVE : 1 FD SQN . SQN HQ NUI DAT : ELMS CONTINUE TO SP C SQN 1 ARMD REGT CMM  
 A SQN 3 CAV REGT AND BOTH INF BNS : LCT NDP CAROL (YS5571) : MCT NUI DAT:  
 ROAD RECONSTRUCTION EAST OF BINH GIA (ROUTE 327) CONTINUES :

SIX : 17 CONST SQN . SQN HQ NUI DAT : RF HOUSING CMM KERB AND GUTTERING  
 BARIA CONTINUES . QUARRY OPS CONTINUE NUI DAT . BRIDGE CONSTRUCTION  
 TEAM NDP SUSAN WORKING ON BRIDGE 6 . WELL BORING AN NHUT CONTINUES :  
 CONST ROUTE 2 IN NORTH OF PROVINCE AND BARIA CONTINUES :

SEVEN : 3 RAR . BN HQ FSB ZIGGIE A COY FSB ZIGGIE CMM PTL TO THE EAST : B COY  
 AO GLENELG . C COY AO GLENELG : D COY NUI DAT : SP COY AO GLENELG :

EIGHT : 4 RAR/NZ(ANZAC) . BN HQ COURTENAY HILL . V COY AND B COY AO BIRDSVILLE :  
 C COY (-) AO BIRDSVILLE CMM PL NUI DAT 1 ATF RRF : D COY NUI DAT : SP  
 COY (-) COURTENAY HILL :

NINE : 1 ARU : 1 PL CMM 2 PL AND 3 PL NUI DAT .

TEN : D AND E PL NUI DAT .

ELEVEN : 2 SAS SQN HAS 4 LRRPS DEPLOYED

PAGE ONE OF ONE PAGES CLASSIFIED YES ESMONDE GSO3 (OPS) EBONY 10

*[Handwritten Signature]*  
 CAPT

24

MESSAGE FORM

15/005 Z JUL 71

R569/1/82

PRIORITY PRIORITY

FROM : 1 ATF

CONFIDENTIAL

TO : CG TRAC CG RTAVF 1 ATF LO RTAVF 1 ATF LO XUAN LOC  
1 ATF LO 3 BDE 1ST (US) CAV DIV (AM)

OPS 1223

INFO : AUSTFORCE VIETNAM COMD D COMD GSO2 (OPS) GSO3 (OPS)

ATTN : G3 (OPS) . PLAN SUMMARY FOR PERIOD 170001H TO 1724001H JUL 71 .

ONE : 1 ATF HQ NUI DAT .

TWO : C SQN 1 ARMD REGT . SQN HQ CMM TP NUI DAT . TP NUI DAT 1 ATF RRF . TP FSB MARY  
OP CON 12 FD REGT .

THREE : A SQN 3 CAV REGT . SQN HQ NUI DAT . TP NUI DAT 1 ATF RRF . TP AO BIRDSVILLE OP  
CON 4 RAR/NZ(ANZAC) . TP AO GLENELG OP CON 3 RAR . SP TP NDP CAROL . ELMS FSB  
MARY CMM NDP SUSAN CMM AO GLENELG AND FSB LYNETTE .

FOUR : 1 ATF ARTILLERY . REGT HQ NUI DAT . A FD BTY CLN SECT DEPLOYED TO FSB LYNETTE  
(YS5763) ON 15 JUL CMM SECT FSB ZIGGIE . 104 FD BTY CLN SECT FSB MARY CMM SECT  
REDEPLOYED TO NUI DAT ON 15 JUL . C BTY (-) 5/42 (US) ARTY NUI DAT .

FIVE : 1 FD SQN . SQN HQ NUI DAT . ELMS CONTINUE TO SP C SQN 1 ARMD REGT CMM A SQN  
3 CAV REGT AND BOTH INF BNS . LCT NDP CAROL (YS5571) . MCT NUI DAT . ROAD  
RECONSTRUCTION EAST OF BINH GIA (ROUTE 327) CONTINUES .

SIX : 17 CONST SQN . SQN HQ NUI DAT . RF HOUSING CURB AND GUTTERING BARIA CONTINUES .  
QUARRY OPS CONTINUE NUI DAT . BRIDGE CONSTRUCTION TEAM NDP SUSAN WORKING ON  
BRIDGE 6 . WELL BORING AN NHUT CONTINUES . CONST ROUTE 2 IN NORTH OF  
PROVINCE AND BARIA CONTINUES .

SEVEN : 3 RAR . BN HQ FSB ZIGGIE CMM A COY FSB ZIGGIE CMM PL NDP CAROL . B COY AO  
GLENELG . C COY AO GLENELG . D COY NUI DAT . SP CIY AO GLENELG .

EIGHT : 4 RAR/NZ(ANZAC) . BN HQ COURTENAY HILL . V COY AND B COY AO BIRDSVILLE . C COY  
BIRDSVILLE . D COY NUI DAT 1 ATF RRF FROM 15 JUL . SP COY (-) COURTENAY HILL .

NINE : 1 ARU . 1 PL CMM 2 PL AND 3 PL NUI DAT .

TEN : D AND E PL NUI DAT .

ELEVEN : 2 SAS/SQN HAS 4 LRRPS DEPLOYED

PAGE ONE OF ONE PAGES CLASSIFIED YES

ESMONDE GSO3 (OPS)

EBONY 10

CAPT

25

MESSAGE FORM

PRIORITY

PRIORITY

161005 Z JUL 71

R569/1/82

FROM : 1 ATF

CONFIDENTIAL

TO : CG TRAC CG RTAVF 1 ATF LO RTAVF 1 ATF LO XUAN LOC OPS1227  
1 ATF LO 3 BDE 1ST (US) CAV DIV (AM)

INFO : AUSTFORCE VIETNAM ~~COMP~~ ~~Ø~~ ~~COMP~~ ~~Ø~~ ~~SOZ (ØPS)~~ ~~Ø~~ ~~SOZ (ØPS)~~

ATTN : G3 (OPS) . PLAN SUMMARY FOR PERIOD 180001H TO 182400H JUL 71 .

ONE : 1 ATF HQ NUI DAT .

TWO : C SQN 1 ARMD REGT . SQN HQ CMM TP NUI DAT . TP NUI DAT 1 ATF RRF . TP FSB MARY  
OP CON 12 FD REGT .

THREE : A SQN 3 CAV REGT . SQN HQ NUI DAT . TP NUI DAT 1 ATF RRF . TP AO BIRDSVILLE OP  
CON 4 RAR/NZ(ANZAC) . TP AO GLENELG OP CON 3 RAR . SP TP NDP CAROL . ELMS FSB  
MARY CMM NDP SUSAN CMM AO GLENELG AND FSB LYNNETTE .

FOUR : 1 ATF ARTILLERY . REGT HQ NUI DAT . A FD BTY CLN SECT FSB LYNNETTE (YS5763)  
CMM SECT FSB ZIGGIE . 104 FD BTY CLN SECT NUI DAT CMM SECT FSB MARY . C BTY  
(-) 5/42 (US) ARTY NUI DAT .

FIVE : 1 FD SQN . SQN HQ NUI DAT . ELMS CONTINUE TO SP C SQN 1 ARMD REGT CMM A SQN  
3 CAV REGT AND BOTH INF BNS . LCT NDP CAROL (YS5571) . MCT NUI DAT . ROAD  
RECONSTRUCTION EAST OF BINH GIA (ROUTE 327) CONTINUES .

SIX : 17 CONST SQN . SQN HQ NUI DAT . RF HOUSING CMM KERB AND GUTTERING BARIA  
CONTINUES . QUARRY OPS CONTINUE NUI DAT . BRIDGE CONSTRUCTION TEAM NDP SUSAN  
WORKING ON BRIDGE 6 . WELL BORING AN NHUT CONTINUES . CONST OF ROUTE 2 IN NORTH  
OF PROVINCE AND BARIA CONTINUED . CONST AT JWTC COMMENCED 16 JUL .

SEVEN : 3 RAR . BN HQ FSB ZIGGIE CMM A COY (-) DEPLOYED AO GLENELG ON 16 JUL CMM  
PL NDP CAROL . B COY AO GLENELG . C COY AO GLENELG . D COY NUI DAT . SP COY  
AO GLENELG .

EIGHT : 4 RAR/NZ(ANZAC) . BN HQ COURTENAY HILL . V COY CMM B COY AND C COY AO  
BIRDSVILLE . D COY NUI DAT 1 ATF RRF . SP COY (-) COURTENAY HILL .

NINE : 1 ARU . 1 PL CMM 2 PL AND 3 PL NUI DAT .

TEN : D AND E PL .DEPLOYED TO FSB ZIGGIE ON 16 JUL .

ELEVEN : 2 SAS SQN HAS 5 LRRPS DEPLOYED

PAGE ONE OF ONE PAGES

CLASSIFIED YES

ESMONDE

GS03 (OPS)

EBONY 10

*[Handwritten Signature]*  
CAPT

MESSAGE FORM

PRIORITY PRIORITY 17 1005 Z JUL 71 R569/1/32  
 FROM : 1 ATF CONFIDENTIAL  
 TO : CG TRAC CG RTAVF 1 ATF LO RTAVF 1 ATF LO XUAN LOC OPS 1231  
 1 ATF LO 3 BDE (US) CAV DIV (AM)  
 INFO : AUSTFORCE VIETNAM ~~ØØØØ~~ ~~Ø ØØØØ~~ ~~ØØØØ (ØØØ)~~ ~~ØØØØ (ØØØ)~~  
 ATTN : G3 (OPS) . PLAN SUMMARY FOR PERIOD 190001H TO 192400H JUL 71 .  
 ONE : 1 ATF HQ NUI DAT .  
 TWO : C SQN 1 ARMD REGT . SQN HQ CMM TP NUI DAT . TP NUI DAT 1 ATF RRF . TP  
 DEPLOYED COURTENAY HILL OP CON 4 RAR/NZ(ANZAC) ON 18 JUL .  
 THREE : A SQN 3 CAV REGT . SQN HQ NUI DAT . TP NUI DAT 1 ATF RRF . TP AO BIRDSVILLE  
 OP CON 4 RAR/NZ(ANZAC) . TP AO GLENELG OP CON 3 RAR . SP TP NDP JUDITH  
 (YS5772) . ELMS FSB DEBBIE CMM NDP SUSAN CMM AO GLENELG AND FSB LYNETTE .  
 FOUR : 1 ATF ARTILLERY . REGT HQ NUI DAT . A FD BTY CLN SECT FSB LYNETTE (YS5763)  
 CMM SECT FSB ZIGGIE . 104 FD BTY CLN SECT NUI DAT CMM SECT DEPLOYED FSB  
 DEBBIE (YS4489) ON 18 JUL . C BTY (-) 5/42 (US)ARTY NUI DAT .  
 FIVE : 1 FD SQN . SQN HQ NUI DAT . ELMS CONTINUE TO SP C SQN 1 ARMD REGT CMM A SQN  
 3 CAV REGT AND BOTH INF BNS . LCT REDEPLOYS TO NDP JUDITH (YS5772) . MCT  
 NUI DAT . ROAD RECONSTRUCTION EAST OF BINH GIA (ROUTE 327) CONTINUES .  
 SIX : 17 CONST SQN . SQN HQ NUI DAT . RF HOUSING CMM KERB AND GUTTERING BARIA  
 CONTINUES . QUARRY OPS CONTINUE NUI DAT . BRIDGE CONSTRUCTION TEAM NDP  
 SUSAN WORKING ON BRIDGE 6 . WELL BORING AN NHUT CONTINUES . CONST OF ROUTE  
 2 IN NORTH OF PROVINCE AND BARIA CONTINUES. CONST AT JWTC CONTINUES .  
 SEVEN : 3 RAR . BN HQ FSB ZIGGIE CMM A COY (-) AO GLENELG . CMM PL NDP  
 CAROL . B COY AO GLENELG . C COY AO GLENELG . D COY DEPLOYED AO GLENELG ON  
 18 JUL . SP COY AO GLENELG .  
 EIGHT : 4 RAR/NZ(ANZAC) . BN HQ COURTENAY HILL . V COY CMM B COY AND C COY AO  
 BIRDSVILLE . D COY NUI DAT 1 ATF RRF . SP COY (-) COURTENAY HILL .  
 NINE : 1 ARU . 1 PL CMM 2 PL AND 3 PL NUI DAT .  
 TEN : D AND E PL DEPLOYED TO FSB ZIGGIE ON 16 JUL .  
 ELEVEN : 2 SAS SQN HAS 5 LRRPS DEPLOYED

PAGE ONE OF ONE PAGES CLASSIFIED YES ESMONDE GS03 (OPS) EBONY 10



CAPT

MESSAGE FORM

PRIORITY PRIORITY 18/000Z JUL 71 R569/1/82

FROM : 1 ATF CONFIDENTIAL

TO : CG TRAC OPS 1236

INFO : AUSTFORCE VIETNAM CG RTAVF 1 ATF LO RTAVF  
 1 ATF LO LONG KHANH SECTOR 1 ATF LO 3 BDE 1ST (US) CAV DIV (AM)  
~~1 ATF~~ ~~1 ATF~~ ~~1 ATF~~ (OPS) ~~1 ATF~~ (OPS)

ATTN : G3 (OPS) . PLANS SUMMARY FOR PERIOD 200001H TO 202400H JUL 71 .

ONE : 1 ATF HQ NUI DAT .

TWO : C SQN 1 ARMD REGT . SQN HQ CMM TP DEPLOYED AO GLENELG 18 JUL . TP  
 NUI DAT 1 ATF RRF . TP COURTENAY HILL OP CON 4 RAR/NZ(ANZAC) .

THREE : A SQN 3 CAV REGT . SQN HQ NUI DAT . TP NUI DAT 1 ATF RRF . TP AO  
 BIRDSVILLE OP CON 4 RAR/NZ(ANZAC) . TP AO GLENELG OP CON 3 RAR . SP TP  
 NDP JUDITH (YS5772) . ELMS FSB DEBBIE CMM NDP SUSAN CMM AO GLENELG AND  
 FSB LYNETTE .

FOUR : 1 ATF ARTILLERY . REGT HQ NUI DAT . A FD BTY CLN SECT FSB LYNETTE  
 (YS5763) CMM SECT FSB ZIGGIE . 104 FD BTY CLN SECT NUI DAT CMM SECT  
 FSB DEBBIE (YS4489) . C BTY (-) 5/42 (US) DEPLOYS FSB CHERIE (YS4590) .

FIVE : 1 FD SQN . SQN HQ NUI DAT . ELMS CONTINUE TO SP C SQN 1 ARMD REGT CMM  
 A SQN 3 CAV REGT AND BOTH INF BNS . LCT NDP JUDITH (YS5772) . MCT  
 NUI DAT . ROAD RECONSTRUCTION EAST OF BINH GIA (ROUTE 327) CONTINUES .

SIX : 17 CONST SQN . SQN HQ NUI DAT . RF HOUSING CMM KERB AND GUTTERING BARIA  
 CONTINUES . QUARRY OPS CONTINUE NUI DAT . BRIDGE CONSTRUCTION TEAM NDP  
 SUSAN WORKING ON BRIDGE 6 . WELL BORING AN NHUT CONTINUES . CONST ROUTE  
 2 NORTH OF PROVINCE AND BARIA CONTINUES . CONST JWTC CONTINUES .

SEVEN : 3 RAR . BN HQ FSB ZIGGIE CMM A COY (-) AO GLENELG CMM PL NDP JUDITH .  
 B COY AO GLENELG . C COY AO GLENELG . D COY AO GLENELG . SP COY (-)  
 AO GLENELG .

EIGHT : 4 RAR/NZ(ANZAC) . BN HQ COURTENAY HILL . V COY CMM B COY AND C COY AO  
 BIRDSVILLE . D COY NUI DAT 1 ATF RRF . SP COY (-) COURTENAY HILL .

NINE : 1 ARU . 1 PL CMM 2 PL AND 3 PL NUI DAT .

TEN : D AND E PL FSB ZIGGIE .

ELEVEN : 2 SAS SQN 4 LRRPS DEPLOYED

*[Handwritten Signature]*  
 CAPT

MESSAGE FORM

28

PRIORITY PRIORITY 19 1330 Z JUL 71 R569/1/82  
 FROM : 1 ATF CONFIDENTIAL  
 TO : CG TRAC OPS 1240  
 INFO : AUSTFORCE VIETNAM CG RTAVF 1 ATF LO RTAVF  
 1 ATF LO LONG KHANH SECTOR 1 ATF LO 3 BDE 1ST (US) CAV DIV (AM)  
~~1 ATF LO 3 BDE 1ST (US) CAV DIV (AM)~~  
~~1 ATF LO 3 BDE 1ST (US) CAV DIV (AM)~~  
 ATTN : G3 (OPS) . PLANS SUMMARY FOR PERIOD 210001H TO 212400H JUL 71 .  
 ONE : 1 ATF HQ NUI DAT .  
 TWO : C SQN 1 ARMD REGT . SQN HQ CMM TP AO GLENELG . TP NUI DAT 1 ATF RRF . TP  
 COURTENAY HILL OP CON 4 RAR/NZ(ANZAC) .  
 THREE : A SQN 3 CAV REGT . SQN HQ NUI DAT . TP NUI DAT 1 ATF RRF . TP AO BIRDSVILLE  
 OP CON 4 RAR/NZ(ANZAC) . TP AO GLENELG OP CON 3 RAR . SP TP NDP JUDITH (YS5772)  
 . ELMS FSB DEBBIE CMM NDP SUSAN FSB CHERIE FSB LYNETTE AND NDP JUDITH .  
 FOUR : 1 ATF ARTILLERY . REGT HQ NUI DAT . A FD BTY CLN SECT FSB LYNETTE (YS 5763)  
 CMM SECT FSB ZIGGIE . 104 FD BTY CLN SECT NUI DAT CMM SECT FSB DEBBIE  
 (YS4489) . C BTY (-) 5/42 (US) ARTY FSB CHERIE (YS4590) .  
 FIVE : 1 FD SQN . SQN HQ NUI DAT . ELMS CONTINUE SP C SQN 1 ARMD REGT CMM  
 A SQN 3 CAV REGT AND BOTH INF BNS . LCT NDP JUDITH (YS5772) . MCT NUI DAT .  
 ROAD RECONSTRUCTION EAST OF BINH GIA ( ROUTE 327) CONTINUES .  
 SIX : 17 CONST SQN . SQN HQ NUI DAT . RF HOUSING CMM KERB AND GUTTERING BARIA  
 CONTINUES . QUARRY OPS CONTINUE NUI DAT . BRIDGE CONSTRUCTION TEAM NDP  
 SUSAN WORKING ON BRIDGE 6 . WELL BORING AN NHUT CONTINUES . CONST ROUTE 2  
 NORTH OF PROVINCE AND BARIA CONTINUES . CONST JWTC CONTINUES .  
 SEVEN : 3 RAR . BN HQ FSB ZIGGIE CMM A COY (-) AO GLENELG CMM PL NDP JUDITH .  
 B COY AO GLENELG . C COY AO GLENELG . D COY AO GLENELG . E COY (-)  
 AO GLENELG .  
 EIGHT : 4 RAR/NZ (ANZAC) . BN HQ COURTENAY HILL . V COY CMM B COY AND C COY AO  
 BIRDSVILLE . D COY NUI DAT 1 ATF RRF . SP(-) COURTENAY HILL .  
 NINE : 1 ARU . 1 PL CMM 2 PL AND 3 PL NUI DAT .  
 TEN : D AND E PL . FSB ZIGGIE OP CON 3 RAR .  
 ELEVEN : 2 SAS SQN HAS 5 LRRPS DEPLOYED

PAGE ONE OF ONE PAGES CLASSIFIED YES ESMONDE GS03 (OPS) EBONY

*[Signature]*  
 CAPT

29

MESSAGE FORM

PRIORITY PRIORITY

20 1100 Z JUL 71

R569-1-82

FROM : 1 ATF

CONFIDENTIAL

TO : CG TRAC

OPS 1245

INFO : AUSTFORCE VIETNAM CG RTAVF 1 ATF LO RTAVF

1 ATF LO LONG KHANH SECTOR 1 ATF LO 3 BDE 1ST (US) CAV DIV (AM)

~~COMP~~ ~~OP~~ ~~COMP~~ ~~OP~~ (OP) ~~OP~~ (OP)

ATTN : G3 (OPS) . PLANS SUMMARY FOR PERIOD 220001H TO 222400H JUL 71 .

ONE : 1 ATF HQ NUI DAT .

TWO : C SQN 1 ARMD REGT . SQN HQ CMM TP AO GLENELG . TP NUI DAT 1 ATF RRF . TP COURTENAY HILL OP CON 4 RAR/NZ(ANZAC) .

THREE : A SQN 3 CAV REGT . SQN HQ BASE PTL BY DAY CMM NUI DAT BY NIGHT . TP BASE PTL BY DAY CMM NUI DAT BY NIGHT CMM 1 ATF RRF . TP TRAC SP AO OP CON 4 RAR/NZ(ANZAC) . TP AO GLENELG OP CON 3 RAR . SP TP NDP JUDITH (YS5772) . ELMS FSB DEBBIE CMM NDP SUSAN FSB CHERIE FSB LYNETTE AND NDP JUDITH .

FOUR : 1 ATF ARTILLERY . REGT HQ NUI DAT . A FD BTY CLN SECT FSB LYNETTE (YS5763) CMM SECT FSB ZIGGIE . 104 FD BTY SECT NUI DAT CMM SECT FSB DEBBIE (YS4489) . C BTY (-) 5/42 (US) ARTY FSB CHERIE (YS4590) .

FIVE : 1 FD SQN . SQN HQ NUI DAT . ELMS CONTINUE SP C SQN 1 ARMD REGT CMM A SQN 3 CAV REGT AND BOTH INF BNS . LCT NDP JUDITH (YS5772) . MCT NUI DAT . ROAD RECONSTRUCTION EAST OF BINH GIA (ROUTE 327) CONTINUES .

SIX : 17 CONST SQN . SQN HQ NUI DAT . RF HOUSING CMM KERB AND GUTTERING BARIA CONTINUES . QUARRY OPS CONTINUE NUI DAT . BRIDGE CONSTRUCTION TEAM NDP SUSAN WORKING ON BRIDGE 6 . WELL BORING AN NHUT CONTINUES . CONST ROUTE 2 NORTH OF PROVINCE AND BARIA CONTINUES . CONST JWTC CONTINUES .

SEVEN : 3 RAR . BN HQ FSB ZIGGIE CMM A COY (-) AO GLENELG CMM PL NDP JUDITH . B COY REDEPLOYED NUI DAT 20 JUL . C COY AO GLENELG . D COY AO GLENELG . SP COY (-) AO GLENELG .

EIGHT : 4 RAR/NZ(ANZAC) . BN HQ COURTENAY HILL . V COY CMM B COY AND C COY TRAC SP AO . D COY NUI DAT 1 ATF RRF . SP COY (-) TRAC SP AO .

NINE : 1 ARU . 1 PL CMM 2 PL AND 3 PL NUI DAT .

TEN : D AND E PL . FSB ZIGGIE OP CON 3 RAR .

ELEVEN : 2 SAS SQN HAS 4 LRRPS DEPLOYED

PAGE ONE OF ONE PAGES

CLASSIFIED YES

ESMONDE GS03 (OPS)

EBONY 10

*M. Mathews*  
CAPT

30

MESSAGE FORM

PRIORITY      PRIORITY      210000Z JUL 71      R569-1-82

FROM : 1 ATF      CONFIDENTIAL

TO : CG TRAC      OPS 1250

INFO : AUSTFORCE VIETNAM    CG RTAVF    1 ATF LO RTAVF  
       1 ATF LO LONG KHANH SECTOR    1 ATF LO 3 BDE 1ST (US) CAV DIV (AM)  
       ~~COMP~~ ~~COMP~~ ~~COMP~~ (OPS)    ~~COMP~~ ~~COMP~~ (OPS)

ATTN : G3 (OPS) . PLANS SUMMARY FOR PERIOD 230001H TO 232400H JUL 71 .

ONE : 1 ATF HQ NUI DAT .

TWO : C SQN 1 ARMD REGT . SQN HQ CMM TP DEPLOYED NUI DAT 21 JUL . TP NUI DAT 1 ATF  
       RRF . TP COURTENAY HILL OP CON 4 RAR/NZ(ANZAC) .

THREE : A SQN 3 CAV REGT . SQN HQ BASE PTL BY DAY CMM NUI DAT BY NIGHT . TP ESCORT  
       TROOP LIFT EAST XUYEN MOC BY DAY CMM NUI DAT BY NIGHT CMM 1 ATF RRF . TP TRAC  
       SPECIAL AO OP CON 4 RAR/NZ(ANZAC) . TP AO GLENELG OP CON 3 RAR . SP TP NDP  
       JUDITH (YS5772) . ELMS FSB DEBBIE CMM NDP SUSAN FSB CHERIE FSB LYNETTE AND  
       NDP JUDITH .

FOUR : 1 ATF ARTILLERY . REGT HQ NUI DAT . A FD BTY CLN SECT FSB LYNETTE (YS5763)  
       CMM SECT FSB ZIGGIE . 104 FD BTY CLN SECT NUI DAT CMM SECT FSB DEBBIE (YS4489) .  
       C BTY (-) 5/42 (US) ARTY FSB CHERIE (YS4590) .

FIVE : 1 FD SQN . SQN HQ NUI DAT . ELMS CONTINUE SP C SQN 1 ARMD REGT CMM A SQN 3 CAV  
       REGT AND BOTH INF BNS . LCT NDP JUDITH (YS5772) . MCT NUI DAT . ROAD  
       RECONSTRUCTION EAST OF BINH GIA (ROUTE 327) CONTINUES .

SIX : 17 CONST SQN . SQN HQ NUI DAT . RF HOUSING CMM CURB AND GUTTERING BARIA  
       CONTINUES . QUARRY OPS CONTINUE NUI DAT . BRIDGE CONSTRUCTION TEAM NDP SUSAN  
       WORKING ON BRIDGE 6 . WELL BORING AN NHUT CONTINUES . CONST ROUTE 2 NORTH OF  
       PROVINCE AND BARIA CONTINUES . CONST JWTC CONTINUES .

SEVEN : 3 RAR . BN HQ FSB ZIEGIE CMM A COY (-) AO GLENELG CMM PL NDP JUDITH . B COY  
       NUI DAT . C COY CMM D COY AND SP COY (-) AO GLENELG .

EIGHT : 4 RAR/NZ(ANZAC) . BN HQ COURTENAY HILL . V COY CMM B COY AND C COY TRAC  
       SPECIAL A O . D COY NUI DAT 1 ATF RRF . SP COY (-) TRAC SPECIAL AO .

NINE : 1 ARU . 1 PL CMM 2 PL AND 3 PL NUI DAT .

TEN : D AND E PL . FSB ZIGGIE OP CON 3 RAR .

ELEVEN : 2 SAS SQN 6 LRRPS DEPLOYED

PAGE ONE OF ONE PAGES

CLASSIFIED YES

ESMONDE GS03 (OPS)

EBONY 10

*Bob [Signature]*  
 CAPTAIN



MESSAGE FORM

3,

PRIORITY PRIORITY

221115H Jul 71

R569/1/82

CONFIDENTIAL

OPS1255

FROM : 1 ATF

TO : CG TRAC

INFO : AUSTFORCE VIETNAM CG RTAVF 1 ATF LO RTAVF  
 1 ATF LO LONG KHANH SECTOR 1 ATF LO 3 BDE 1ST (US) CAV DIV (AM)  
 COMD D COMD CS02 (OPS) CS03 (OPS)

ATTN : G3 (OPS) . PLANS SUMMARY FOR PERIOD 240001H TO 242400H JUL 71 .

ONE : 1 ATF HQ NUI DAT .

TWO : C SQN 1 ARMD REGT . SQN HQ CMM TP DEPLOYED TRAC SPECIAL AO 22 JUL CMM OP  
 CON 4 RAR/NZ(ANZAC) . TP NUI DAT 1 ATF RRF . TP TRAC SPECIAL AO CMM OP  
 CON 4 RAR/NZ(ANZAC) .

THREE : A SQN 3 CAV REGT . SQN HQ BASE PTL BY DAY CMM NUI DAT BY NIGHT . TP (-)  
 DEPLOYED COURTENAY 22 JUL CMM SECT 1 ATF RRF . TP TRAC SPECIAL AO CMM OP  
 CON 4 RAR/NZ(ANZAC) . TP AO GLENELG CMM OP CON 3 RAR . SP TP NDP JUDITH  
 (YS5772) . ELMS FSB DEBBIE CMM NDP SUSAN CMM FSB CHERIE CMM FSB LYNETTE  
 AND NDP JUDITH .

FOUR : 1 ATF ARTILLERY . REGT HQ NUI DAT . A FD BTY CLN SECT FSB LYNETTE CMM SECT  
 FSB ZIGGIE . 104 FD BTY CLN SECT NUI DAT CMM SECT FSB DEBBIE (YS4489) .  
 C BTY (-) 5/42 (US) ARTY FSB CHERIE (YS4590) .

FIVE : 1 FD SQN . SQN HQ NUI DAT . ELMS CONTINUE TO SP C SQN 1 ARMD REGT CMM A  
 SQN 3 CAV REGT AND BOTH INF BNS . LCT NDP JUDITH (YS5772) . MCT NUI DAT .  
 ROAD RECONSTRUCTION EAST OF BINH GIA (ROUTE 327) CONTINUES .

SIX : 17 CONST SQN . SQN HQ NUI DAT . RF HOUSING CMM KERB AND GUTTERING BARIA  
 CONTINUES . QUARRY OPS CONTINUE NUI DAT . BRIDGE CONSTRUCTION TEAM NDP  
 SUSAN WORKING ON BRIDGE 6 . WELL BORING AN NHUT CONTINUES . CONST ROUTE 2  
 NORTH OF PROVINCE AND BARIA CONTINUES . CONST JWTC CONTINUES . RESEALING  
 LUSCOMBE AIRFIELD RECOMMENCED ON 23 JUL .

SEVEN : 3 RAR . BN HQ FSB ZIGGIE . A COY (-) AO GLENELG CMM PL NDP JUDITH . B COY  
 NUI DAT . C COY CMM D COY AND SP COY (-) AO GLENELG .

EIGHT : 4 RAR/NZ(ANZAC) . BN HQ COURTENAY HILL . V COY CMM B COY AND C COY TRAC  
SPECIAL AO . D COY (-) NUI DAT 1 ATF RRF CMM TWO PLS AO COURTENAY CMM  
DEPLOYED 22 JUL ! SP COY (-) TRAC SPECIAL AO !

NINE : 1 ARU ! 1 PL CMM 2 PL AND 3 PL NUI DAT !

TEN : D AND E PL . FSB ZIGGIE CMM OP CON 3 RAR !

ELEVEN: 2 SAS SQN 5 LRRPS DEPLOYED

PAGE TWO OF TWO PAGES CLASSIFIED YES ESMONDE GS03 (OPS) EBONY 10

  
CAPT

32

CONFIDENTIAL

PRIORITY

PRIORITY

23010 Z JUL 71

R 569/1/82

CONFIDENTIAL

OPS1262

- FROM : 1 ATF
- TO : CG TRAC
- INFO : AUSTFORCE VIETNAM CG RTAVF 1 ATF LO RTAVF  
1 ATF LO LONG KAHNH SECTOR 1 ATF LO 3 BDE 1ST (US) CAV DIV (AM)  
~~COMP~~ ~~Ø~~ ~~COMP~~ ~~Ø~~SOZ (ØPØ) ~~Ø~~SOZ (ØPØ)
- ATTN : G3 (OPS) . PLANS SUMMARY FOR PERIOD 250001H TO 252400H JUL 71 .
- ONE : 1 ATF HQ NUI DAT .
- TWO : C SQN 1 ARMD REGT . SQN HQ (-) TRAC SPECIAL AO CMM OP CON 4 RAR/NZ(ANZAC) .  
TP NUI DAT 1 ATF RRF .
- THREE : A SQN 3 CAV REGT . SQN HQ BASE PTL BY DAY CMM NUI DAT BY NIGHT . TP (-)  
COURTENAY CMM OP CON 4 RAR/NZ(ANZAC) CMM SECT NUI DAT CMM 1 ATF RRF . TP  
TRAC SPECIAL AO CMM OP CON 4 RAR/NZ(ANZAC) . TP AO GLENELG CMM OP CON 3 RAR ,  
SP TP NDP JUDITH (YS5772) . ELMS FSB DEBBIE CMM NDP SUSAN CMM FSB CHERIE CMM  
FSB LYNETTE AND NDP JUDITH .
- FOUR : 1 ATF ARTILLERY . REGT HQ NUI DAT . A FD BTY CLN SECT FSB LYNETTE CMM SECT  
FSB ZIGGIE . 104 FD BTY CLN SECT NUI DAT CMM SECT FSB DEBBIE (YS4489) .  
C BTY (-) 5/42 (US) ARTY FSB CHERIE (YS4590) .
- FIVE : 1 FD SQN . SQN HQ NUI DAT . ELMS CONTINUE TO SP C SQN 1 ARMD REGT CMM A SQN  
3 CAV REGT AND BOTH INF BNS . LCT NDP JUDITH (YS5772) . MCT NUI DAT . ROAD  
RECONSTRUCTION EAST OF BINH GIA (ROUTE 327) CONTINUED .
- SIX : 17 CONST SQN . SQN HQ NUI DAT RF HOUSING CMM KERB AND GUTTERING BARIA CONTINUES .  
QUARRY OPS CONTINUE NUI DAT . BRIDGE CONSTRUCTION TEAM NDP SUSAN WORKING ON  
BRIDGE 6 . WELL BORING AN NHUT CONTINUES . CONST ROUTE 2 NORTH OF PROVINCE AND  
BARIA CONTINUES . CONST JWTC CONTINUES . RESEALING LUSCOMBE AIRFIELD CONTINUES .
- SEVEN : 3 RAR . BN HQ FSB ZIGGIE . A COY DEPLOYED TO NUI DAT 23 JUL . B COY NUI DAT .  
C COY CMM D COY AO GLENELG . SP COY (-) AO GLENELG CMM PL NDP JUDITH .
- EIGHT : 4 RAR/NZ(ANZAC) . BN HQ COURTENAY . V COY CMM B COY AND C COY TRAC SPECIAL  
AO . D COY (-) COURTENAY CMM PL NUI DAT CMM 1 ATF RRF . SP COY (-) TRAC  
SPECIAL AO .
- NINE : 1 ARU . 1 PL CMM 2 PL AND 3 PL NUI DAT .
- TEN : D AND E PL . FSB ZIGGIE CMM OP CON 3 RAR .
- ELEVEN : 2 SAS SQN 5 LRRPS DEPLOYED

PAGE ONE OF ONE PAGES

CLASSIFIED YES

ESMONDE GS03 (OPS)

EBONY 10

CAPT

33

MESSAGE FORM

PRIORITY

PRIORITY

240900 Z JUL 71

R569/1/82

CONFIDENTIAL

OPS1267

FROM : 1 ATF  
TO : CG TRAC  
INFO : AUSTFORCE VIETNAM CG RTAVF 1 ATF LO RTAVF 1 ATF LO LONG KHANH SECTOR XUAN LOC  
1 ATF LO 3 BDE 1ST (US) CAV DIV (AM)  
~~COMP~~ ~~COMP~~ ~~SOZ (OPS)~~ ~~SOZ (OPS)~~  
ATTN : G3 (OPS) . PLANS SUMMARY FOR PERIOD 260001H TO 262400H JUL 71 .  
ONE : 1 ATF HQ NUI DAT .  
TQO : C SQN 1 ARMD REGT . SQN (-) TRAC SPECIAL AO OP CON 4 RAR/NZ(ANZAC) .  
TP NUI DAT CMM 1 ATF RRF .  
THREE : A SQN 3 CAV REGT . SQN HQ BASE PTL BY DAY CMM NUI DAT BY NIGHT . TP (-) NUI DAT  
CMM 1 ATF RRF CMM TWO SECTS TRAC SPECIAL AO OP CON 4 RAR/NZ(ANZAC) . TP TRAC  
SPECIAL AO OP CON 4 RAR/NZ(ANZAC) . TP AO GLENELG OP CON 3 RAR .  
SP TP NDP JUDITH (YS5772) . ELMS FSB DEBBIE CMM NDP SUSAN CMM FSB CHERIE CMM  
FSB LYNETTE AND NDP JUDITH .  
FOUR : 1 ATF ARTILLERY . REGT HQ NUI DAT . A FD BTY CLN SECT FSB LYNETTE CMM SECT  
FSB ZIGGIE . 104 FD BTY CLN SECT NUI DAT CMM SECT FSB DEBBIE (YS4489) .  
C BTY (-) 5/42 (US) ARTY FSB CHERIE (YS4590) .  
FIVE : 1 FD SQN . SQN HQ NUI DAT ELMS CONTINUE TO SP C SQN 1 ARMD REGT CMM A SQN  
3 CAV REGT AND BOTH INF BNS . LCT NDP JUDITH (YS5772) . MCT DEPLOY LONG HAI  
NATIONAL TRAINING CENTRE (YS4449) . RECONSTRUCTION EAST OF BINH GIA (ROUTE 327)  
CONTINUES .  
SIX : 17 CONST SQN . SQN HQ NUI DAT . RF HOUSING CMM KERB AND GUTTERING BARIA CONTINUES .  
QUARRY OPS CONTINUE NUI DAT . BRIDGE CONSTRUCTION TEAM NDP SUSAN CMM WORK  
ON BRIDGE 6 CONTINUES . WELL BORING AN NHUT CONTINUES . CONST ROUTE 2 NORTH OF  
PROVINCE AND BARIA CONTINUES . CONST JWTC CONTINUES . RESEALING LUSCOMBE  
AIRFIELD CONTINUES .  
SEVEN : 3 RAR . BN HQ FSB ZIGGIE . A COY NUI DAT . B COY NUI DAT . C COY CMM D COY AO  
GLENELG . SP COY (-) AO GLENELG CMM PL NDP JUDITH .  
EIGHT : 4 RAR/NZ(ANZAC) . BN HQ COURTENAY . V COY CMM B COY AND C COY TRAC SPECIAL AO .  
D COY (-) TRAC SPECIAL AO CMM PL NUI DAT CMM 1 ATF RRF . SP COY (-) TRAC  
SPECIAL AO .  
NINE : 1 ARU . 1 PL CMM 2 PL AND 3 PL NUI DAT .  
TEN : D AND E PL . FSB ZIGGIE OP CON 3 RAR .  
ELEVEN : 2 SAS SQN 3 LRRPS DEPLOYED

PAGE ONE OF ONE PAGES

CLASSIFIED YES

ESMONDE GSO3 (OPS)

EBONY 10

*M. Mathews*  
CAPT

34

MESSAGE FORM

PRIORITY PRIORITY 251400Z JUL 71 R569/1/82  
 FROM : 1 ATF OPS 1269  
 TO : GC TRAC CONFIDENTIAL  
 INFO : AUSTFORCE VIETNAM CG RTAVF 1 ATF LO RTAVF  
 1 ATF LO 3 BDE 1ST (US) CAV DIV (AM)  
~~COMP~~ ~~COMP~~ ~~OPS~~ (OPS) ~~OPS~~ (OPS)  
 ATTN : G3 (OPS) . PLANS SUMMARY FOR PERIOD 270001H TO 272400H JUL 71 .  
 ONE : 1 ATF HQ NUI DAT .  
 TWO : C SQN 1 ARMD REGT . SQN (-) TRAC SPECIAL AO OP CON 4 RAR/NZ(ANZAC) .  
 TP NUI DAT CMM 1 ATF RRF .  
 THREE : A SQN 3 CAV REGT . SQN HQ BASE PTL BY DAY CMM NUI DAT BY NIGHT . TP (-) NUI DAT  
 CMM 1 ATF RRF CMM TWO SECTS TRAC SPECIAL AO OP CON 4 RAR/NZ(ANZAC) . TP TRAC  
 SPECIAL AO OP CON 4 RAR/NZ(ANZAC) . TP AO GLENELG OP CON 3 RAR .  
 SP TP NDP JUDITH (YS5772) . ELMS FSB DEBBIE CMM NDP SUSAN CMM FSB CHERIE CMM  
 FSB LYNETTE AND NDP JUDITH .  
 FOUR : 1 ATF ARTILLERY . REGT HQ NUI DAT . A FD BTY CLN SECT FSB LYNETTE CMM SECT  
 FSB ZIGGIE . 104 FD BTY CLN SECT NUI DAT CMM SECT FSB DEBBIE (YS4489) .  
 C BTY (-) 5/42 (US) ARTY FSB CHERIE (YS4590) .  
 FIVE : 1 FD SQN . SQN NUI DAT ELMS CONTINUE TO SP C SQN 1 ARMD REGT CMM A SQN 3 CAV REGT  
 AND BOTH INF BNS . LCT NDP JUDITH (YS5772) . MCT LONG HAI NATIONAL TRAINING CENTRE  
 (YS4449) . RECONSTRUCTION EAST OF BINH GIA (ROUTE 327) CONTINUES .  
 SIX : 17 CONST SQN . SQN HQ NUI DAT . RF HOUSING CMM KERB AND GUTTERING BARIA CONTINUES .  
 QUARRY OPS CONTINUE NUI DAT . BRIDGE CONSTRUCTION TEAM NDP SUSAN CMM WORKING ON  
 BRIDGE 6 CONTINUES . WELL BORING AN NHUT CONTINUES . CONST ROUTE 2 NORTH OF  
 PROVINCE AND BARIA CONTINUES . CONST JWTC CONTINUES . RESEALING LUSCOMBE  
 AIRFIELD CONTINUES .  
 SEVEN : 3 RAR . BN HQ FSB ZIGGIE . A COY NUI DAT . B COY NUI DAT . C COY CMM D COY AO  
 GLENELG . SP COY (-) AO GLENELG CMM PL NDP JUDITH .  
 EIGHT : 4 RAR/NZ(ANZAC) . BN HQ COURTENAY . V COY REDEPLOYED . NUI DAT 25 JUL CMM 1 ATF RRF  
 CMM B COY CMM C COY AND D COY TRAC SPECIAL AO . SP COY (-) REDEPLOYED NUI DAT  
 25 JUL .  
 NINE : 1 ARU . 1 PL CMM 2 PL AND 3 PL NUI DAT .  
 TEN : D AND E PL . FSB ZIGGIE OP CON 3 RAR .  
 ELEVEN : 2 SAS SQN 4 LRRPS DEPLOYED

PAGE ONE OF ONE PAGES CLASSIFIED YES ESMONDE GS03 (OPS) EBONY 10

*W. Mathews*  
 CAPT

35

MESSAGE FORM

PRIORITY PRIORITY

26 1400 Z JUL 71

R569-1-82

FROM : 1 ATF

OPS 1272

TO : CG TRAC

CONFIDENTIAL

INFO : AUSTFORCE VIETNAM CG RTAVF 1 ATF LO RTAVF 1 ATF LO LONG

KHANH SECTOR XUAN LOC 1 ATF LO 3 BDE (US) CAV DIV (AM)

~~COMP~~ ~~D COMP~~ ~~GSOZ (OPS)~~ ~~GSOZ (OPS)~~

ATTN : G3 (OPS) . PLANS SUMMARY FOR PERIOD 280001 H TO 282400H JUL 71 .

ONE : 1 ATF HQ NUI DAT .

TWO : C SQN 1 ARMD REGT . SQN (-) TRAC SPECIAL AO OP CON 4 RAR/NZ(ANZAC) .

TP NUI DAT CMM 1 ATF RRF .

THREE : A SQN 3 CAV REGT . SQN HQ BASE PTL BY DAY CMM NUI DAT BY NIGHT . TP (-)

NUI DAT CMM 1 ATF RRF CMM TWO SECTS TRAC SPECIAL AO OP CON 4 RAR/NZ(ANZAC) .

TP TRAC SPECIAL AO OP CON 4 RAR/NZ(ANZAC) . TP AO GLENELG OP CON 3 RAR .

SP TP NDP JUDITH (YS5772) . ELMS FSB DEBBIE CMM NDP SUSAN CMM FSB CHERIE CMM

FSB LYNETTE AND NDP JUDITH .

FOUR : 1 ATF ARTILLERY . REGT HQ NUI DAT . A FD BTY CLN SECT FSB LYNETTE CMM SECT

FSB ZIGGIE . 104 FD BTY CLN SECT NUI DAT CMM SECT FSB DEBBIE (YS4489) .

C BTY (-) 5/42 (US) ARTY FSB CHERIE (YS4590) .

FIVE : 1 FD SQN . SQN HQ NUI DAT ELMS CONTINUE TO SP C SQN 1 ARMD REGT CMM A SQN

3 CAV REGT AND BOTH INF BNS . LCT NDP JUDITH (YS5772) . MCT LONG HAI

NATIONAL TRAINING CENTRE (YS4449) . RECONSTRUCTION EAST OF BINH GIA

(ROUTE 327) CONTINUES .

SIX : 17 CONST SQN . SQN HQ NUI DAT . RF HOUSING CMM KERB AND GUTTERING BARIA

CONTINUES . QUARRY OPS CONTINUE NUI DAT . BRIDGE CONSTRUCTION TEAM NDP

SUSAN CMM WORK ON BRIDGE 6 CONTINUES . WELL BORING AN NHUT CONTINUES .

CONST ROUTE 2 NORTH OF PROVINCE AND BARIA CONTINUES . CONST JWTC CONTINUES .

RESEALING LUSCOMBE AIRFIELD CONTINUES .

SEVEN : 3 RAR . BN HQ FSB ZIGGIE . A COY NUI DAT . B COY NUI DAT . C COY AO GLENELG .

D COY REDEPLOYED NUI DAT 26 JUL . SP COY (-) FSB ZIGGIE CMM PL NDP JUDITH .

EIGHT : 4 RAR/NZ(ANZAC) . BN HQ COURTENAY . V COY NUI DAT CMM 1 ATF RRF . B COY CMM

C COY AND D COY TRAC SPECIAL AO . SP COY (-) NUI DAT .

NINE : 1 ARU . 1 PL CMM 2 PL AND 3 PL NUI DAT .

TEN : D AND E PL . FSB ZIGGIE OP CON 3 RAR .

ELEVEN : 2 SAS SQN 4 LRRPS DEPLOYED

PAGE ONE OF ONE PAGES

CLASSIFIED YES

ESMONDE GSO3 (OPS)

EBONY 10

CAPT

## MESSAGE FORM

36

PRIORITY

PRIORITY

271100Z JUL 71

R569-1-82

OPS1301

CONFIDENTIAL

FROM : 1 ATF  
 TO : CG TRAC  
 INFO : AUSTFORCE VIETNAM CG RTAVF 1 ATF LO RTAVF 1 ATF LO 3 BDE  
 1ST (US) CAV DIV (AM) 1 ATF LO LONG KIANG SECTOR XUAN LOC  
 COMD 1 COMD 1S02 (OPS) 1S03 (OPS)  
 ATTN : G3 (OPS) : PLANS SUMMARY FOR PERIOD 290001H TO 292400H JUL 71 .  
 ONE : 1 ATF HQ NUI DAT .  
 TWO : C SQN 1 ARMD REGT : SQN (-) TRAC SPECIAL AO OP CON 4 RAR/NZ(ANZAC) .  
 TP NUI DAT CMM 1 ATF RRF .  
 THREE : A SQN 3 CAV REGT (-) DEPLOYED TRAC SPECIAL AO 28 JUL : ELMS NUI DAT CMM  
 1 ATF RRF CMM FSB DEBBIE CMM NDP SUSAN CMM FSB CHERIE CMM FSB LYNETTE  
 CMM NDP JUDITH AND FSB KATE (YS4288) .  
 FOUR : 1 ATF ARTILLERY : REGT HQ NUI DAT . A FD BTY CLN SECT FSB LYNETTE CMM  
 SECT REDEPLOYED NUI DAT 28 JUL . 104 FD BTY CLN SECT FSB DEBBIE CMM  
 SECT DEPLOYED FSB KATE (YS4288) 28 JUL . C BTY (-) 5/42 (US) ARTY FSB  
 CHERIE (YS4590) .  
 FIVE : 1 FD SQN . SQN HQ NUI DAT . ELMS CONTINUE TO SP C SQN 1 ARMD REGT CMM  
 A SQN 3 CAV REGT AND BOTH INF BNS : LCT NDP JUDITH (YS5772) : MCT  
 REDEPLOYED TRAC SPECIAL AO 28 JUL : RECONSTRUCTION EAST OF BINH GIA  
 (ROUTE 327) CONTINUES .  
 SIX : 17 CONST SQN : SQN HQ NUI DAT . RF HOUSING CMM KERB AND GUTTERING BARIA  
 CONTINUES . QUARRY OPS CONTINUE NUI DAT . BRIDGE CONSTRUCTION TEAM NDP  
 SUSAN CMM WORK ON BRIDGE 6 CONTINUES . WELL BORING AN NHUT CONTINUES .  
 CONST ROUTE 2 NORTH OF PROVINCE AND BARIA CONTINUES : CONST JWTC CONTINUES .  
 RESEALING LUSCOMBE AIRFIELD CONTINUES .  
 SEVEN : 3 RAR . BN HQ REDEPLOYED FSB KATE 28 JUL . A COY CMM B COY DEPLOYED TRAC  
 SPECIAL AO 28 JUL : C COY AO GLENELG OP CON HQ 1 ATF : D COY DEPLOYED  
 TRAC SPECIAL AO 28 JUL . SP COY (-) REDEPLOYED FSB KATE 28 JUL CMM PL  
 NDP JUDITH OP CON HQ 1 ATF .  
 EIGHT : 4 RAR/NZ(ANZAC) : BN HQ COURTENAY . V COY NUI DAT CMM 1 ATF RRF . B COY  
 CMM C COY AND D COY TRAC SPECIAL AO . SP COY (-) NUI DAT .  
 NINE : 1 ARU . 1 PL CMM 2 PL AND 3 PL NUI DAT .  
 TEN : D AND E PL . REDEPLOYED NUI DAT 27 JUL 71 .  
 ELEVEN : 2 SAS SQN 6 LRRPS DEPLOYED

PAGE ONE OF ONE PAGES CLASSIFIED YES ESMONDE GS03 (OPS) EBONY 10

 CAPT

MESSAGE FORM

PRIORITY

PRIORITY

28 // 00 Z JUL 71

R569/1/82

OPS 13 05

CONFIDENTIAL

- FROM : 1 ATF
- TO : CG TRAC
- INFO : AUSTFORCE VIETNAM CG RTAVF 1 ATF LO RTAVF 1 ATF LO 3 BDE  
1ST (US) CAV DIV (AM) 1 ATF LO LONG KHANH SECTOR XUAN LOC  
CØMØ Ø CØMØ ØSØ2 (ØPØ) ØSØ3 (ØPØ)
- ATTN : G3 (OPS) . PLAN SUMMARY FOR PERIOD 300001H TO 302400H JUL 71 .
- ONE : 1 ATF HQ NUI DAT .
- TWO : C SQN 1 ARMD REGT . SQN (-) TRAC SPECIAL AO OP CON 4 RAR/NZ(ANZAC) .  
TP NUI DAT CMM 1 ATF RRF .
- THREE : A SQN 3 CAV REGT (-) TRAC SPECIAL AO AND AO BIRDSVILLE . ELMS NUI DAT  
CMM 1 ATF RRF CMM FSB DEBBIE CMM NDP SUSAN CMM FSB CHERIE CMM FSB  
LYNETTE CMM NDP JUDITH AND FSB KATE (YS4288) .
- FOUR : 1 ATF ARTILLERY . REGT HQ NUI DAT . A FD BTY CLN SECT NUI DAT CMM  
SECT FSB LYNETTE . 104 FD BTY CLN SECT FSB DEBBIE CMM SECT FSB KATE  
(YS4288) . C BTY (-) 5/42 (US) ARTY FSB CHERIE (YS4590) .
- FIVE : 1 FD SQN . SQN HQ NUI DAT . ELMS CONTINUE TO SP C SQN 1 ARMD REGT CMM  
A SQN 3 CAV REGT AND BOTH INF BNS . LCT NDP JUDITH (YS5772) . MCT TRAC  
SPECIAL AO . RECONSTRUCTION EAST OF BINH GIA (ROUTE 327) CONTINUES .
- SIX : 17 CONST SQN . SQN HQ NUI DAT . RF HOUSING KERB AND GUTTERING BARIA  
CONTINUES . QUARRY OPS CONTINUE NUI DAT . BRIDGE CONSTRUCTION TEAM NDP  
SUSAN CMM WORK ON BRIDGE 6 CONTINUES . WELL BORING AN NHUT CONTINUES .  
CONST ROUTE 2 NORTH OF PROVINCE AND BARIA CONTINUES . CONST JWTC CONTINUES.  
RESEALING LUSCOMBE AIRFIELD COMPLETED 28 JUL .
- SEVEN : 3 RAR . BN HQ FSB KATE . A COY TRAC SPECIAL AO . B COY AO BIRDSVILLE .  
C COY AO GLENELG OP CON HQ 1 ATF . D COY TRAC SPECIAL AO . SP COY (-)  
FSB KATE 28 JUL CMM PL NDP JUDITH OP CON HQ 1 ATF .
- EIGHT : 4 RAR/NZ(ANZAC) . BN HQ COURTENAY HILL . V COY NUI DAT CMM 1 ATF RRF .  
B COY CMM C COY AND D COY TRAC SPECIAL AO . SP COY (-) NUI DAT .
- NINE : 1 ARU . 1 PL CMM 2 PL AND 3 PL NUI DAT .
- TEN : D AND E PL-CMM NUI DAT .
- ELEVEN: 2 SAS SQN 6 LRRPS DEPLOYED

PAGE ONE OF ONE PAGES

CLASSIFIED YES

ESMONDE

GS03 (OPS)

EBONY 10

*B. Hill*  
CAPT



MESSAGE FORM

PRIORITY PRIORITY 291100Z JUL 71 R569/1/82  
CONFIDENTIAL

FROM : 1 ATF OPS 1316

TO : CG TRAC

INFO : AUSTFORCE VIETNAM CG RTAVF 1 ATF LO RTAVF 1 ATF LO 3 BDE  
1ST (US) CAV DIV (AM) 1 ATF LO LONG KHANH SECTOR XUAN LOC  
COPD Ø COPD ØSØ2(ØPØ) ØSØ3(ØPØ)

ATTN : G3 (OPS) . PLAMS SUMMARY FOR PERIOD 310001H TO 312400H JUL 71 .

ONE : 1 ATF HQ NUI DAT .

TWO : C SQN 1 ARMD REGT (-) TRAC SPECIAL AO OP CON 4 RAR/NZ(ANZAC) .  
TP NUI DAT CMM 1 ATF RRF .

THREE : A SQN 3 CAV REGT (-) TRAC SPECIAL AO AND AO BIRDSVILLE . ELMS NUI DAT  
CMM 1 ATF RRF CMM FSB DEBBIE CMM NDP SUSAN CMM FSB CHERIE CMM FSB  
LYNETTE CMM NDP JUDITH AND FSB KATE (YS4288) .

FOUR : 1 ATF ARTILLERY . REGT HQ NUI DAT . A FD BTY CLN SECT NUI DAT CMM  
SECT FSB LYNETTE . 104 FD BTY CLN SECT FSB DEBBIE CMM SECT FSB KATE  
(YS4288) . C BTY (-) 5/42 (US) ARTY FSB CHERIE (YS4590) .

FIVE : 1 FD SQN . SQN HQ NUI DAT . ELMS CONTINUE TO SP C SQN 1 ARMD REGT CMM  
A SQN 3 CAV REGT AMD BOTH INF BNS . LCT NDP JUDITH (YS5772) . MCT  
DEPLOYED LONG HAI NATIONAL TRAINING CENTRE 30 JUL . RECONSTRUCTION  
EAST OF BINH GIA (ROUTE 327) CONTINUES .

SIX : 17 CONST SQN . SQN HQ NUI DAT . RF HOUSING CMM CURB AND GUTTERING BARIA  
CONTINUES . QUARRY OPS CONTINUE NUI DAT . BRIDGE CONSTRUCTION TEAM NDP  
SUSAN CMM WORK ON BRIDGE 6 CONTINUES . WELL BORING AN NHUT CONTINUES .  
CONST ROUTE 2 NORTH OF PROVINCE AND BARIA CONTINUES . CONST JWTC CONTINUES .

SEVEN : 3 RAR . BN HQ FSB KATE . A COY TRAC SPECIAL AO . B COY AO BIRDSVILLE .  
C COY REDEPLOYED NUI DAT 30 JUL . D COY TRAC SPECIAL AO . SP COY (-)  
FSB KATE 28 JUL CMM PL NDP JUDITH OP CON HQ 1 ATF .

EIGHT : 4 RAR/NZ(ANZAC) . BN HQ COURTENAY HILL . V COY NUI DAT CMM 1 ATF RRF .  
B COY CMM C COY AND D COY TRAC SPECIAL AO . SP COY (-) NUI DAT .

NINE : 1 ARU . 1 PL CMM 2 PL AND 3 PL NUI DAT .

TEN : D AND E PL CMM NUI DAT .

ELEVEN : 2 SAS SQN 5 LRRPS DEPLOYED

*[Handwritten Signature]*  
CAPTAIN

MESSAGE FORM

**PRIORITY** : PRIORITY  
**FROM** : 1 ATF  
**TO** : CG TRAC  
**INFO** : AUSTFORCE VIETNAM CG RTAVF 1 ATF LO RTAVF 1 ATF LO 3 BDE  
 1ST (US) CAV DIV (AM) 1 ATF LO LONG KHANH SECTOR XUAN LOC  
~~COMP~~ ~~D COMP~~ ~~GS02 (OPS)~~ ~~GS03 (OPS)~~  
**ATTN** : G3 (OPS) . PLANS SUMMARY FOR PERIOD 010001H TO 012400H AUG 71 .  
**ONE** : 1 ATF HQ NUI DAT .  
**TWO** : C SQN 1 ARMD REGT (-) TRAC SPECIAL AO OP CON 4 RAR/NZ(ANZAC) . TP NUI DAT  
 CMM 1 ATF RRF .  
**THREE** : A SQN 3 CAV REGT (-) TRAC SPECIAL AO AND AO BIRDSVILLE . ELMS NUI DAT CMM  
 FSB DEBBIE CMM NDP SUSAN CMM FSB LYNETTE CMM NDP JUDITH AND FSB KATE (YS4288)  
**FOUR** : 1 ATF ARTILLERY : REGT HQ NUI DAT . A FD BTY CLN SECT NUI DAT CMM SECT  
 FSB LYNETTE . 104 FD BTY CLN SECT FSB DEBBIE CMM SECT FSB KATE (YS4288) .  
 C Bty (-) 5/42 (US) ARTY FSB CHERIE (YS4590) .  
**FIVE** : 1 FD SQN . SQN HQ NUI DAT . ELMS CONTINUE TO SP C SQN 1 ARMD REGT CMM  
 A SQN 3 CAV REGT AND BOTH INF BNS . LCT NDP JUDITH (YS5772) . MCT LONG HAI  
 NATIONAL TRAINING CENTRE . RECONSTRUCTION EAST OF BINH GIA (ROUTE 327)  
 CONTINUES .  
**SIX** : 17 CONST SQN . SQN HQ NUI DAT . RF HOUSING CMM KERB AND GUTTERING BARIA  
 CONTINUES . QUARRY OPS CONTINUE NUI DAT . BRIDGE CONSTRUCTION TEAM NDP  
 SUSAN CMM WORK ON BRIDGE 6 CONTINUES . WELL BORING AN NHUT CONTINUES .  
 CONST ROUTE 2 NORTH OF PROVINCE AND BARIA CONTINUES . CONST JWTC CONTINUES .  
**SEVEN** : 3 RAR . BN HQ FSB KATE . A COY TRAC SPECIAL AO . B COY AO BIRDSVILLE .  
 C COY NUI DAT . D COY TRAC SPECIAL AO . SP COY (-) FSB KATE CMM PL NDP  
 JUDITH OP CON HQ 1 ATF .  
**EIGHT** : 4 RAR/NZ(ANZAC) . BN HQ COURTENAY HILL . V COY NUI DAT CMM 1 ATF RRF .  
 B COY CMM C COY AND D COY TRAC SPECIAL AO . SP COY (-) NUI DAT .  
**NINE** : 1 ARU . 1 PL CMM 2 PL AND 3 PL NUI DAT .  
**TEN** : D AND E PL CMM NUI DAT .  
**ELEVEN** : 2 SAS SQN 5 LRRPS DEPLOYED .

PAGE ONE OF ONE PAGES CLASSIFIED YES ESMONDE GS03 (OPS) EBONY 10

*[Handwritten Signature]*  
CAPT

40

MESSAGE FORM

PRIORITY : PRIORITY 311030Z Z 71 R569/1/82

FROM : 1 ATF CONFIDENTIAL

TO : CG TRAC OPS 1326

INFO : AUSTFORCE VIETNAM CG RTAVF 1 ATF LO RTAVF 1 ATF LO 3 BDE 1ST (US)CAV  
 DIV (AM) 1 ATF LO LONG KHANH SECTOR XUAN LOC  
~~COMP~~ ~~COMP~~ ~~OPS~~ (OPS) ~~OPS~~ (OPS)

ATTN : G3 (OPS) . PLANS SUMMARY FOR PERIOD 020001H TO 022400H AUG 71 .

ONE : 1 ATF HQ NUI DAT .

TWO : C SQN 1 ARMD REGT (-) TRAC SPECIAL AO OP CON 4 RAR/NZ(ANZAC) . TP NUI DAT  
 CMM 1 ATF RRF .

THREE : A SQN 3 CAV REGT (-) TRAC SPECIAL AO AND AO BIRDSVILLE . ELMS NUIDAT CMM FSB  
 DEBBIE CMM NDP SUSAN CMM FSB LYNETTE CMM NDP JUDITH AND FSB KATE (YS4288)

FOUR : 1 ATF ARTILLERY . REGT HQ NUI DAT . A FD BTY CLN SECT NUI DAT CMM SECT FSB  
 LYNETTE . 104 FD BTY CLN SECT FSB DEBBIE CMM SECT FSB KATE (YS4288) .

FIVE : 1 FD SQN . SQN HQ NUI DAT . ELMS CONTINUE TO SP C SQN 1 ARMD REGT CMM A SQN  
 3 CAV REGT AND BOTH INF BNS . LCT NDP JUDITH (YS5772) . MCT LONG HAI  
 NATIONAL TRAINING CENTRE . RECONSTRUCTION EAST OF BINH GIA (ROUTE 327)  
 CONTINUES .

SIX : 17 CONST SQN . SQN HQ NUI DAT . RF HOUSING CMM KERB AND GUTTERING BARIA  
 CONTINUES . QUARRY OPS CONTINUE NUI DAT . BRIDGE CONSTRUCTION TEAM NDP  
 SUSAN CMM WORK ON BRIDGE 6 CONTINUES . WELL BORING AN NHUT CONTINUES .  
 CONST ROUTE 2 NORTH OF PROVINCE AND BARIA CONTINUES . CONST JWTC CONTINUES .

SEVEN : 3 RAR . BN HQ FSB KATE . A COY TRAC SPECIAL AO . B COY AO BIRDSVILLE .  
 C COY NUI DAT . D COY TRAC SPECIAL AO . SP COY (-) FSB KATE CMM PL NDP  
 JUDITH OP CON HQ 1 ATF .

EIGHT : 4 RAR/NZ(ANZAC) . BN HQ COURTENAY HILL . V COY NUI DAT CMM 1 ATF RRF .  
 B COY CMM C COY AND D COY TRAC SPECIAL AO . SP COY (-) NUI DAT .

NINE : 1 ARU . 1 PL CMM 2 PL AND 3 PL NUI DAT .

TEN : D AND E PL CMM NUI DAT .

ELEVEN : 2 SAS SQN 4 LRRPS DEPLOYED .

PAGE ONE OF ONE PAGES CLASSIFIED YES ESMONDE GS03 (OPS) EBONY 10

*[Signature]*  
 CAPT

# MESSAGE FORM

FOR COMMUNICATIONS USE

PRECEDENCE PRIORITY	PRECEDENCE INFO PRIORITY	DATE-TIME GROUP 080200Z Jul 71	MESSAGE INDICATORS
FROM: IATF			PRFX
TO: 3RAR HQ Coy IATF IARU			OR
INFO: SAS SQN			SECURITY CLASSIFICATION
INFO: 630ps			RESTRICTED
ATTN SECTOR COMMS			ORIGINATOR'S NUMBER
BASE DEFENCE (1)			OPS 1187

ONE (1) WITH EFFECT 091900H JUL 71 IARU WILL CEASE TO PROVIDE A PROLET TO MAN THE SECTOR NINE BUNKER (1)

TWO (1) AS FROM 091900H JUL 71 THE SECTOR NINE BUNKER WILL BE MANNED BY HQ ~~COY~~ COY IATF AND DCY 3RAR (1) THE COMMITMENT WILL BE FOR INCO AND FIVE (1) DETAILED LIAISON IS TO BE EFFECTED BY SAS SQN WITH HQ COY AND 3RAR (1)

THREE (1) WITH EFFECT 060600H AUG 71 IARU WILL RESUME RESPONSIBILITY FOR THE SECTOR NINE BUNKER (1)

FOUR (1) FROM 091900 JUL to 060600 AUG 71 HQ COY IATF IS RELIEVED OF THE RESPONSIBILITY OF PROVIDING A STANDING PATROL FOR SECTOR NINE (1) OPS 1133 Refers.

ISSUED TO	CLASSIFIED	ORIGINATOR'S NAME	ORIGIN	TEL. NO.
ISSUED TO: 100/100	CLASSIFIED: <input checked="" type="checkbox"/> YES <input type="checkbox"/> NO	ESMONDE	60ps	LB 10

FOR OPERATOR'S USE

DATE	TIME	SYSTEM	OPERATOR	DATE	TIME	SYSTEM	OPERATOR	RELEASING OFFICER'S SIGNATURE
R				D				<i>[Signature]</i> Capt.

MESSAGE FORM

R569/1/11

FOR COMMUNICATIONS USE

PRECEDENCE ACTION ROUTINE	PRECEDENCE INFO ROUTINE	DATE-TIME GROUP 080100Z Jul 71	MESSAGE INSTRUCTIONS
------------------------------	----------------------------	-----------------------------------	----------------------

FROM: IATF	TO: 3RAA ASON 3CAN 12 Fd Regt 1 Fd SQN HQ	INFO: COY IATF (SON IARND, IARI, UKAR/NZ SAS SQN.	SECURITY CLASSIFICATION CONFIDENTIAL
------------	---	---	---

INFO: TOPD SVY 630PS	ATTN: SECTOR COMDS (1)	BASE DEFENCE (1) REF IATF BASE DEF MAP JRN '71	ORIGINATOR'S NUMBER 0751188
----------------------	------------------------	--	--------------------------------

ONE (1) WITH EFFECT 1 MAY 71 COMM. THE FOLLOWING CHANGES TO SECTOR ONE AND NINE OCCURRED (1) EXISTING BOY ALONG THE LINE YS 434682 TO YS 443680 WAS DELETED (1) A NEW BOY RUNNING FROM YS 434682 SOUTH TO YS 434680 COMM WEST OF ROAD COMM THEN ON A GENERAL LINE EAST TO YS 443678 COMM TO MEET BOY SECTOR 8 (1) TWO (1) BUNKERS 295, 296 AND POB POINT IN SECTOR ONE COMM BUNKER 294 REMAINS IN SECTOR NINE COMM NO CHANGE TO OPS 0729 OF 1 MAY 71 (1) THREE (1) AN AMPLNMENT TO IATF BASE DEF MAP JRN '71 COMM MAY BE ANTICIPATED (1)

PAGE 1 OF 1 PAGES	REFERENCES TO MESSAGE	DRAFTER'S NAME ESMONDE	OFFICE Gops	TEL. NO. 1810
FILE REFERENCE	CLASSIFIED <input checked="" type="checkbox"/> YES <input type="checkbox"/> NO			

FOR OPERATOR'S USE				RELEASING OFFICER'S SIGNATURE			
DATE	TIME	SYSTEM	OPERATOR	DATE	TIME	SYSTEM	OPERATOR
R			D				Capl.

MESSAGE FORM

R569/1/11

FOR COMM. OPERATIONS USE

PRECEDENCE PRIORITY	PRECEDENCE INFO	DATE-TIME GROUP	MESSAGE REFERENCES
ROUTINE	ROUTINE	090700Z Jul 71	
FROM:	IATF		PREF: OR
TO:	ASON3CAV		SECURITY CLASSIFICATION
INFO:	G3Ops		RESTRICTED
OPERATOR'S MARKS			
BASE DEFENCE: REF CONV AYRE/ESMONDE			
OF 8 JULY 71 (.)			OPS 1198

ONE (.) ASON 3CAV REGT REQUEST TO CONSTRUCT A NEW PERMANENTLY MANNED BUNKER AT YS 431672 COMM THOUGH CONSIDERED TO BE TACTICALLY SOUND BY THIS HQ COMM HAS BEEN DENIED ON THE FOLLOWING GROUNDS

ALFA (.) ASON ALREADY HAS TWO MANNED BUNKERS COMM WHICH CAN COVER THE GENERAL GROUND IN QUESTION

BRAVO (.) A NEW BUNKER ON THE PROPOSED SITE WOULD MEAN THREE BUNKERS INSTEAD OF TWO COMM WOULD HAVE TO BE MANNED (.) WITH THE PRESENT POLICY OF GRADUAL WITHDRAWAL FROM NUI DAT AND CURRENT OP COMMITMENTS THIS IS NOT CONS PRAC (.)

PAGE 1 OF 1 PAGES	REFERS TO MESSAGE	SENDER'S NAME	OFFICER	TEL. NO.
FILE REFERENCE	CLASSIFIED	ESMONDE	(DPM)	LB 10
	<input checked="" type="checkbox"/> YES <input type="checkbox"/> NO			

FOR OPERATOR'S USE				RELEASING OFFICER'S SIGNATURE			
DATE	TIME	SYSTEM	OPERATOR	DATE	TIME	SYSTEM	OPERATOR
			D				

X782/1/1

Jul 71

Lieutenant Colonel Nguyen Van Tu  
Province Chief  
Phuoc Tay

REPAIR OF NGAI GIANG - HINH GIA ROAD

1. As you are aware, there have been a number of submissions from interested parties for the repair of this section of Route 37. You are also no doubt aware that severe urgent operational tasks have precluded work on this particular task until this time.
2. I am pleased to advise you therefore that engineers of the 1st Australian Task Force have now commenced work on the damaged road. The task will take approximately 6 weeks to complete.

(R.A. McDONALD)  
Brig  
Genl

# MESSAGE FORM

FOR COMA OPERATIONS USE

PRECEDENCE ACTION <b>ROUTINE</b>	PRECEDENCE INFO <b>ROUTINE</b>	DATE/TIME GROUP <b>03/200Z</b>	MESSAGE INSTRUCTIONS
FROM: <b>IATF</b>			PRIO: <b>CR</b>
TO: <b>3RAR, 4RAR/NZ(ANZAC)CSO</b>			SECURITY CLASSIFICATION
INFO: <b>IARMID REGT, ASO3CAV REGT, IARU HQ COV IATF SASO</b>			<b>RESTRICTED</b>
INFO: <b>12FD REGT RAA</b>			OPERATOR'S NUMBER
			<b>OPS 1166</b>

## CONTACT/INCIDENT REPORTS

- ONE (1) WHEN UNITS ARE SUBMITTING CONTACT REPORTS TO THIS HQ AS PER IATF SOPS COMM WOULD THEY SPECIFY AS PER SERIAL 2 H. COMM WHETHER THE CONTACT WAS FRIENDLY OR ENEMY INITIATED.
- TWO (2) COMPLIANCE WITH THE ABOVE ENABLES THIS HQ TO FORWARD TO TRAC ALL CONTACT/INCIDENT REPORTS RECEIVED WITHOUT FURTHER ALTERATION OR ENQUIRY BEING MADE TO INITIATING UNITS
- THREE (3) THIS SIGNAL IS A REMINDER COMM AS THE ABOVE INFORMATION IS INCLUDED ON MOST OCCASIONS.

PAGE <b>1</b> OF <b>1</b> PAGES	COPIES TO MESSAGE	DRAFTER'S NAME	OFFICE	TEL. NO.
FILE REFERENCE	CLASSIFIED <input checked="" type="checkbox"/> YES <input type="checkbox"/> NO	<b>ESMONDE</b>	<b>Ops</b>	<b>10.</b>

FOR OPERATOR'S USE

DATE	TIME	SYSTEM	OPERATOR	DATE	TIME	SYSTEM	OPERATOR
<b>R</b>				<b>D</b>			

RELEASING OFFICER'S SIGNATURE



46

MESSAGE FORM

PRIORITY                      PRIORITY                      03                      Z JUL 71                      R790/1/2  
 FROM                      1 ATF                      CONFIDENTIAL  
 TO                      LIST A (LESS SERIALS 24 - 33)                      OPS 1163

ENEMY SAPPER ATTACKS . REF CMM ALFA . AVIB - GCD OF 15 APR 71 AS REPRODUCED  
 BY 1 ATF R790/1/2 OF 13 MAY 71 . BRAVO . II FFV MSG 030420 OF 311120H MAR 71 .  
 CHARLIE . TRAC MSG 1731200 OF 270900H MAY 71 .

ONE . THE ATTENTION OF CO/OC'S OF UNITS IS DRAWN TO REF A . SUBTENDED  
 BELOW ARE RELEVANT EXTRACTS FROM THE TEXT OF REF B AND C .

TWO . CURRENT INTELLIGENCE AND RECENT SAPPER ATTACKS AGAINST ALLIED  
 INSTALLATIONS CMM INDICATES THAT THIS METHOD OF ATTACK WILL INCREASE CMM  
 AS FWMAF CONTINUE TO WITHDRAW . THE EN HAS FOUND THAT THE ECONOMY  
 OF FORCE SAPPER TYPE ATTACK ENABLES HIM TO CLN

ALFA . INFLECT MAXIMUM DAMAGE AND CASUALTIES .

BRAVO . REDUCE HIS OWN RISK BY USING A RELATIVELY SMALL FORCE .

THREE . THE EN CAREFULLY STUDIES ALLIED DEFENCES CMM OVER A LONG PERIOD OF  
 TIME CMM DETECTING WEAKNESSES AND ESTABLISHED PATTERNS . EN SAPPERS  
 INVARIABLY INFILTRATE THROUGH AREAS WHICH ARE NOT COVERED BY FIRE OR  
 PATROLS .

FOUR . WITH THE REDUCTION OF ALLIED TROOPS IN MR3 AND THE GRADUAL REDUCTION  
 OF AUST TROOPS WITHIN THE 1 ATF TAOR CMM LUCRATIVE TARGETS MAY BE  
 OFFERED TO THE ENEMY CMM AT RELATIVELY LOW RISK TO HIMSELF . WITH  
 THIS IN MIND CO/OC'S ARE TO REVIEW THEIR LOCAL DEFENCE PRECAUTIONS IN  
 THE LIGHT OF REF A CMM AND SHOULD CONSIDER THE FOLLOWING ADDITIONAL  
 PRECAUTIONARY MEASURES .

ALFA . ENSURE CMM QUOTE THE NOTHING HAPPENED HERE DURING THE PAST  
 SIX MONTHS AND THEREFORE NOTHING IS GOING TO HAPPEN ATTITUDE  
 UNQUOTE CMM DOES NOT EXIST WITHIN UNITS/SUB UNITS

BRAVO . ENSURE BASE DEFENCE PLANS AND DEFENCES ARE CONTINUALLY  
 UPGRADED AND REVIEWED CMM WITH PARTICULAR EMPHASIS ON  
 PHYSICALLY CHECKING PERIMETER WIRE FOR BREAKS CMM KEEPING  
 FIRE LANES CLEAR OF FOLIAGE CMM ENSURING FIELD DEFENCES CMM  
 WHERE POSSIBLE CMM ARE COVERED BY FIRE AND A CONTINUOUS  
 PROGRAMME OF MAINTENANCE AND UPGRADING OF BUNKERS AND FIGHTING  
 PITS EXISTS .

CHARLIE . GIVE CONSIDERATION TO VARIATIONS CMM IN BUNKER POSITIONS THAT  
 ARE PERMANENTLY MANNED . THIS DENIES AN ESTABLISHED PATTERN

PAGE 2 OF 2 PAGES

AND INCREASES THE DIFFICULTIES INVOLVED IN RECCE AND ESTABLISHING AN INFILTRATION ROUTE CMM WHILE AT THE SAME TIME HELPS TO UPGRADE THE OVERALL STANDARD OF BUNKER MAINTENANCE .

**DELTA** . ENSURE THAT THERE ARE ADEQUATE BASE DEFENCE PATROLS AND AMBUSHES IN LOCATION TO INTERDICT EN RECCE AND INFILTRATION PARTIES .

**ECHO** . HOLD REGULAR LOCAL DEFENCE REHEARSALS CMM A STAND TO AND THE USE OF COUNTER PENETRATION FORCES CMM TO ENSURE ALL PERSONNEL ARE FAMILIAR WITH THEIR DUTIES .

**FOXTROT** . CONTINUALLY IMPRESS UPON SOLDIERS CMM PERFORMING SENTRY DUTY IN STATIC LOCATIONS CMM EG NDPS AND FSBS AS WELL AS BASE AREAS CMM OF THE IMPORTANCE OF REMAINING ALERT FOR SAPPER TYPE ATTACKS . SENTRIES SHOULD BE WELL BRIEFED ON LIKELY SAPPER TACTICS OF RECCE AND INFILTRATION SO THAT THEY CAN ANTICIPATE ANY SUCH ATTACK .

**SIX** . QUOTE ALL INDICATIONS ARE THAT THE FREQUENCY AND EFFECTIVENESS OF SAPPER ATTACKS WILL INCREASE DURING THE NEXT FEW MONTHS UNLESS POSITIVE PRECAUTIONS ARE UNDERTAKEN IMMEDIATELY UNQUOTE

PAGE 2 OF 2 PAGES

CLASSIFIED YES

ESMONDE

GS03 (OPS)

EBONY 10

  
CAPT

2193/2/1

Jul 71

JWTC

For Information:

104 Sig Sqn

ADDITIONAL OPERATIONAL/NUMERICAL CODES

Reference: A. JWTC letter of 27 Jun 71.

1. Approval is given for the additional sets of codes requested by JWTC to be issued on a regular basis.
2. As noted in paragraph 5 of Reference A strict supervision should be exercised over the security and issue of the codes. It should also be noted that the codes are "for US/AUSF use only".
3. It is understood that the additional codes are for use by the Australian Advisors when an emergency arises so that quick and effective contact can be made with 1 ATF for the provision of support.

(S.W. HOFFERLAND)  
Maj  
For Comd

MESSAGE FORM

2569/1/82

FOR OPERATIONS USE

RECEIVED ACTION <i>Priority</i>	REFERENCE INFO <i>Priority</i>	DATE-TIME GROUP <i>050300Z</i>	MESSAGE NUMBER <i>JUL 71</i>
FROM: <i>IATF</i>			SECURITY CLASSIFICATION <i>CONFIDENTIAL</i>
TO: <i>A SQN 3 CAU REGT</i>			
INFO: <i>12 FD REGT</i> <i>17 CONST SQN</i> <i>H RAR/N2 (AN2AC)</i>			
INFO: <i>1 FD SQN</i> <i>(L50 Ops) ARTY C/P</i>			OPERATOR'S NUMBER <i>015 1175</i>

NI LOC CAU SECT DEPLOYED FOR PROTECTION  
 17 CONST SQN ROAD CONST OPS ROUTE TWO  
 NORTH OF DUC THANH @ WEF NI 5/6 JUL  
 THIS SECT IS TO BE LOC OVER NI AT  
 NUI DAT @ IN EVENT INCREASED THREAT  
 AF FSB MANY MATTER CAN BE REVIEWED @  
 C/S CURRENTLY ENGAGED IN THIS TASK IS  
 TA 86

PAGE <i>1</i> OF <i>1</i> PAGES	REFS TO MESSAGE	OPERATOR'S NAME <i>McFarlane</i>	GRADE <i>GS(OAS)</i>	TEL. NO. <i>Edon/10</i>
SEE REFERENCE	CLASSIFIED <input type="checkbox"/> YES <input type="checkbox"/> NO	FOR OPERATIONS USE		

DATE	TIME	SYSTEM OPERATOR	DATE	TIME	SYSTEM OPERATOR	RELEASING OFFICER'S SIGNATURE <i>[Signature]</i>
						<i>Major</i>

# MESSAGE FORM

FOR COMM. OPERATIONS USE

PRIORITY ACTION

PRIORITY INFO

DATE-TIME GROUP

MESSAGE INSTRUCTIONS

ROUTINE

ROUTINE

060230Z

JUL 71

FROM: IATF

PHONE

OR

TO: LISE A (LESS SERIALS 25 TO 33)

SECURITY CLASSIFICATION

INFO: LIST C

RESTRICTED

ORIGINATOR'S NUMBER

OPS 1179

SECURITY OF DOCUMENTS IN

TRANSIT ①

ONE ① THERE ARE AN INCREASING

NUMBER OF INSTANCES OF DOCUMENTS INCLUDING

LOOSE MAPS COMM CODE WHEELS AND EVEN

CONTAINERS OF DOCUMENTS BEING ALLOWED TO FALL

FROM AIRCRAFT ①

TWO ① ADDRESSEES ARE TO BRING THE MATTER

TO THE ATTENTION OF ALL RANKS SO AS TO IMPROVE

THE SITUATION ①

THREE ① IN THE CASE OF PACKAGES OR BOXES

OF DOCUMENTS OR EVEN ENVELOPES OF DOCUMENTS

BEING DESPATCHED FROM THE ORIGINATOR/AIR

CELL RESPONSIBLE FOR LOADING THE AIRCRAFT

SHOULD BRING THE ATTENTION OF THE

PAGE 1 OF 2 PAGES

REFER TO MESSAGE

ORIGINATOR'S NUMBER

PHONE

OR. NO.

FILE REFERENCE

CLASSIFIED

# MESSAGE FORM

FOR COMMUNICATIONS USE

PRECEDENCE ACTION	PRECEDENCE INFO	DATE-TIME GROUP	MESSAGE INSTRUCTIONS
FROM :			PRIORITY
TO :			OR
INFO :			SECURITY CLASSIFICATION
PAGE TWO			ORIGINATOR'S NUMBER

AIRCRAFT CAPTAIN TO THE MATTER AND  
REQUEST ADVISE ON A SECURE PLACE  
FOR STOWAGE

PAGE 2 OF 2 PAGES	REFERS TO MESSAGE	DRAFTER'S NAME	CLASS	REL. NO.
SELF REFERENCE	CLASSIFIED <input type="checkbox"/> YES <input checked="" type="checkbox"/> NO	McFarlane	LS(OPS)	15307 10

FOR OPERATOR'S USE				RELEASING OFFICER'S SIGNATURE			
DATE	TIME	SYSTEM	OPERATOR	DATE	TIME	SYSTEM	OPERATOR
				BANK Hagen			

FORM 33

AUSTRALIAN MILITARY FORCES

579/1/57

50  
HQ 1 ATF  
NUI DAT  
6 Jul 71

See Distribution List.

CONTINGENCY PLANNING  
UNIT MOVEMENT DATA TABLES

Reference: A. MBI 150-7 Annex G Appendix I.

B. AFV SOP Part 3, Chapter 2, Paras 2008 - 2011.

1. Units are to submit to HQ AFV (copy to this headquarters) by 30 Jul 71, accurate movement data tables in accordance with References A and B.
2. These tables are to include all vehicles, stores and equipment which is estimated with units at the time of an eventual withdrawal. As there will be no Ordnance RSG or other depot facilities remaining at the time of any Task Force withdrawal, the responsibility for the planning of movement of stores and equipment from the theatre remains with individual units. Force bids for shipping space will be made in accordance with unit estimates.
3. Movement data tables are to be accurate and must show ALL items held including regimental and mess property, TWET items and 30 days maintenance scales.
4. Amendments to these tables are to be forwarded to HQ AFV as soon as changes are evident.

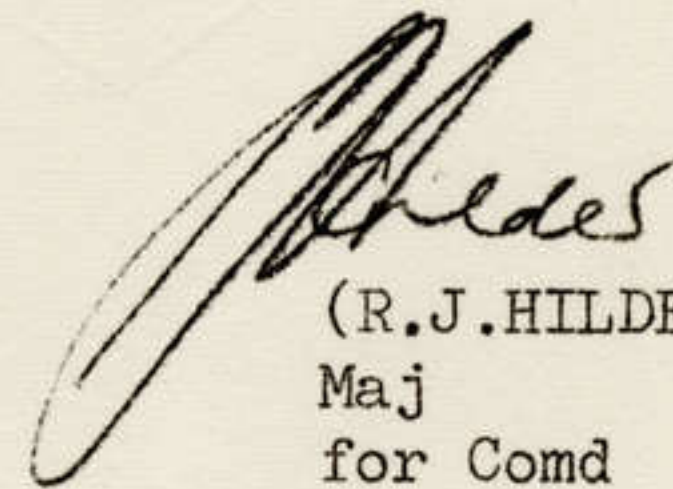
  
(R.J.HILDER)  
Maj  
for Comd

Distribution:

List B (Less serials 4, 12, 24 - 33)

# MESSAGE FORM

FOR COM CRYPTANALYSIS USE

PRECEDENCE CLASSIFICATION <i>ROUTINE</i>	PRECEDENCE INFO	DATE-TIME GROUP <i>080800Z</i>	MESSAGE INSTRUCTIONS <i>JUL 71</i>
FROM: <i>1ATF</i>			PERIOD <i>OR</i>
TO: <i>3RAR 4SQW 3CAU RLT</i>			SECURITY CLASSIFICATION <i>CONFIDENTIAL</i>
INFO: <i>4RAR (NZ (ANZAC))</i> <i>LSO 3 (OPS) CP ARTY TAC</i>			OPERATORS' NUMBER <i>OPS 1193</i>

*CAVALRY - CHANGE IN DEPLOYMENT*

*ONE*  *FOLLOWS TO TAKE EFFECT ON OR ABOUT*  
*MON 19 JUL CLN REVERTING TO UNDER*  
*CONTD ASQW 3CAU RLT FOR RRF*  
*DUTY NUI DAT - 2TP ASQW 3CAU RLT*  
*UNDER OP CON 3RAR - 3TP ASQW*  
*3CAU RLT*

*TWO*  *DETAILED ARRANGEMENTS ARE TO BE*  
*ARRANGED BETWEEN ASQW AND 3RAR*

*THREE*  *NO CHANGE IN DEPLOYMENT IN AMK*  
*SECT OP CON 3RAR IS INTENDED IN*  
*IMMEDIATE FUTURE*

PAGE <i>1</i> OF <i>1</i> PAGES	REFERS TO MESSAGE	OPERATOR'S NAME <i>McFARLANE</i>	GRADE <i>RS(OPS)</i>	TEL. NO. <i>ES0410</i>
FILE REFERENCE	CLASSIFIED <input type="checkbox"/> YES <input checked="" type="checkbox"/> NO			

FOR OPERATOR'S USE

RELEASING OFFICER'S SIGNATURE

RE	DATE	TIME	SYSTEM	OPERATOR	DATE	TIME	SYSTEM	OPERATOR	<i>[Signature]</i>
									<i>King</i>



AUSTRALIAN ARMY

52

R528/1/1

Headquarters  
1st Australian Task Force  
NUI DAT

9 Jul 71

3 RAR  
4 RAR/NZ(ANZAC)

VETERINARY SERVICES AND TRAINING

1. Information has been received from the 4th (US) Medical Detachment LONG BINH that they are prepared to accept dog handlers for periods of three weeks for Veterinary Technician Courses. This is the unit where currently our dogs receive medical attention.
2. Further details can be obtained by ringing Major VAN ZYTVELD on LONG BINH 426-5025 or 926-2937.
3. Battalions are authorised to continue to liaise direct with 4th (US) Med Det on veterinary matters and Technical Training of handlers. 1 ATF HQ should be kept informed of any intention to accept the offer to train handlers so that formal arrangements for detachment can be arranged.

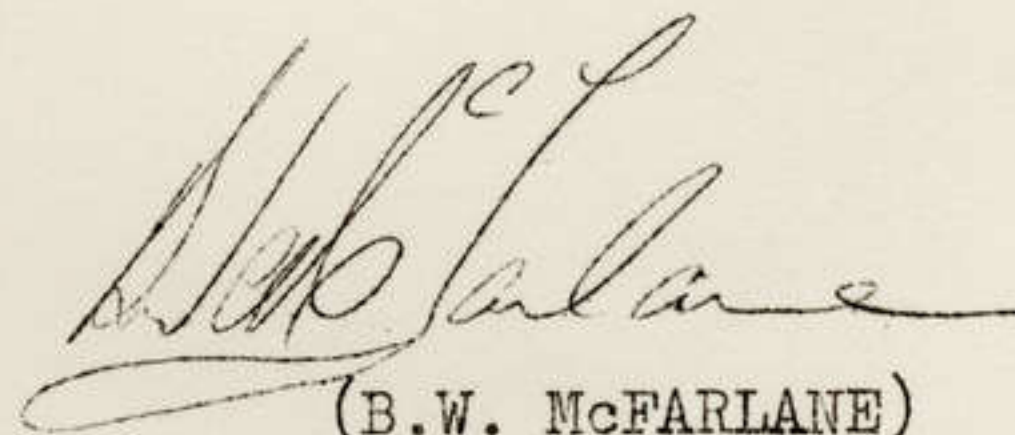

(B.W. McFARLANE)  
Maj  
GS02 (Ops)

For Information:

DAAG  
DAQMG  
GS03 (SD and Trg)  
SMO

MESSAGE FORM

53

PRIORITY PRIORITY

080300Z JUL 71

UNCLAS

FROM : 1 ATF

A 979

TO : LIST A (LESS SERIALS 4, 25-31)

FOR COS/OCS PREVENTION OF INSECT-BORNE DISEASES .

REF . 1 ATF RO PART 1 NO. 111 DATED 15 MAY 71 .

ONE . NOW WET SEASON STARTED CMM INCIDENCE OF INSECT-BORNE DISEASES SHOWING INCREASE .

EVERY EFFORT TO BE MADE BY ALL PERS TO KEEP INCIDENCE OF DISEASES TO LOWEST POSSIBLE LEVEL .

TWO . AERIAL SPRAYING BEING ARRANGED BY HQ 1 ATF . HOWEVER CMM GROUND SPRAYING AND FOGGING PROGRAMME BEING HINDERED BY EQUIPMENT DIFFICULTIES CLN UNIT PREVENTATIVE MEASURES AND PERSONAL PREVENTATIVE MEASURES OUTLINED IN REF MUST THEREFORE BE STRICTLY ADHERED TO .

THREE . UNITS OF COY SIZE NOT HAVING THREE MEMBERS TRAINED IN INSECT DISPERSAL TECHNIQUES TO NOMINATE SQUADS BY 13 JUL 71 TO 1 ATF HYGIENE OFFR (AT 8 FD AMB) WHO WILL ARRANGE NEC TRAINING .

FOUR . STOCKS NOW AVAIL OF BULK INSECT KNOCKDOWN SPRAY CMM AEROSOL KNOCKDOWN DISPENSERS CMM PERS INSECT REPELLANT AND PERS PRESSURE PACK REPELLANT . HANDSPRAYERS AVAIL FROM SELF SERVICE STORE DET 1 OFF . UNITS TO ENSURE THEY MAINTAIN SUFFICIENT HOLDINGS TO FULFIL PREVENTATIVE MEASURES GIVEN IN REF .

PAGE ONE OF ONE PAGES

FRANKLIN

DAAG

EBONY 12



MAJOR

Headquarters  
1st Australian Task Force  
NUI DAT

10 Jul 71

Distribution Below.

DETACHMENT FOR 1 ATF DUTIES

1. It is proposed to amend the current instruction on 1 ATF detachments for duty and to include the amended instruction in 1 ATF SOPs.
2. Attached is a draft copy of the new proposed instruction on 1 ATF detachments.
3. Your comments would be appreciated.
4. Comments are to be made in writing (note form) and are to reach the GS03 (Ops) by 1000 hrs on 16 Jul 71, to enable the amended instruction to be published as early as possible.

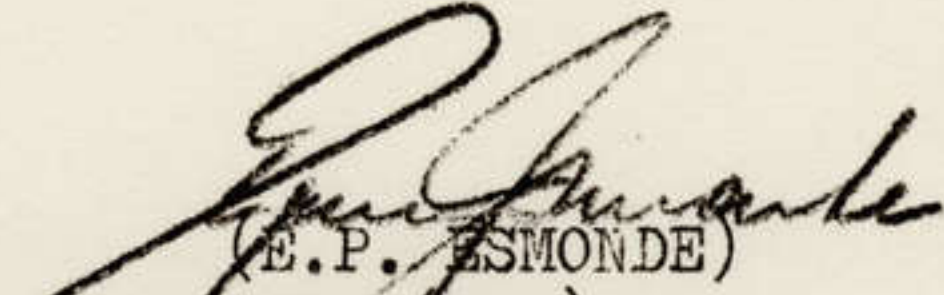
  
(E.P. ESMONDE)  
GS03 (Ops)  
Capt

Distribution:

GS02 (Ops)  
GS03 (Ops)  
DAAG  
DAQMG  
HQ Coy 1 ATF (OC)  
12 Fd Regt  
LO BARIA  
104 Sig Sqn (OC)  
Spare (5)

DETACHMENTS FOR 1 ATF DUTIES

1 ATF Liaison Unit

1. Role. The role of 1 ATF Liaison Unit is to provide liaison between HQ 1 ATF, flanking formations, PHUOC TUY Sector and Sub-Sector HQs and MACCORDS ADV Team 89.

2. Organization. 1 ATF Liaison Unit is a working group of personnel detached to HQ Coy 1 ATF from various units for 1 ATF liaison duties. The outline organization is shown below:

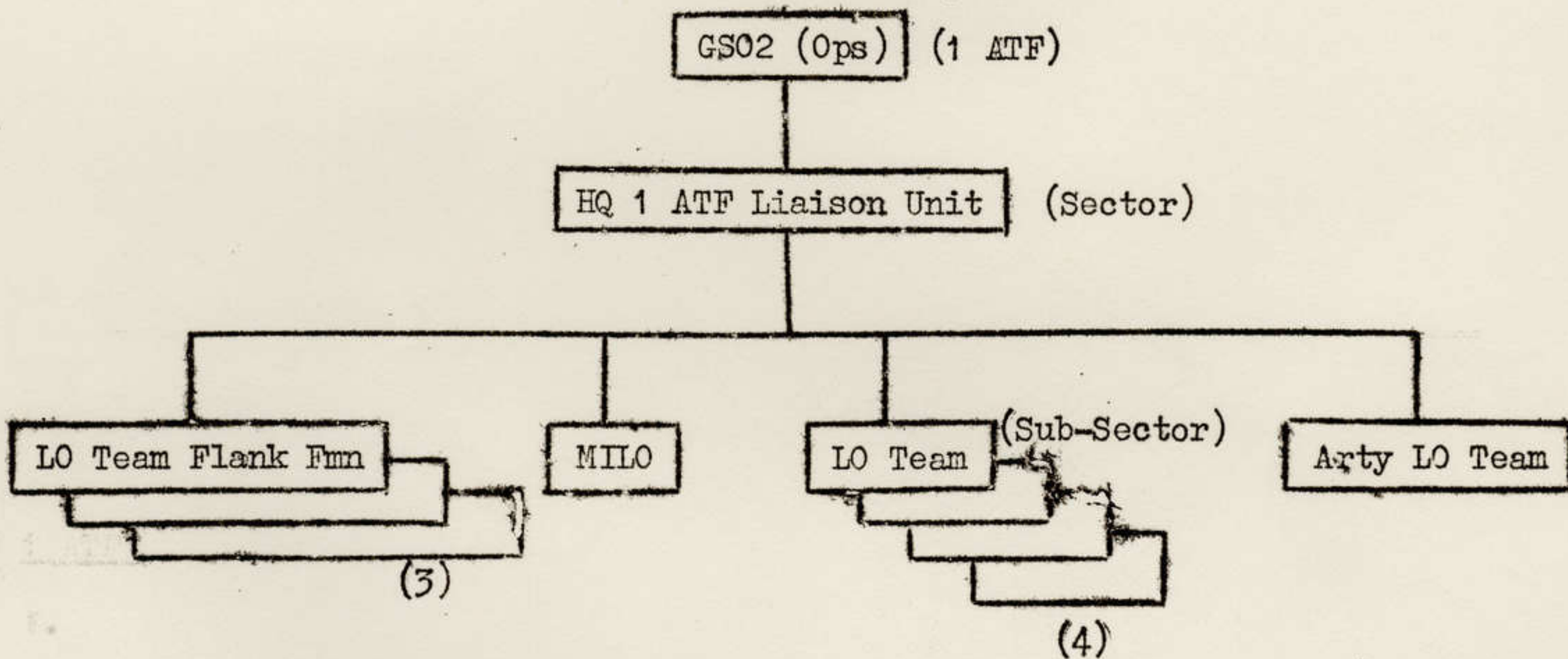

3. The detailed internal organization of 1 ATF Liaison Unit is attached as APPENDIX A.

4. Command and Control

- a. HQ 1 ATF commands all teams of the 1 ATF Liaison Unit, OC HQ Coy 1 ATF is the CO of all ranks for disciplinary purposes.
- b. The OC 1 ATF Liaison Unit (LO BARIA) has operational control over all ranks of the unit. Flanking Formation LOs and Sub-Sector LOs are to command the members of their teams.

.../c. Technical

- c. Technical direction is to be exercised in the following ways:
  - (1) MILO and Intelligence Operations by GS02 (Int), and
  - (2) Arty Team by CO 12 Fd Regt.

5. In an operational emergency all teams are to come under the operational control of the senior officer commanding operations in each respective area.

- a. Flanking Formation Teams - Commander of Formation to whom attached,
- b. Sector Team: Arty Team and MILO - LO BARIA, and
- c. Sub-Sector Teams - District Senior Advisor.

6. Tasks

a. Flanking Formation Liaison Teams -

- (1) Provide liaison on operational matters, clearances and visits between HQ 1 ATF and Flanking Formations.
- (2) Assist 1 ATF in the collection of operational intelligence within the TAOI and to disseminate intelligence from 1 ATF sources to the formation to which the team is attached.
- (3) Provide continuous Radio Communications between the Flanking Formation and 1 ATF.

b. Sector Liaison Team (incl HQ) -

- (1) Provide liaison on any matters directed by GS02 (Ops) HQ 1 ATF between 1 ATF, PHUOC TUY Sector, MACCORDS Adv Team 89 and other organizations as detailed.
- (2) Provide Radio and Line Communication between Sector HQ and HQ 1 ATF.

c. Sector Artillery Liaison Team

- (1) To maintain a presence in the PHUOC TUY FSCC, and ensure that "Arty Tac" at NUI DAT is informed of any matter of interest to them.

d. Sub-Sector Liaison Teams

.../(1). Provide

(1) Provide liaison between HQ 1 ATF, Sub-Sector, DSA organization and 1 ATF battalions on operational matters or on matters as directed by GS02 (Ops) HQ 1 ATF.

(2) To assist HQ 1 ATF in the collection of operational intelligence.

7. Co-ordination Liaison teams are the direct representatives of Comd 1 ATF at HQs of flanking formations, US Advisory elms, Sector and Sub-Sector.

8. For local administrative and domestic matters, members of all teams are to conform to the routine practices of CORDS Advisory Teams.

9. Briefings.

a. On appointment all LOs are to report to HQ 1 ATF before assuming duty for briefing by GS02 (Ops) and GS02 (Int). The Co-ordination of such briefings is to be arranged through the GS03 (Ops).

b. All IO's are to attend the weekly briefing held at HQ 1 ATF at 1330 hrs each Saturday. They are to submit a verbal and written report in the form shown at Appendix B.

10. Administrative Matters

a. General. A Branch <sup>HQ 1 ATF</sup> is to control attachments and detachments to and from 1 ATF Liaison Unit. Current unit responsibilities to provide and administer detachments are shown at Annex A.

b. The Authority for movement is a 1 ATF Detachment Instruction, showing the period of the detachment and is the authority for ~~pay~~ payment of "Living Out of Saigon" Allowance.

11. HQ 1 ATF Liaison Unit is responsible for:

a. Arrangement of Quartering,

b. Pay and "Living Out of Saigon" Allowance, (with the exception of flanking forms),

c. NOTICAS duties (Sub-Sector LOs report to 1 ATF direct),

.../d. Stand-

RESTRICTED

- 4 -

- d. Stand-Down,
  - e. Disciplinary control. (Disposal of charges is the responsibility of OC HQ Coy).
  - f. Welfare (in conjunction with parent unit),
  - g. Reporting of accidents,
  - h. For ensuring that vehicle daily servicing is carried out and for ensuring that all vehicles are taken to HQ Coy compound weekly for inspection and period servicing.
12. Parent units are responsible for:
- a. RTA procedures,
  - b. R and R and R and C procedures,
  - c. Routine medical matters (e.g. injections),
  - d. Routine documentation,
  - e. Other unit admin. (Through Liaison Unit Admin NCO).
13. Changeover of Detached Personnel
- a. Personnel may be changed over at the request of parent units, or the LO BARIA, with the concurrence of HQ 1 ATF. As a guide, the minimum acceptable period of attachments is three months for LOs and Admin NCO, and one month for all others.
  - b. Requests for changeover are to be submitted to the GS02 (Ops) in the form shown at Appendix C, and are to be submitted at least one week before the desired changeover date. G Branch will coordinate with A Branch on the issue of a detachment instruction.
14. Q Matters. In accordance with HQ Coy 1 ATF Q Directives.

Other Detachments

15. Apart from a defoliation team formed as required by seasonal conditions, the following detachments are on a permanent basis.

- a. Det AFV Pro Unit NUI DAT. Garrison Military Police (West Gate) - (4)

.../b. Det AFV

AMENDMENT NO  
DATED JUL 71

RESTRICTED

RESTRICTED

- 5 -

- b. Det AFV PRO Unit, VUNG TAU. Town patrol and detention barracks -  
(10).
- c. Pearson Centre - (2).

AMENDMENT NO  
DATED JUL 71

RESTRICTED



RESTRICTED

APPENDIX A TO ANNEX I  
TO CH 1

DETACHMENTS FOR 1 ATF DUTIES  
(Reference 1 ATF SOPs Chap 1 Sect 5)

Serial (a)	Location (b)	Appointment (c)	Rank (d)	Unit to Provide (e)	Name (f)	Remarks (g)
1	Sector HQ	OC	Maj	HQ AFV	Maj R.J. FERRIER	Remains until RTA 28 Apr 72.
2	" "	MILO	Capt	Det 1 Div Int Unit	Capt M. ROBINSON	RTA 11 Mar 72 to be replaced by Det 1 Div Int Unit.
3	" "	Arty LO	Lt	12 Fd Regt	Lt T.L. NOLAN	To be replaced by 12 Fd Regt as required.
4	" "	RD NCO	WO/Sgt	1 ARU	Wos W.B. STEWART	1 ARU RFT NCO. Remains until RTA 23 Sep 71.
5	" "	Admin Sgt	Sgt	12 Fd Regt	Sgt K. TUCKER	RTA Oct 71. Replaced by 12 Fd Regt.
6	" "	Sigs (4)	Gnr	12 Fd Regt		
7	" "	Dvr/Storeman(2)	Pte	HQ Coy		
8	XUYEN MOC	LO	Capt/Lt	A Sqn 3 Cav Regt	Lt J. BODDINAR	Remains until RTA 27 Oct 71. Relieved on 24 Oct by offr from 3 RAR (see serial 25).
9	" "	Sig	Sig	104 Sig Sqn		
10	" "	Interpreter		Det 1 Div Int Unit		
11	DUC THANH	LO	Capt/Lt	C Sqn 1 Armd Regt	WO2 J.P. MURPHY	May require reallocation when C Sqn is disbanded about 30 Sep 71.
12	" "	Sig	Sig	104 Sig Sqn		
13	" "	C1 Op	Sgt	Det 1 Div Int Unit		
14	" "	Interpreter		Det 1 Div Int Unit		
15	LONG LE	LO	Capt/Lt	4 RAR/NZ(ANZAC)	Lt M.D. O'NEILL	RTA date 1 May 72. May be rotated by 4 RAR.
16	" "	Sig	Sig	104 Sig Sqn		
17	" "	C1 Op	Sgt	Det 1 Div Int Unit		
18	" "	Interpreter		Det 1 Div Int Unit		
19	DAT DO	LO	Capt/Lt	A Sqn 3 Cav Regt/ 3 RAR	Capt P. KOSENKO	3 RAR propose replacement on 31 Jul with Capt T.J. JACKSON
20	" "	Sig	Sig	104 Sig Sqn		
21	" "	Interpreter		Det 1 Div Int Unit		

RESTRICTED

AMENDMENT NO  
DATED JUL 71

RESTRICTED

- 2 -

Serial (a)	Location (b)	Appointment (c)	Rank (d)	Unit to Provide (e)	Name (f)	Remarks (g)
22	BIEN HOA	LO	Capt/Lt	1 Fd Sqn	Lt H.J. PARUSEL	RTA 16 Sep 71. To be replaced by 1 Fd Sqn.
23	3rd Bde 1st (US) Cav Div	Sigs (3)	L/Cpl/ Sig	104 Sig Sqn		
24	BEARCAT (RTAVF)	LO	Capt/Lt	4 RAR/NZ(ANZAC)	Lt M.C. HARRIS	Continuing responsibility of 4 RAR to provide.
25	" "	Sigs (3)	L/Cpl/ Sig	104 Sig Sqn		
26	XUAN LOC (LONG KHANH) Sector)	LO	Capt/Lt	3 RAR/A Sqn 3 Cav Regt	Capt L. O'DEA	R&R 10-24 Aug. To be replaced by 7 Aug by 3 RAR. Responsibility for XUAN LOC changes to A Sqn 3 Cav Regt on 24 Oct. (see serial 6).
27	" "	Sigs (3)	L/Cpl/ Sig	104 Sig Sqn		
28	NUI DAT Det AFV Pro Unit	Garrison Military Police	Gnr	12 Fd Regt		
29	" "	" "	Spr	1 Fd Sqn		
30	" "	" "	Pte	3 RAR		
31	" "	" "	Pte	4 RAR/NZ(ANZAC)		
32	Pearson Centre	Assistant	Tpr/ Cfn	A Sqn 3 Cav Regt		
33	" "	Supervisor	Sgt	HQ Coy		
34	VUNG TAU AFV ProUnit	MP duties	Gnr	12 Fd Regt		
35	" "	" "	Cpl	1 Fd Sqn		
36	" "	" "	Cpls	17 Const Sqn		
37	" "	" "	Cpl	17 Const Sqn		
38	" "	" "	Cpl	3 RAR		
39	" "	" "	Pte	3 RAR		
40	" "	" "	Cpl	4 RAR/NZ(ANZAC)		
41	" "	" "	Cpl	4 RAR/NZ(ANZAC)		
42	" "	" "	Pte	4 RAR/NZ(ANZAC)		

AMENDMENT NO  
DATED JUL 71

RESTRICTED

RESTRICTED

BI1-1

APPENDIX B  
TO ANNEX I  
TO CHAPTER 1

1 ATF LIAISON OFFICER'S REPORT

FOR PERIOD .....TO .....

SUBMITTED BY .....

1. Any changes in key staff?
  
2. Changes in Unit/Sub Unit/MATTs locs and tasks?
  
3. Operations.
  - a. Forecast?
  
  - b. Current Details?
  
  - c. Results?
  
4. Other Events of Interest or Significance?

AMENDMENT NO  
DATED JUL 71

RESTRICTED

RESTRICTED

BI1-2

APPENDIX B  
TO ANNEX I  
TO CHAPTER 1

5. Intelligence.
  - a. En Ops?
  - b. Infiltrations?
  - c. Kidnapping, Abduction or Murders?
  - d. Hoi Chanh, PWs?
  - e. Payments of Tax to VC?
  - f. Phung Hoang Successes?

AMENDMENT NO  
DATED JUL 71

RESTRICTED

RESTRICTED

BI1-3

APPENDIX B  
TO ANNEX I  
TO CHAPTER 1

g. Known Recruitment by VC?

6. Evidence of Successful PsyOps?

a. En.

b. Friendly.

7. Civic Action.

a. VN.

b. FWMAF.

AMENDMENT NO  
DATED JUL 71

RESTRICTED

RESTRICTED

BI1-4

APPENDIX B  
TO ANNEX I  
CHAPTER 1

8. An overall comment on Int Reports for the previous week.

9. Liaison Problems encountered in District/Fmn.

.....  
(Date)

Signature

.....

Rank

.....

.....  
(Name in BLOCKS)

RESTRICTED

AMENDMENT NO  
DATED JUL 71

PROPOSED CHANGEOVER OF DETACHED PERSONNEL

\_\_\_\_\_ (Unit)

Reference: A. HQ 1 ATF SOPs Chapter 1 Annex I.

1. Approval is requested for the following changeover of detached personnel:

a. Currently detached:

Number:.....Rank:.....Name:.....

b. Location:.....

2. Proposed replacement:

Number:.....Rank:.....Name:.....

3. It is proposed to effect the changeover of the above personnel on:

Date:.....

(Signature).....

(Rank).....

(Appt).....

HQ 1 ATF USE ONLY

1. The above changeover is APPROVED/NOT APPROVED and detachment Instruction  
No. T is attached.

(H.C. FRANKLIN)  
Maj  
DAAG

Remarks:.....  
.....  
.....  
.....  
.....

-----  
AMENDMENT NO  
DATED JUL 71

# MESSAGE FORM

FOR COMM. OPERATIONAL USE

PRIORITY ACTION

PRIORITY INFO

DATE-TIME GROUP

MESSAGE INSTRUCTIONS

PRIORITY

PRIORITY

120300Z JUL 71

FROM:

IATF

ROUTE

CR

TO:

AFV

SECURITY CLASSIFICATION

INFO:

G3Ops, G2Ops

CONFIDENTIAL

ORIGINATOR'S NUMBER

ATTN G2 OPS (AFV)

OPS 1205

CANCELLATION OF AO

ONE (1) AO GIVEN TO 3 BDE IN TRAC SPECIAL AO

BOUNDED BY E 53-65 IN 93-95

CANCELLED AS AT 120200Z JUL 71

TWO (2) OTHER AOs NO CHANGE

PAGE 1 OF 1 PAGES	REFS TO MESSAGE	WRITER'S NAME	OFFICE	TEL. NO.
FILE REFERENCE 569/1/29	CLASSIFIED <input checked="" type="checkbox"/> YES <input type="checkbox"/> NO	ESMONDE	G2Ops	EB 10

FOR OPERATOR'S USE

RELEASING OFFICER'S SIGNATURE

R	DATE	TIME	SYSTEM	OPERATOR	D	DATE	TIME	SYSTEM	OPERATOR

*[Signature]*  
EADS  
698.



R810/1/22

13 Jul 71

HQ AFV

TRAINING AIDS - PROVISION BY CMHC

1. Capt F.R. FORD, OC Det 131 Div Loc Bty recently visited the Combined Material Exploitation Command (CMHC). There he saw many items of equipment which would be invaluable as training aids for artillery intelligence staffs at the School of Artillery.

2. He obtained numerous photographs and in discussion with the staff of CMHC was informed that certified inert examples of equipment would be made available by CMHC to the School of Artillery if a request were made through MACV.

3. Attached is a list of items which have been selected and HQ AFV is requested to submit a request to CMHC through MACV for provision of the equipments.

*B.A. McDonald*

(B.A. McDONALD)  
Brig  
Comd 1 ATF

For Information:

Det 131 Div Loc Bty

THIRTY SAMPLES OF EQUIPMENT  
FOR USE AS TRAINING AIDS

1. Rockets.

- a. Rocket propelled grenades:
  - (1) Chicom RPG 2 and Launcher
  - (2) Russian/Chicom RPG 7 and Launcher
  - (3) Chicom type 50
- b. Chicom 107 mm Rocket and Launcher
- c. Chicom 140 mm Rocket
- d. Chicom over calibre 140 mm Rocket
- e. Russian 122 mm Rocket, Carrying Bag, Launcher

2. Mortars.

- a. Chicom 60 mm M3 Mortar Round
- b. Chicom 82 mm Mortar Round
- c. Russian 82 mm Mortar Round
- d. Russian/Chicom 120 mm Round

3. Grenades.

- a. Soviet/Chicom antitank hand grenade, RPG 3 or RPG - 3T.

4. In addition any documentation on above and on Russian/Chinese Guns and Howitzers encountered in this theatre of operations.

RESTRICTED

R810/6/3A (S)

57  
Headquarters  
1st Australian Task Force  
NUI DAT

R810/6/3A (S)

B Jul 71

Distribution: List A (Less serial 4, 9, 12, 17-19, 23-33)

REPORT ON TRAINING OF PERSONNEL FOR  
SERVICE IN SVN

Reference: A. AFV R723/1/3 dated 9 Jul 71.

B. 1 ATF Trg 1126 of 250545Z Jun 71.

1. Attached as Annex A is a list of units in 1 ATF that are required to submit training reports.. Reports are to reach HQ 1 ATF by the fifth day of the month shown against the units listed.
2. The reports are to have a minimum security classification of restricted and five copies are to be forwarded to this HQ.

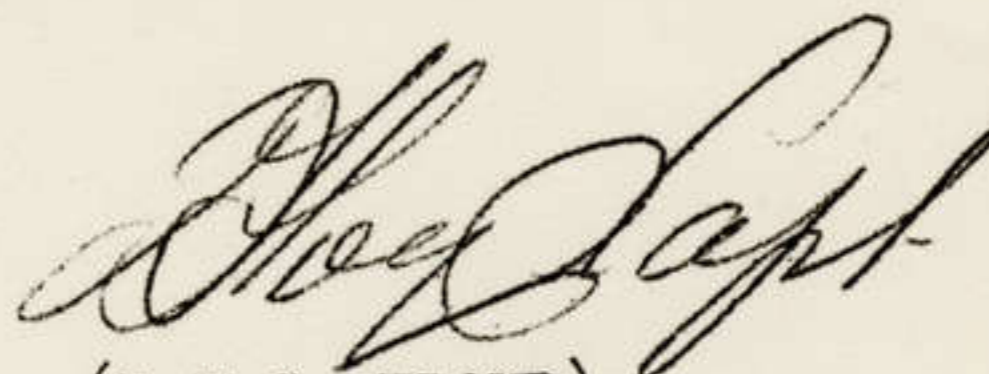

(D.T.G. FLOYD)  
Capt  
For Comd

Annex: A. List of Units in 1 ATF Required to Submit Training Reports.

RESTRICTED

UNITS REQUIRED TO SUBMIT TRAINING REPORTS

Serial (a)	Unit (b)	Months reports required	
		First Report (c)	Second Report (d)
1	C Sqn 1 Armd Regt incl LAD and Det 1 Fwd Del Tp.	Aug 71	_____
2	A Sqn 3 Cav Regt incl LAD.	Dec 71	Jun 72
3	12 Fd Regt RAA incl Det 131 div loc Bty and Wksp.	Aug 71	Feb 72 Excl Det 131 Div loc Bty
4	17 Const Sqn incl wksp	Dec 71	Jun 72
5	1 Fd Sqn incl wksp and 21 Eng Sp Tp.	Dec 71	Jun 72
6	104 Sig Sqn.	Dec 71	Jun 72
7	3 RAR	Jul 71	Jan 72
8	4 RAR/NZ(ANZAC)	Oct 71	Apr 72
9	2 SAS Sqn	Oct 71	Apr 72
10	1 ARU	Aug 71	Feb 72
11	161(Indep) Recce Flt	Jul 71	Jan 72
12	Det 1 Div Int Unit	Jul 71	Jan 72
13	8 Fd Amb incl Det 1 Fd Hyg Coy.	Oct 71	Apr 72
14	106 Fd Wksp incl stores sect.	Sep 71	_____
15	1 Aust CA Unit	Jul 71	Feb 72

ISOC-1-11

Jul 71

HQ AATF  
BARIATRAINING OF NO. 9  
USE OF AIRCRAFT AND EQUIPMENT

Reference: A. AATF BARIA memo dated 5 Jul 71.

1. No 9 Sqn RAAF is under the operational control of HQ 1 ATF and loading of aircraft must be approved by this HQ. An instruction in the above matters generally involves the use of aircraft, even if only on training side, then requests for training assistance should be directed in the first instance to HQ 1 ATF.
2. There is no objection to liaison direct with the Army Ground Liaison Officer with No 9 Sqn for planning of training or on details once approval has been given by this Headquarters.
3. GSO2 (Air) HQ 1 ATF will give any further information required.

(B. W. ROBERTSON)  
Major  
For Comd

BS10-6-3A (S)

4 Jul 71

HQ AFV (2)

REPORT ON TRAINING OF PERSONNEL FOR  
SERVICE IN SWI

Reference: A. HQ AFV H725/1/12 dated 9 Jun 71

1. Attached are copies of the training reports from 1 ATF as required.
2. Det 1 Div Int Unit have been advised of the correct method of submission of these reports.



(D.T.G. FLOOD)  
Capt  
for Comd

Inclosures: Training Reports from:  
a. 3 SAR  
b. 1 Aust CA Unit

TELEPHONE  
ESTATE



AUSTRALIAN MILITARY FORCES

C3(50) 810 6.3A (5)  
140

Quote in Reply

R798-1-1

ADDRESS

1 Aust CA Unit  
NUI DAT

Jul 71

HQ AFV

For Information:

HQ 1 ATF

REPORT ON TRAINING OF PERSONNEL FOR  
SERVICE IN AFV - 1 AUST CA UNIT

- References: A. HQ AFV R723-1-12 dated 9 Jun 71.  
B. 1 Aust CA Unit R798-1-1 dated 30 Apr 71.  
C. HQ AFV Engrs 8013 DTG 290635Z May 71 (Not to 1 ATF)

1. All training matters were covered fully in the report submitted on 30 Apr 71 (Reference B). There are no changes, or additional comments, to that report.
2. A request has been made for pre-SVN training on windmill erection and maintenance for the replacement Asst Supervisor construction and maintenance (Reference C). This is a "one time" requirement as the responsibility for this work will pass to the Vietnamese authorities in early 1972.

(L.A. WRIGHT)  
Lt Col  
CO

CONFIDENTIAL

R723/1/7

HQ 3 RAR  
Nui Dat

5 Jul 71

1 ATF (9)  
Comds Diary (3)  
File  
Spare

HALF YEARLY REPORT ON TRAINING  
OF PERSONNEL FOR SERVICE 1 AFV

Reference: A. HQ AFV R723/1/12 dated 9 Jun 71.  
B. 3 RAR R810/1/2 dated 1 May 71.

General

1. 3 RAR submitted half yearly report as Reference B. There is no change to that report except for the two additional points raised below.

Operation By Half Platoons

2. A concept of operating by half platoons has been developed within the theatre to meet particular tactical situations eg. detailed search of an area or ambushing. The half platoons are commanded respectively by the Pl Comd and Pl Sgt. To ensure that each half platoon remains a viable force the platoons equipment has been supplemented by one radio set and one GPMG (each ½ platoon thus having communications and two machine guns.)

3. Operating in half platoons requires some adaption of basic drills, as well as training of additional platoon signallers and machine gunners. This concept should be practiced in Australia during training.

Additional MFCs

4. Although the need for additional MFCs was recognised by the Unit in Australia, time and ammunition allocation prevented any personnel being trained.

5. Additional MFCs are required to provide observers for Sp Coy (if operating as a Coy) and for Aslt Pnr and Atk Pls. There are also many independant tasks and detachments which a Battalion is called upon to meet for which an observer is required. eg. Base patrolling, protection of NDPs, half platoon patrols etc. There is also no reserve within the Battalion to provide replacements for MFC battle casualties, injuries, sickness, R & R or even rest from operations. NCOs cannot be taken from the mortar line: the level of supervision and safety in this area is already a cause for concern.

6. This unit has trained four additional junior NCOs as observers in theatre.

7. The need for training observers should be reflected in such areas as AHQ schools and courses and annual ammunition allocation.

  
(F.P. SCOTT)

Lt Col  
CO



60

AUSTRALIAN ARMY

Headquarters  
1st Australian Task Force  
NUI DAT

R723/1/10

15 Jul 71

Distribution: See below

VC INSTALLATION REPORT

1. The format of the installation report contained at Appendix 6 to Annex D to chapter 1 of 1 ATF SOPs', is inadequate, in that it fails to provide enough detail or guidance on the information required.
2. Attached as Annex A is an amended version of the VC INSTALLATION REPORT, provided by courtesy of 1 Fd Sqn.
3. Addressees are requested to examine the attached Annex in the light of their requirements and submit any suggested amendments to the GS03 Ops by 18 July. Nil returns will be considered a concurrence with the new format of the amended report.
4. An amendment to 1 ATF SOPs' can be anticipated in the near future.

  
(E.P. ESMONDE)  
Capt  
GS03 Ops

Distribution:

1 Fd Sqn  
3 RAR  
4 RAR/NZ(ANZAC)  
C Sqn 1 Armd Regt  
A sqn 3 Cav Regt  
161 Recce Flt  
12 Fd Regt RAA  
SAS Sqn  
1 ARU  
Battle Int (G3)  
GS02 Ops  
GS03 Ops

ANNEX A TO  
R723/1/10  
DATED 15 JUL 71

VC INSTALLATION REPORT

- ALFA           1. Type of installation.  
              2. Date/Time of finding.  
              3. Callsign locating.
- BREVO          Location.
- CHARLIE       1. Size and shape of installation.  
              2. Number and size of pits, bunkers etc.  
              3. Thickness of OHP.  
              4. Entry/Exit routes.
- DELTA          1. Age of system.  
              2. Last used.  
              3. Condition of system.
- ECHO           1. Eqpt/stores located in system.  
              2. Method of disposal.
- FOXTROT       1. Mines/booby traps laid - type.  
              2. Where laid.  
              3. Method of disposal.
- GOLF           1. Was installation destroyed.  
              2. Method of destruction.  
              3. If not, when (est date/time).

CONFIDENTIAL  
AUSTRALIAN ARMY

Headquarters  
1st Australian Task Force  
NUI DAT

R6665/1/3

61  
/6 Jul 71

HQ AFV (2)

TRANSFER OF SENSOR DEVICES AND PUBLICATIONS

1. 1 ATF ceases Sensor activities on 31 Jul 71. Det 131 Div Loc Bty RAA has retained some examples of equipment that have been used during the programme as well as several publications concerning sensor equipments.
2. These examples will be forwarded to AHQ (D Sigs) via safe hand, with the returning EVA detachment.
3. Capt T.R. FORD, OC Det 131 Div Loc Bty RAA who has been Sensor Officer for 1 ATF for the last 11 months is posted to AHQ (Arty) from 30 Aug 71. He will be able to provide any information required on the devices.
4. Three of the devices are still usable. They should be handled with care as incorrect handling may disable these devices.
5. It would be appreciated if you would warn AHQ of the impending arrival of the devices.

*B.A. McDonald Col*

*B* (B.A. McDONALD)  
Brig  
Comd

For Information:

131 Div Loc Bty  
Spare (2)

CONFIDENTIAL

CONFIDENTIAL

ANNEX A TO  
1 ATF R6665/1/3  
DATED /6 JUL 70

INVENTORY

1. Equipment:

- a. One (1) Mini Siesmic Acoustic Intrusion Device (Minisid) - usable,
- b. One (1) Siesmic Hand Emplaced Acoustic Intrusion Device (SHAID) - disabled,
- c. One (1) Short SHAID - usable,
- d. One (1) Magnetic intrusion Device (MAGID) - usable.

2. Publications:

- a. User manual Radio Frequency Monitor set AN/USQ-42 (Portable),
- b. User manual Recorder Signal Data RO-376/USQ (Event Recorder),
- c. User manual Antenna group AN/USA-32 and Antenna AS-2549/USQ,
- d. Operating instructions for mast assembly AB1018,
- e. User manual detector anti intrusion (MAGID),
- f. Interim Technical Manual Short Air Deliverable Siesmic Intrusion Detector (ADSID),
- g. Technical manual Acoustic Siesmic Detection Transmitting Sets AN/GSQ-141 and AN/GSQ-142 (ACOUBOUY),
- h. Interimtechnical manual GSID-ID and charge 2,
- i. Technical manual Mini Handsid ID (MINISID),
- j. Sensor receiving Antenna handbook,
- k. Maintenance handbook ADSID III/S,
- l. Final report STANO III unattended Ground Sensor Combat Evaluation,
- m. MACV - Handbook Unattended Ground Sensor Management and utilization in SE Asia,
- n. DCPG paper "Duffle Bag in ten minutes",
- o. DCPG "Facts sheets",
- p. DCPG "Duffle Bag planning factors" - 2,
- q. HQ USARV Pam No 525-3 Employment of unattended ground sensors,
- r. DCPG Duffle Bag Planning Factors Phase III,
- s. Photographs - Total 39.

CONFIDENTIAL

MESSAGE FORM

FOR COM - COORDINATES USE

PRECEDENCE LETTER <b>PRIORITY</b>	PRECEDENCE INFO <b>PRIORITY</b>	DATE-TIME GROUP <b>170800 Z</b>	MESSAGE INSTRUCTIONS <b>(CP TO PASS TO HQ RAR BY SECURITY RADIO)</b> <b>JUL 71</b>
FROM: <b>IATF</b>	OR		
TO: <b>C SQN 1 ARMED REGT</b>	SECURITY CLASSIFICATION		
INFO: <b>12 FD REGT</b>	<b>SECRET</b>		
<b>4 RAR/NZ (ANZAC)</b>	DISTRIBUTION NUMBER		
<b>A SQN 3 CAN REGT</b>	<b>OPS 1229</b>		
<b>3 RAR</b>			

6 SQD 3 (OPS) 6 SQD 2 (INT) DARG DARG MC AREA TAC  
CP (PASS TO HQ RAR BY SECURITY RADIO)

CHANGE IN OPERATIONAL CONTROL 5 TP

C SQN 1 ARMED REGT (1)

ONE (1) TO BE EFFECTIVE FROM TIME OF RELEASE BY 12 FD REGT ON 18 JUL 71 CLN 5 TP FROM UNDER OP CON 12 FD REGT TO COME UNDER OP CON 4 RAR/NZ (ANZAC)

TWO (2) 12 FD REGT IS TO ADVISE HQ IATF OF RELEASE TIME

1 of 1 PAGES	REFS TO MESSAGE	SENDER'S NAME	ORIGIN	TEL. NO.
TIME REFERENCE	CLASSIFIED	<b>McFarlane</b>	<b>LS (OPS)</b>	<b>10</b>
	<input checked="" type="checkbox"/> <input type="checkbox"/> <input type="checkbox"/>			

FOR OPERATOR'S USE				RELEASING OFFICER'S SIGNATURE			
DATE	TIME	SYSTEM	OPERATOR	DATE	TIME	SYSTEM	OPERATOR
							<b>[Signature]</b>
							<b>NAME</b>

63

# MESSAGE FORM

RS69/1/10

FOR OPERATOR'S USE

PRECEDENCE ACTIVITY	PRECEDENCE INFO	DATE-TIME GROUP	MESSAGE DESCRIPTION
PRIORITY	PRIORITY	190200Z	JUL 71

FROM: 1 ATF

OR

TO: A SQN 3CAV REGT

SECURITY CLASSIFICATION

12 FD REGT

CONFIDENTIAL

4 RAR/NZ (ANZAC)

CONTINUING NUMBER

INFO: C SQN 1 ARMD REGT

OPS 1239

GSO(3) OPS DAAG DAQMG ALYTA

CP (PASS TO HQ 4RAR ON SECURE RADIO)

SECURITY FSB CHERIE 45 453907 @  
 REF 4 RAR OPO 4/71 OF 180150Z JUL 71 @  
 A SQN 3CAV REGT IS TO PROVIDE ONE SECT  
 FPCs FOR PROTECTION FSB CHERIE BY NI  
 WEF NI 20/21 JUL @ EXPECTED DURATION  
 OF TASK CMM FIVE TO SEVEN DAYS @  
 FOR 4RAR CLN THIS WILL ALLOW  
 TANKS IN BN RES TO BE REMOVED FROM  
 VICINITY CHERIE AT SHORT NOTICE

1 OF 1 PAGES	REFERENCES TO MESSAGE	DRAFTEE'S NAME	OFFICE	TEL. NO.
RS69/1/10	CLASSIFIED <input type="checkbox"/> YES <input type="checkbox"/> NO	McFALLAN	GSO(OPS)	ESOMY 10

FOR OPERATOR'S USE

RELEASING OFFICER'S SIGNATURE

DATE	TIME	SYSTEM	OPERATOR	DATE	TIME	SYSTEM	OPERATOR

*[Signature]*  
 RANK: Maj

64

MESSAGE FORM

R662/1/2

ALL COMM. CONSIDERED UNCL

PRECEDENCE-ACTION ROUTINE	PRECEDENCE INFO ROUTINE	DATE-TIME GROUP 200045 Z	MESSAGE INSTRUCTIONS JUL 71
FROM: I ATF			PERM OR
TO: AUSTFORER VIETNAM			SECURITY CLASSIFICATION RESTRICTED
INFO: 12 FD REGT			OPERATOR'S NUMBER OPS/242

PROVISION OF AA GUN CREWS TO JOHN MONASH  
 REF YOUR OPS 10559 OF 180140 Z JUL 71  
 NO SOLDIERS 12 FD REGT TRAINED ON  
 40 MM BATORS CMM SOME SMO: MAY HAVE  
 HAD TRG 0 HOWARD DUR MANPOWER  
 SIT CAUSED BY CURRENT AND CONTINUING  
 DEPLOYMENTS CMM REQUESTED NO  
 SOLDIERS CAN BE MADE AVAL

DATE 1 OF 1 PAGE	REFS TO MESSAGE	DEPARTING NAME	CHECK	REL. NO.
ALL REFERENCE	CLASSIFIED <input type="checkbox"/> NO <input type="checkbox"/> YES	M'FARLANE	CS(OPS)	ESOWY 10
FOR OPERATOR'S USE			RELEASING OFFICER'S SIGNATURE	
R	DATE	TIME	SYSTEM	OPERATOR
				D
				NAME McIn

AFR FORM 32

65

MESSAGE FORM

ROUTINE      ROUTINE      230700 Z JUL 71  
FROM:        † ATF  
TO:          AUSTFORCE VIETNAM

SECRET  
OPS 1234

SUMMER FALL CAMPAIGN PLAN . REF YOUR OPS †0482 OF 160401Z JUL 71 .

- ONE ! A CHECK OF OUR REGISTRY FILES CAN FIND NO TRACE OF THE MENTIONED PLAN OR CHANGES BEING RECEIVED AT THIS HQ !
- TWO ! NO COPY OF PLAN OR CHANGES HELD !
- THREE ! REQUEST COPY OF PLAN AND CHANGES BE FORWARDED THIS HQ IF AVAILABLE

PAGE 1 OF 1 PAGES      CLASSIFIED YES      ESMONDE GS03 (OPS)      EBONY 10

*Esmonde*  
CAPT



MESSAGE FORM

REG 9/11/66

FOR COMMUNICATIONS USE

PRECEDENCE CLASS	PRECEDENCE CODE	DATE-TIME GROUP	MESSAGE INDICATORS
ROUTINE		231315Z	JUL 71
FROM: IATF			PRIO: OR
TO: LO BARIA			SECURITY CLASSIFICATION
INFO: GSO 3 (OPS)			CONFIDENTIAL
			ORIGINATOR'S NUMBER
			OPS 1264

MISSION OF THE MISSION OF THE RVNAF  
 AND FNMAF IS TO ASSURE THE SECURITY  
 OF THE VIETNAMESE PEOPLE THROUGHOUT THE  
 REPUBLIC OF VIETNAM BY DEFEATING THE VC/NVA  
 FORCES AND BY PARTICIPATING IN THE SVN  
 PACIFICATION AND DEVELOPMENT PLAN (AUTH: TRAC)

NO. OF COPIES	COPIES TO MESSAGE	SENDER'S NAME	CLASS	TEL. NO.
1		McFARLANE	GSO 3 (OPS)	EDSON 10
FILE REFERENCE	CLASSIFIED	RELEASING OFFICER'S SIGNATURE		
	<input type="checkbox"/> UNCLASSIFIED	 NAME: McFarlane		
NO.	CLASS	INDEX OFFICER	CLASS	TIME
2		D		

REF FORM 52

MESSAGE FORM

ROUTINE ROUTINE 23 0100 Z JUL 71  
FROM: 1 ATF  
TO: 161 (INDEP) RECCE Flt  
547 SIG TP

67.  
R8400/1/11  
UNCLAS  
OPS 1261

ONE . AS A RESULT OF A US POST CRASH INQUIRY INTO AN ACCIDENT CMM  
RESULTING IN SERIOUS BURNS TO AVIATION PERSONNEL CMM DUE TO  
IMPROPER WEARING OF NOMEX FLIGHT CLOTHING CMM THE FOLLOWING  
DIRECTIVE IS REISSUED CMM AND IT IS TO BE OBSERVED BY PERSONNEL  
WEARING NOMEX CLOTHING WHEN ENGAGED IN FLYING ACTIVITIES .

ALFA . GLOVES ARE TO BE WORN .

BRAVO . SHIRTS ARE TO BE ZIPPED TO WITHIN TWO INCHES OF TOP .

CHARLIE . SHIRT IS TO BE TUCKED INTO TROUSERS AROUND THE  
WAIST AND A BELT WORN .

DELTA . SHIRT SLEEVES ARE TO BE DOWN AND SNUBBED OVER THE  
GLOVES .

ECHO . TROUSERS ARE TO BE SNUBBED AROUND ANKLES EITHER  
OVER BOOTS OR TUCKED SECURELY INTO BOOTS

PAGE 1 OF 1 PAGES CLASSIFIED NO ESMONDE GS03 (OPS) EBONY 10

  
CAPT

68  
MESSAGE FORM

ROUTINE

240500 Z JUL 71

CONFIDENTIAL

OPS 1266

FROM : 1 ATF  
TO : LIST A  
LIST C

NICKNAMES 1 ATF BASE DEFENSE AREAS OF OPERATION (AO'S) (.) 1 ARU BASE  
DEFENCE AO PREVIOUSLY NAMED JEANETTE CMM CURRENTLY NAMED LUGARNO CMM  
IS TO BE RENAMED PADDINGTON WITH EFFECT FROM 270800 HRS JUL 71 (.)  
THIS CHANGE IS REFLECTED ON LATEST REPRINT OF 1:50,000 CIVIL ACCESS  
OVERLAY

PAGE ONE OF ONE PAGES CLASSIFIED YES McFARLANE GS02 (OPS) EBONY 10

*McFarlane*  
CAPT

MESSAGE FORM

69

ROUTINE ROUTINE

250300 Z JUL 71

579/1/28

FROM : 1 ATF

UNCLAS

TO : LIST B (LESS SERIALS 4, 12, 24-33)

Q1009

CONTINGENCY PLANNING CMM UNIT MOVEMENT DATA TABLES (.) REF 1 ATF 579/1/57 OF  
6 JUL 71 (.) UNITS ARE REMINDED THAT THE LATEST ACCEPTABLE DATE FOR SUBMISSION  
OF MOVEMENT DATE TABLES TO HQ AFV IS 31 JUL 71 (.) RETURNS ARE NOT REQUIRED BY  
UNITS AFFECTED BY OP TIMOTHY

PAGE ONE OF ONE PAGES

PENNY

SC'Q'

EBONY 28

*B. Penny*

CAPT

7

CONFIDENTIAL  
AUSTRALIAN ARMY

Headquarters  
1st Australian Task Force  
NUI DAT

R739/1/1

25 Jul 71

Distribution: See below

ROUTE CLASSIFICATION

Reference: A. 1 ATF SOPs Chapter 2 Section 5.

1. With effect from 25 Jul 71 the classification of routes within the Province is:

a. Green

- (1) route 15,
- (2) route 2 from BARIA to YS463800,
- (3) route 23 from BARIA to YS500607,
- (4) route 44 from YS403598 to YS453490 and YS510525 to YS504556,
- (5) route 52,
- (6) route 327 from YS462776 to YS507775,
- (7) road - junction YS452584 to XA AN NHUT,
- (8) road - LONG DIEN to AP LONG THANH YS424573,
- (9) road - BARIA to bridge at YS381629,
- (10) road - HOA LONG to LONG DIEN, and
- (11) all roads within the BARIA - LONG DIEN complex.

b. Amber

- (1) route 2 from YS463800 to BLACKHORSE Camp,
- (2) route 23 from YS500607 to YS666678, and
- (3) route 327 from YS507775 to YS535770.

c. Red

- (1) route 44 from YS453490 to YS510525,
- (2) route 326 from YS452584 to YS504556,
- (3) route 327 from YS535770 - EAST,
- (4) route 328,
- (5) route 329, and
- (6) route 23 from YS666678 EAST to province border.

2. All units are to ensure that the precautionary measures applicable to each classification, as listed in reference A, are followed.

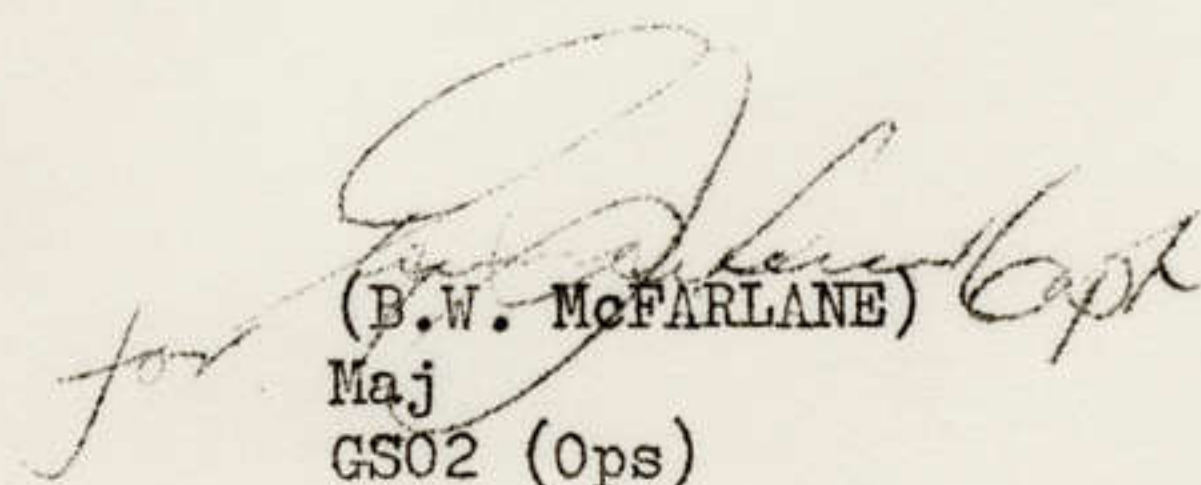
  
(B.W. McFARLANE)  
Maj  
GS02 (Ops)

Distribution:

List A; List C plus Aust LOs

CONFIDENTIAL

7

MESSAGE FORM

PRIORITY

28 1100 Z JUL 71

CONFIDENTIAL

FROM : 1 ATF

OPS1307

TO : LIST A LIST C

1 ATF OPERATIONS (.)

OPERATIONS HERMIT PARK AND HAWKER CONCLUDED 2400 HRS NI 27/28 JUL 71  
AND OPERATION IRON FOX COMMENCED AT THAT TIME (.) COMBAT OPERATIONS  
AFTER ACTION REPORTS ARE TO BE SUBMITTED BY INF BNS IN ACCORDANCE  
WITH 1 ATF SOPS, ANNEX D TO CHAPTER ONE SERIAL SEVEN

PAGE ONE OF ONE PAGES CLASSIFIED YES MC FARLANE GS02 (OPS)

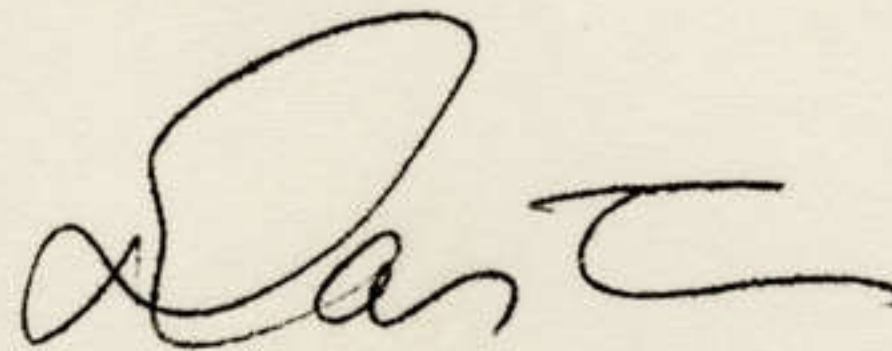

CAPT

MESSAGE

72

IMMEDIATE      ROUTINE      290200Z (JUL 71)

R617/1/5

FROM : 1 ATF

SECRET

TO : CG TRAC LBN

OPS1312

3RD BDE (SEP) 1ST (US) CAV DIV (AM) BIEN HOA

SPOT REPORT (.) REFERENCE OUR OPS1310 OF 290045Z (.) ENEMY OCCUPIED CAMP  
YS775882 (.) PATROL NOW ESTIMATES COMPANY SIZED CAMP (.) OCCUPANTS  
DRESSED IN GREEN UNIFORMS (.) REMAINS OCCUPIED THIS TIME (.) AIRSTRIKE  
REMAINS PLANNED FOR 291300H

PAGE 1 OF 1 PAGES CLASSIFIED YES MCFARLANE GS02 (OPS) EBONY 10

*M. Mathew*  
Capt MAJ

R544/1/12

30 Jul 71

HQ AFV

REPORT ON BARRIER MINEFIELD - BINH THUY

Reference: HQ AFV 544/1/1 of 3 Jun 71.

1. A detailed reconnaissance of the barrier minefield was carried out by 1 RL Sqn on 19 Jul 71.
2. Relevant information concerning the state of the minefield is as follows:
  - a. The northern section of the minefield is in heavy red soil, which is stable. The windrows and filled in slots left by the previous cleaning are undisturbed. There are no indications of mines.
  - b. The southern section is in sand or very sandy soil which is not stable. Wind and water erosion can and has moved the soil into configurations different from that which existed at the time of clearing. There is some evidence of mines in this section of the field.
  - c. There has been considerable movement of persons, cattle and vehicles across the minefield in all sections and portions of the northern section are covered by crops and padi.
  - d. No perimeter fences or warning signs exist. Either they were not erected in the first place, which seems most unlikely or they have been stolen. Recent experience has been that all such fences and signs erected have disappeared within a week.
3. It is concluded that:
  - a. the presence of surface mines in the northern section of the minefield is very remote and that this area is considered to be cleared to an acceptable degree;
  - b. the southern section of the minefield from 508560 to its southern end at 526540 could contain a number of surface mines and is not yet sufficiently cleared to an acceptable degree; and

.../c. it



c. it serves no useful purpose to fence or mark a mined or cleared area.

4. 1 ANZ will undertake mine-clearing operations in the southern portion of the barrier minefield with a view to improving its safety to an acceptable degree. It is expected that the task will be completed in approximately two months. It is not intended to fence or mark the minefield.

*B.A. McDonald*  
for (B.A. McDONALD)  
Brig  
Comd

MINUTE PAPER

74

---

LOSS OF SECURITY - BROADCASTS BY AASWCC

---

TFAC Rep  
Arty Tac  
OC 161 (Indep) Recce Flt  
GS02 (Air)

General

1. You are requested to examine the present method of warning aircraft of artillery firing with a view to changing the method so as not to require grids, from which artillery is firing and into which artillery is firing, to be broadcast in clear, thereby compromising locations and activities of the Task Force Artillery.

Authority for Present Method

2. It is appreciated that the present method is probably a standard theatre format for warning aircraft and that some authority probably exists for using this particular method. Is this inflexible? And how would higher Air and Land Headquarters react to a different method being used in Phuoc Tuy?

Alternative Methods

3. What type of alternative methods of warning are available? Two methods may be workable:
- a. encoding grids on the warning net, and
  - b. producing an encoded grid overlay for maps of the Province.

Both these methods however would be cumbersome and difficult to implement in view of the number of Non-Australian aircraft which fly in or transit through Province airspace below 3,000 ft.

Conference

4. It is requested that addressees examine the matter and be prepared to present preliminary findings on the matter at a conference with GS02 (Ops) on Tue 10 Aug at 1600 hrs. If any addressee can not attend at that time please advise GS02 (Ops) and another more suitable time will be negotiated.

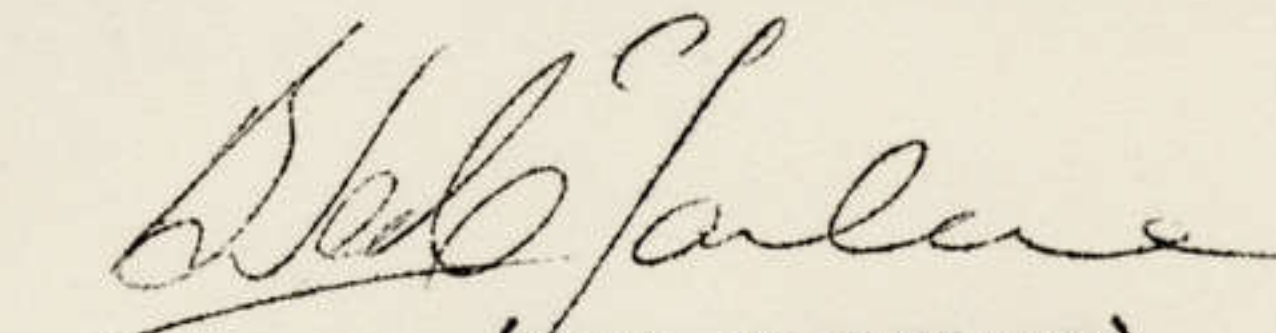
  
(B.W. McFARLANE)  
Maj  
GS02 (Ops)

30 Jul 71

AUSTRALIAN ARMY

15

R478/1/392

Headquarters  
1st Australian Task Force  
NUI DAT

31 Jul 71

Distribution: List A (Less serials 4, 24-33)

EXPLOSION IN AMMUNITION BUNKER  
V COY 4 RAR/NZ(ANZAC) BN

General

1. Following the investigation of the explosion in V Coy 4 RAR/NZ(ANZAC) Bn ammunition bunker the following points of general interest are reproduced from the Investigating Officers report.

Possible Cause of the Fire

2. A fire could have been started by any of the following:-
- a. Defective ammunition. A malfunction in a supposedly servicable round.
  - b. Carelessness on the part of the work party. A member may have been smoking in the bay or may have released a grenade.
  - c. A grenade may have had the pin removed and been inadequately taped. This may have occurred either in the bay, or the grenade could have been received from the field with the pin removed and the tape on.

Bunker Construction

3. The type of bunker employed at V Coy is shown at Annex A. This type of bunker proved to be highly effective considering the small amount of damage done to the surrounding constructions
4. The principle of internal isolation within the bunker also proved effective, as a large quantity of claymores were not detonated, and boxed SAA which provide a screen for more sensitive demolition stores were only slightly damaged.

Recommendation

5. It must be stressed that the safety pins are not to be removed from grenades even though the handles are taped to the grenade body. The tape must be regarded only as an additional safety measure. Should ammunition control personnel discover a grenade with the pin removed and the tape only holding the lever in place, they should, in the case of a HE grenade, treat it as an EOD item. In the case of all other types of grenades the item should be segregated and arrangements made for immediate disposal. Under no circumstances should such an item be placed with bulk stock.

6. The practice of leaving caps blasting crimped to the cortex used for joining claymore mines should be discontinued. The caps, with one inch of cord detonating should be cut from the leads on disassembling the claymore banks if the leads are to go into unit storage.

7. Retrograde ammunition must be inspected by an AT, and where applicable returned to the AP isolation bay as soon as possible.

Conclusion

8. Units are reminded that the services of:

- a. 1 ATF Fire Officer,
- b. Fire Service Inspector,
- c. Ammunition Technical staff,

are available for consultation if required, on matters relating to fire hazards, and ammunition storage.

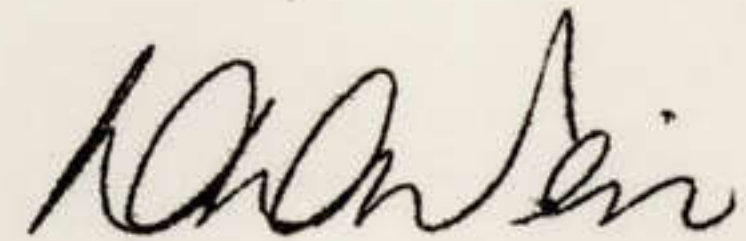

(D.D. WEIR)  
Col  
D Comd

ANNEX A TO  
1 ATF R478/1/392  
DATED 31 JUL 71

Walls are of three layers  
of sandbags held by corrugated  
iron and steel pickets.

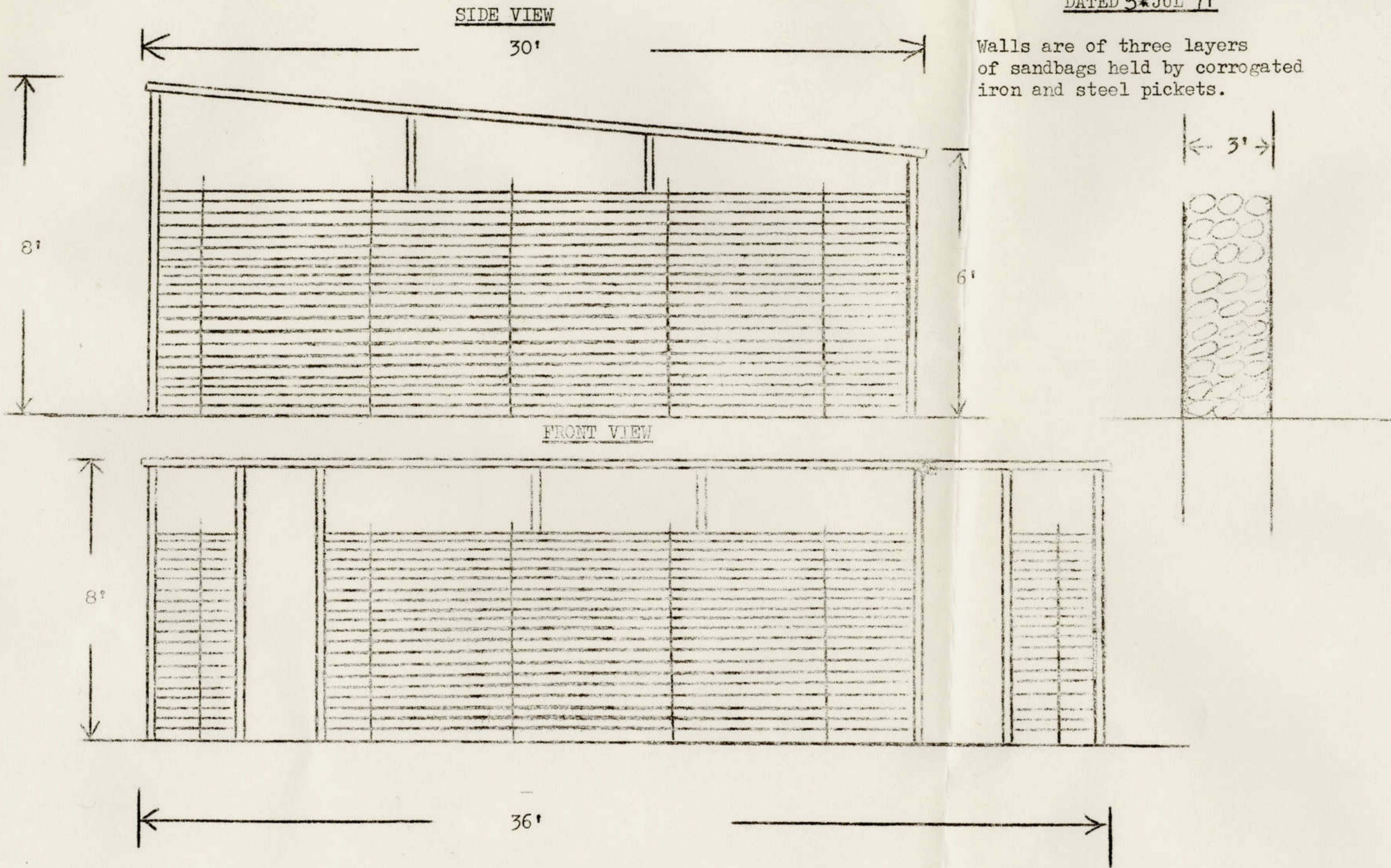

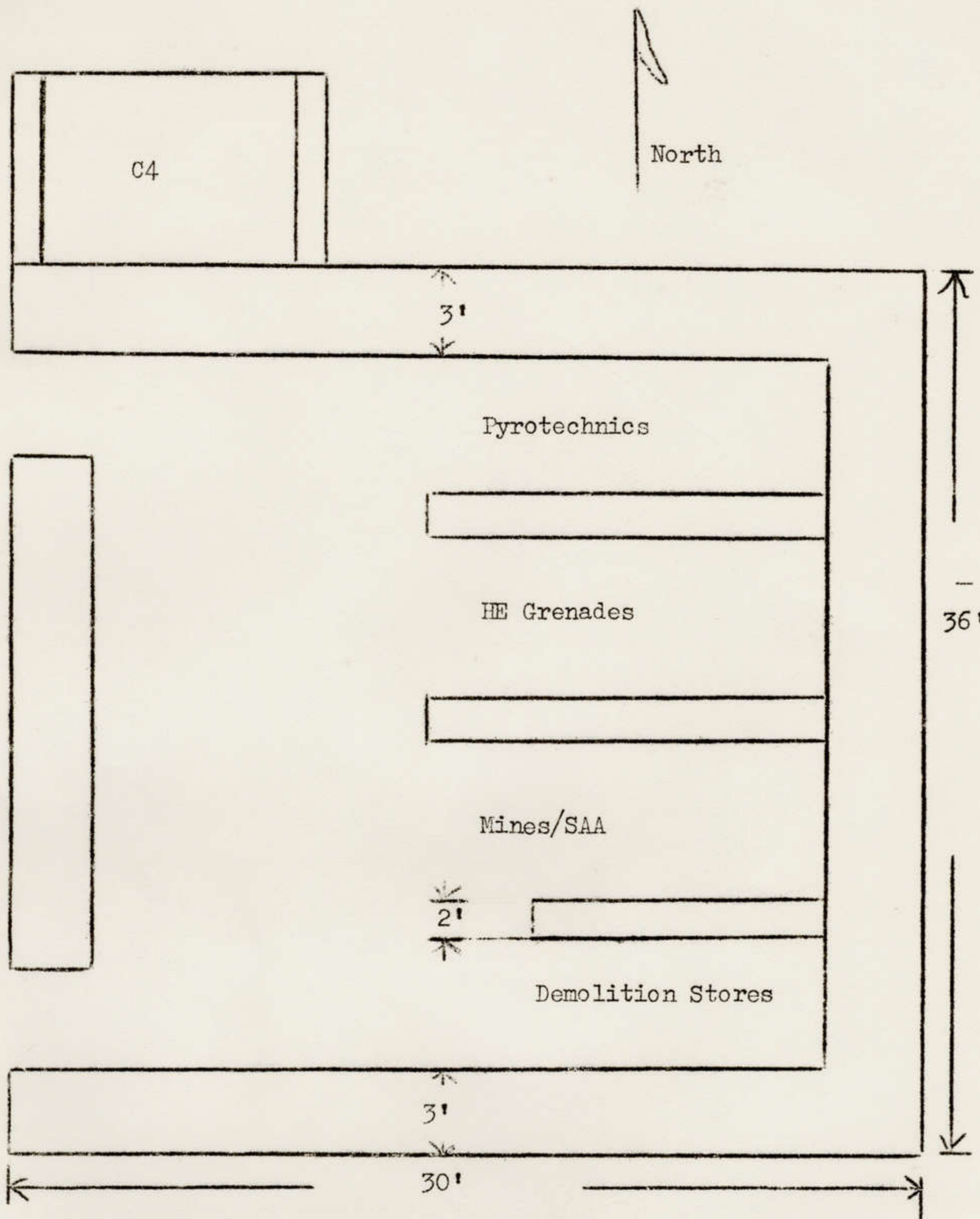

MESSAGE FORM

16

PRIORITY

0115300 (Z) JUL 71

R723/1/108

FROM : 1 ATF

SECRET

TO : AUSTFORCE VIETNAM

OPS 1154

RE OPS PHUOC TUY PROVINCE AS AT 2400 HRS 1 JUL 71 (.)

ALPHA (.) ONE (.) OPS CONTINUING AT APPROX SAME LEVEL IN AREAS OTHER THAN THOSE  
CON BY 1 ATF CLN AVERAGE OF ONE OP DAILY IN ATF CON AREAS (.)

TWO (.) 302 RF BN MAINTAINS PL IN SOUTHERN LONG/HAI WITH TWO COYS  
OP IN AREA EAST OF SOUTHERN LONG HAI (.)

BRAVO (.) ONE (.) OPS CONDUCTED MAINLY CLEARING LIMITED AREAS WITH UPTO THREE  
COYS DAILY USED FOR ROUTE CLEARANCE ON MAJOR ROUTES (.)

TWO (.) 578 RF COY CONDUCTED AIRMOBILE ASLT USING 18 ARVN DIV  
RESOURCES WHOLLY CREWED BY VN INTO 418529 ON 1 JUL 71 (.)

THREE (.) SIT RESULTING FROM SECTOR POLICY OF CONDUCTING AIRMOBILE  
OPS BECAUSE OF ASSETS AVAIL IS THAT TASKS ARE INVENTED IN AREAS  
WHERE ACCESS BY OTHER MEANS IS ENTIRELY POS (.)

CHARLIE (.) CHANGES IN LOCS CONSIDERABLE CLN NEW LOCSTAT FOR RF UNITS WILL BE FWD  
SEPERATELY (.)

DELTA (.) AS FOR CHARLIE (.)

ECHO (.) NIL (.)

FOXTROT (.) 3 COY 302 RF BN CONTACTED EN FORCE IN AMBUSH POSN AT 476490 AT 0910 HRS  
1 JUL 71 CLN EN FIRED SA AND 60 MM MOR CLN RESULTS 6 RF KIA 2 RF WIA 7  
M16s LOST CIN EN LOSSES UNKNOWN (.)

GOLF (.) NIL NOTIFIED (.)

HOTEL (.) NO CHANGE

PAGE ONE OF ONE PAGES

CLASSIFIED: YES

FERRIER AUST LO BARIA

*[Handwritten signature]*  
Capt

MESSAGE FORM

PRIORITY ROUTINE

09 Z JUL 71

11  
R723/1/108

SECRET

OPS1190

FROM 1 ATF  
TO AUSTFORCE VIETNAM

RF OPS PHUOC TUY PROVINCE AS AT 2400 HRS 8 JUL 71 .

ALPHA : ONE : DONG KHOI PHASE SIX CURRENTLY BEING PLANNED CLN OTHER OPS CONT AT  
APPROX SAME LEVEL .

TWO : 302 RF BN MAINTAINS PL IN SOUTHERN LONG HAI'S WITH CHANGEOVER ROUTE  
WHICH WAS SCENE OF LAST WEEK'S AMBUSH STILL BEING USED CLN TWO COYS 302 RF  
BN STILL OP IN AOs EAST OF SOUTHERN LONG HAI'S .

BRAVO : ONE : RF COYS STILL BEING USED ON DAILY ROUTE CLEARANCE IN XUYEN MOC AND  
LONG LE DISTRICTS WITH PF PLS ASSUMING THIS RESPONSIBILITY IN OTHER  
DISTRICTS .

TWO : 955 RF COY CONDUCTED AIR MOBILE ASLT USING 18 ARVN DIV RESOURCES  
CREWED WHOLLY BY VN PERS INTO 527712 ON 7 JUL 71 CLN INSERTION WELL  
CONDUCTED BUT NIL RESULTS FROM OP .

THREE : OPS STILL BEING PLANNED ONLY BECAUSE AIR ASSETS AVAL .

CHARLIE : RF COY LOCSTAT ISSUED BY SECTOR AS AT 30 JUN 71 SHOULD BE AMENDED AS  
FOLLOWS CLN 3/47 GP HQ LOC LONG MY 493555 CMM 701 RF COY REMAINS HOI MY  
503557 .

DELTA : NO CHANGE .

ECHO : NO CHANGE .

FOXTROT : ONE : NIL CLN SEE INTSUMS FOR FURTHER DETAILS .

TWO : AMEND 3 COY 302 RF BN CONTACT 1 JUL 71 CLN DELETE 2 RF WIA INSERT  
1 RF WIA .

GOLF : DONG KHOI PHASE SIX TO COMMENCE SHORTLY .

HOTEL : NO CHANGE

PAGE ONE OF ONE PAGE CLASSIFIED YES FERRIER AUST LO BARIA

*Ferrier*  
Kaj



18

MESSAGE

PRIORITY ROUTINE

230030ZUL 71

R723/1/108

FROM: 1 ATF

TO: AUSTFORCE VIETNAM

SECRET

OPS1258

RF OPS PHUOC TUY SECTOR AS AT 2400 HRS THU 22 JUL 71 .

ALFA . ONE . DONG KHOI PHASE VI COMPLETED 0800 HRS 22 JUL CLN NO TANGIBLE RESULTS .

TWO . 302 RF BN MAINTAINS TWO RF COYS IN AOS EAST OF SOUTHERN LONG HAIS .

BRAVO . ONE . AIRMOBILE INSERTION CONDUCTED BY 578 RF COY 455620 USING 18 ARVN DIV RESOURCES ON 19 JUL .

TWO . 771 RF COY CO-OP WITH 3 RAR IN AREA NORTH AND NORTHWEST OF NUI NHON 5863 ON 21-22 JUL CLN 609 RF COY CO-OP WITH 3 RAR IN SAME AREA ON 22-23 JUL CLN BOTH UNITS ON SEARCH SWEEPS IN CONJUNCTION WITH 3 RAR OPS .

THREE . 612 RF COY CO-OP WITH 3 RAR IN AREA NORTH AND WEST OF XUYEN MOC DURING PERIOD 17-22 JUL 71 .

CHARLIE . 615 RF COY NOW LOC LONG MY 493555 CLN 576 RF COY NOW LOC PHUOC HOA LONG 490585 CLN 586 RF COY NOW LOC PHUOC HAI 515536 CLN ALL MOV EFFECTIVE 22 JUL .

DELTA . NO CHANGE .

ECHO . NO CHANGE .

FOXTROT . NIL . SEE INTSUMS FOR OTHER DETAILS .

GOLF . TWO AIRMOBILE INSERTIONS PLANNED FOR NEXT WEEK .

HOTEL . NO CHANGE

PAGE ONE OF ONE PAGES

CLASSIFIED YES

FERRIER MAJ

  
CAPT

MESSAGE FORM

PRIORITY ROUTINE 30 1600 Z JUL 71  
FROM: 1 ATF  
TO: AUSTFORCE VIETNAM

19  
R723/1/108  
SECRET  
OPS1315

RF OPS PHUOC TUY SECTOR AS AT 2400 HRS THU 29 JUL 71 (.)

ALFA (.) ONE (.) OPS CONTINUE AT APPROX SAME LEVEL AS DURING  
DONG KHOI PHASE VI CLN PLANS FOR DONG KHOI VII  
NOT YET ANNOUNCED (.)

TWO (.) 302 RF BN MAINTAINS TWO COYS IN AOS EAST OF  
SOUTHERN LONG HAI (.)

BRAVO (.) ONE (.) AIR MOBILE INSERTION CONDUCTED BY 655RF COY  
25 JUL INTO YS520840 CMM 4 COY 302 RF BN 25 JUL  
INTO YS525669 CMM 612 RF COY 29 JUL INTO YS633781  
CLN AIR ASSETS PROVIDED BY NO 9 SQN RAAF AFTER  
18 ARVN DIV UNABLE TO PROVIDE CLN CO NO 9 SQN  
STATES THAT STANDARD OF TRG IN THIS TYPE OF OP  
WAS GOOD FROM RAAF POINT OF VIEW (.)

TWO (.) 609 RF COY CONTACTED 5 VC YS551648 24 JUL CMM NO  
CAS KNOWN CLN DOCUS IDENT MEMBER C1/D445 CIA PLUS  
2 WPNS (.)

THREE (.) 124 RF COY CONTACTED 5 VC YS447578 25 JUL CMM  
RESULT OF MECH AMBUSH AND SUBSEQUENT FOLLOW UP  
2 VC KIA CMM IDENTIFIED AS COMD AND 2IC OF LONG  
DIEN GUERILLA UNIT CLN COMD OF UNIT BELIEVED TO  
HAVE PLANNED THE ABDUCTION IN MAY OF 19 PSDF FROM  
LONG DIEN MARKET (.)

CHARLIE (.) NO CHANGE (.)  
DELTA (.) NO CHANGE (.)  
ECHO (.) NO CHANGE (.)  
FOXTROT (.) SEE BRAVO AND INTSUMS (.)  
GOLF (.) CONTINUE OPS IN PRESENT AOS (.)  
HOTEL (.) NO CHANGE

PAGE 1 OF 1 PAGES CLASSIFIED YES FERRIER LO BARIA

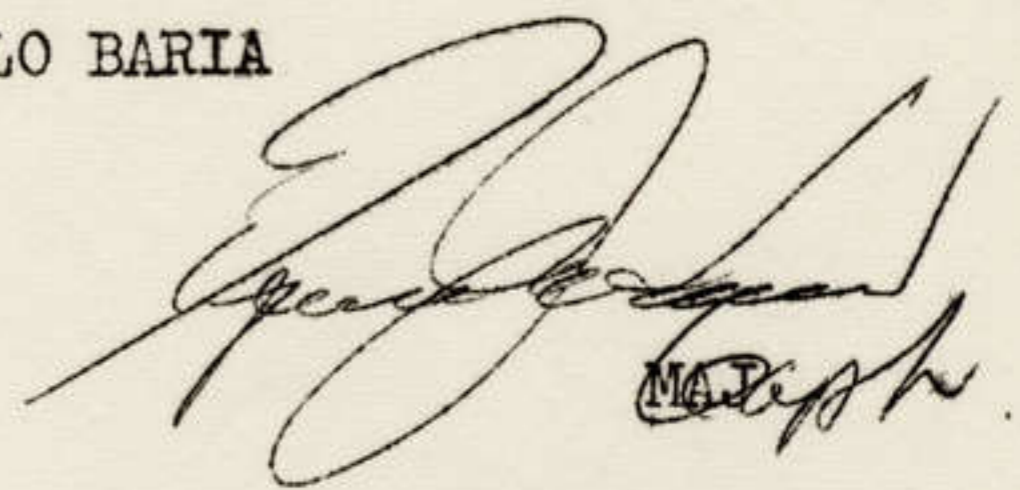

80

# MESSAGE FORM

FOR COMMUNICATIONS USE

PRECEDENCE ACTION <b>PRIORITY</b>	PRECEDENCE INFO <b>ROUTINE</b>	DATE-TIME GROUP <b>131500Z</b>	MESSAGE INSTRUCTIONS
FROM: <b>1 ATF</b>			PERFL <b>GR</b>
TO: <b>HQ TRAC</b>			SECURITY CLASSIFICATION <b>CONFIDENTIAL</b>
INFO: <b>G3Cps, G2Cps,</b>			ORIGINATOR'S NUMBER <b>OPS 1209.</b>

ATTN: MACTR - G3CP (.)  
 YELLOW JACKET OPERATIONAL SUMMARY (.)  
 LINE REPORTING PERIOD 062400H TO 13 -  
 -2400H (.)  
 TWO ALL SERIALS NIL RETURN (.)

PAGE <b>1</b> OF <b>1</b> PAGES	EXITS TO MESSAGE	DRAFTEE'S NAME	OFFICE	SER. NO.
FILE REFERENCE	CHARGED <input checked="" type="checkbox"/> YES <input type="checkbox"/> NO	<b>ESMONDE G(ops) EB10</b>		
FOR OPERATOR'S USE				RELEASING OFFICER'S SIGNATURE
<b>R</b>	DATE	TIME	SYSTEM	OPERATOR
				<b>D</b>
				<i>[Signature]</i>

ELT FORM 52

81

T HH

OO UUMSB

DE UUMSBD 042 1960236

ZNY SSSSS

O 150230Z JUL 71

FM 1 ATF

TO CG TRAC LBN SVN

BT

S E C R E T OPS 1220. YELLOW JACKET OPERATION.

ONE. CATEGORY ALFA RESPOSE IN EFFECT.

TWO. USUALLY RELIABLE SOURCE REPORTS PRESENCE D445 PROVINCIAL BATTALION IN VICINITY YS5966 LATE PM 14 JUL AND IN GENERAL VICINITY YS6269 MORNING 15 JUL 71. AUST EVALUATION IS BRAVO TWO.

THREE. REDEPLOYMENT 3 RAR AND SUPPORTING CAVALRY TROOP AND ELEMENTS OF 12 FD REGIMENT ARE CURRENTLY TAKING PLACE WITH A VIEW TO DESTROYING D445 BATTALION AND SHIELDING XUYEN MOC YS6568 AND SURROUNDING FRIENDLY LOCATIONS.

FOUR. 4 RAR/NZ (ANZAC) REMAINS IN CLOSE VICINITY SUSPECTED LOCATIONS HQ 274 (VC) REGT AND 1ST BN 274 REGT AND WILL CONTINUE OPERATIONS IN PRESENT LOCATION

BT

NNNN

Cummins Deary

19/7  
630pm

S2

HH

PP RAMARL  
DE RAMABC 009 2000200  
ZNY SSSSTEIUNX 190200Z JUL 71  
FM 1 ATF  
TO ZEN/CG TRAC LBN SVN  
INFO RAMARL/AUSTFORCE VIETNAM  
BT

S E C R E T OPS1238. ATTN G3 OPS. YELLOW JACKET OPERATION.

ONE. CATEGORY ALFA RESPONSE TO COMMENCE 20 JUL 71

TWO. USUALLY RELIABLE SOURCE REPORTS PRESENCE OF HQ 274 (VC)  
REGIMENT IN GENERAL VICINITY (YS4095) ON 18 JUL. AUST.

EVAL B2.

THREE. REDEPLOYMENT OF 4 RAR/NZ (ANZAC) SUPPORTING CAVALRY  
TROOP AND ARTY ELEMENTS OF 12 FD REGIMENT AND C BTY 5/42 (US) ARTY  
TAKING PLACE WITH A VIEW TO DESTROYING HQ 274 (VC) REGIMENT.

FOUR. 3 RAR REMAINS IN GENERAL VICINITY WEST OF XUYEN MOC (YS6166)  
TARGETED AGAINST D445 BATALION CMM AND SHIELDING XUYEN MOC AND  
SURROUNDING FRIENDLY LOCATIONS. TO DATE NO SIGNIFICANT RESULTS  
BT

NNNN

MESSAGE FORM

83

FOR COM1 CRYPTONETS USE

PRECEDENCE-ALPHA <b>PRIORITY</b>	PRECEDENCE INFO <b>PRIORITY</b>	DATE-TIME GROUP <b>210800Z Jul 71</b>	MESSAGE INSTRUCTIONS <b>CR</b>
FROM: <b>IATF</b>			SECURITY CLASSIFICATION <b>SECRET</b>
TO: <b>HQ TRAC</b>			
INFO: <b>G3 Ops (IATF) AUST FORCE VIETNAM</b>			
			ORIGINATOR'S NUMBER <b>ops 1249</b>

**ATTN G3 OPS (1)**  
**YELLOW JACKET WEEKLY OPERATIONAL SUMMARY (1)**  
**ONE (1) TWO (1)**  
**ALFA (1) TWO**  
**BRAVO (1) NIL**  
**TWO (1) ALFA (1)** USUALLY RELIABLE SOURCE CMM AUST EVAL B2 CMM ON  
 14-15 JUL REPORTED PRESENCE DM45 PROVINCIAL BN  
 IN GENERAL VICINITY YS5966 (1) 3RAR DEPLOYED 15 JUL  
 TO AREA WEST OF XUYEN MOC (YS6568) TARGETED AGAINST  
 DM45 BN (1) RESULTS 9VC KIA (BC) CMM, IDENTIFIED AS  
 MEMBER RECCE ELEMENT DM45 BN (1) OPERATION CONTINUING  
**BRAVO (1)** USUALLY RELIABLE SOURCE CMM AUST EVAL B2 CMM ON  
 18 JUL REPORTED PRESENCE HQ 274 VC REGIMENT

PAGES 1 OF 3 PAGES FILE REFERENCE	REFERRED TO MESSAGE CLASSIFIED <input checked="" type="checkbox"/> YES <input type="checkbox"/> NO	DRAFTER'S NAME GRADE TEL. NO.	RELEASING OFFICER'S SIGNATURE
PDB OPERATOR'S USE		OPERATOR'S SIGNATURE	
R	DATE TIME SYSTEM OPERATOR	OPERATOR	

REF FORM 52

# MESSAGE FORM

FOR COMMUNICATIONS USE

PRECEDENCE ACTION <b>PRIORITY</b>	PRECEDENCE INFO <b>PRIORITY</b>	DATE-TIME GROUP <b>210800Z JUL 71</b>	MESSAGE INDICATOR <b>FRESH</b>
FROM :			<b>CR</b>
TO :			SECURITY CLASSIFICATION
INFO :			<b>SECRET</b>
<del> </del>			ORIGINATOR'S COMMAND

IN GENERAL VICINITY YS 4095 (1) 4RAR/NZ/ANZAC)  
 DEPLOYED GENERAL AREA YS4095 ON 19 JUL TARGETED  
 AGAINST HQ 274 REGIMENT CMM BNCURRENTLY SEARCHING  
 WEST GENERAL VICINITY YS3693 (2) RESULTS IVC KIA (BC)  
 CMM IDENTIFIED AS MEMBER FROM C23 SURGICAL COY  
 OF 274 VC REGT (2) OPERATION CONTINUING (2)

PAGE <u>2</u> OF <u>2</u> PAGES	REFERS TO MESSAGE	DRAFTER'S NAME	CWIC	RC. NO.
FILE REFERENCE	CLASSIFIED <input checked="" type="checkbox"/> YES <input type="checkbox"/> NO	<b>ESMONDE</b>	<b>40ps</b>	<b>E610.</b>
FOR OPERATOR'S USE			RELEASING OFFICER'S SIGNATURE	
E	DATE	TIME	SYSTEM	OPERATOR

RLY FORM 53

MESSAGE FORM

IMMEDIATE ROUTINE 270900 Z JUL 71

84  
R569/3/35

FROM: 1 ATF

CONFIDENTIAL

TO: CG TRAC

OPS 1299

ATTN G3 OPS .

YELLOW JACKET OPERATION !

- ONE . CATEGORY A RESPONSE TO COMMENCE 28 JUL 71 .
- TWO . USUALLY RELIABLE SOURCE REPORTS PRESENCE OF 1 BATTALION  
274 (VC) REGIMENT IN GENERAL VICINITY YS 4091 ON 26 JUL 71 .  
AUST EVAL B2 .
- THREE . REDEPLOYMENT OF 3 RAR CMM A SQN 3 CAV REGT AND ARTY ELEMENTS  
OF 12 FIELD REGIMENT TAKING PLACE CMM WITH A VIEW TO FORMING  
A BLOCKING POSITION ASTRIDE THE SUOI CA RIVER ALONG A GENERAL  
LINE YS 3992 TO YS ~~3990~~ TO YS 4089 TO YS 4290 . FSB KATE  
WILL BE ESTABLISHED AT YS 4288 ON 28 JUL !
- FOUR . REDEPLOYMENT OF 4 RAR/NZ (ANZAC) AND C SQN 1 ARMD REGT (-)  
TAKING PLACE . 4 RAR/NZ (ANZAC) MOVING GENERAL VICINITY OF  
YS 4293 TO POSITION ITSELF FOR ATTACK SOUTH WEST TOWARDS  
SUSPECTED LOCATION OF 1 BATTALION 274 REGIMENT ON 28 JUL .  
C SQN 1 ARMD REGT (-) IN LOCATION AT YS 4094 UNDER OPERATIONAL  
CONTROL 4 RAR/NZ (ANZAC) FOR ATTACK FORCE ON 28 JUL !

PAGE 1 OF 1 PAGES CLASSIFIED YES ESMONDE GS03 (OPS) EBONY 10

  
CAPT



AUSTRALIAN ARMY

85

Headquarters  
1st Australian Task Force  
NUI DAT

R579/1/63

H Jul 71

3 RAR  
4 RAR/NZ(ANZAC)

For Information:

A Sqn 3 Cav Regt

REORGANISATION - A SQN 3 CAV REGT

Reference: A. A Sqn 3 Cav Regt R579/1/2 dated 1 Jul 71.

1. A copy of Reference A is enclosed.
2. Battalions are requested to study the proposal and comment on:
  - a. whether two or three of the vehicles in an AMC sect should be M125 A1s, and
  - b. if it would be acceptable to only have one RAAC crewman per vehicle in a mortar fire support base.
3. With reference to paragraph 5 of Reference A, it may also be possible for additional crew to be provided for larger moves from perhaps the Ready Reaction Force Troop or Squadron Headquarters. A further thought is that the section commander could remain with the sect but additionally look after a vehicle himself thereby keeping the total number of cavalrymen on the ground at only three.
4. The retention of an additional section of APCs on operations is attractive and any concession which can be made to allow this, providing all aspects of security of the vehicles and their position are covered, is very desirable.
5. It is requested that Battalions' comments be advised, by phone will do, to GS02 (Ops) as soon as practicable.



(B.W. McFARLANE)  
Maj  
GS02 (Ops)

Enclosure: 1. Reference A.

# MESSAGE FORM

86

FOR COMA GEN/SIGNALS USE

PRECEDENCE ACTION <b>PRIORITY</b>	PRECEDENCE INFO	DATE-TIME GROUP <b>080640 Z JUL 71</b>	MESSAGE INSTRUCTIONS
FROM: <b>1 ATF</b>			PREFIX <b>CR</b>
TO: <b>AUSTFORCE VIETNAM</b>			SECURITY CLASSIFICATION <b>SECRET</b>
INFO: <b>A SQN 3CAV</b>			ORIGINATOR'S NUMBER
<b>1 ALSG</b>			<b>SD 1191</b>
<b>2 AOD</b>			

OP TIMOTHY O RETURN OF M113 VEHs O YOUR SD 10044  
 OF 071010 JUL 71 O ONE O FIRST FOUR FSVs HAVE  
 BEEN EMP TO DATE ON SEMI STATIC TASKS ONLY  
 AND CANNOT BE CONSIDERED FULLY OPERATIONAL YET O  
 FURTHER CMM UNTIL ALL SIX FSVs ARE RECEIVED  
 GROUPEd FOR THEIR CAVALRY ROLE AND PROVEN  
 EFFECTIVE IN THAT ROLE CMM IT WOULD BE  
 OPERATIONALLY UNSOUND FOR CARRIERS TO  
 BE RETURNED TO AOD

PAGE <b>1</b> OF <b>1</b> PAGES	REFERS TO MESSAGE <b>YES</b>	DRAFTER'S NAME <b>WEIR</b>	OFFICE <b>Dland</b>	TEL. NO. <b>Elony 29</b>
FILE REFERENCE <b>579-1-57</b>	CLASSIFIED <input checked="" type="checkbox"/> YES <input type="checkbox"/> NO			

FOR OPERATOR'S USE								RELEASING OFFICER'S SIGNATURE	
R	DATE	TIME	SYSTEM OPERATOR	OPERATOR	DATE	TIME	SIGNATURE	OPERATOR	RANK
							<b>W. J. ...</b>		<b>Col</b>

ELT FORM 53

# MESSAGE FORM

87

FOR COMMUNICATIONS USE

REFERENCE ACTION <b>PRIORITY</b>	REFERENCE INFO <b>PRIORITY</b>	DATE-TIME GROUP <b>060600Z</b>	MESSAGE INSTRUCTIONS
FROM: <b>IATF</b>			REF ID: <b>CR</b>
TO: <b>161 RECCE FLT 104 SIGSON</b>			SECURITY CLASSIFICATION
INFO: <b>G2 AIR LO BARRIA LO HOA LONG G3ops</b>			<b>RESTRICTED</b>
			ORIGINATOR'S NUMBER
			<b>OPS 1180</b>

DAILY AIR DOCUMENTS RUN(.)

ONE (.) WITH EFFECT FROM 0600 HRS ON 8 JUL 71 COMM  
THE RW AIRCRAFT RUN IS TO INCLUDE HOA  
LONG (LONG LE DISTRICT) AS PART OF ITS  
DAILY ITINERARY(.)

TWO (.) 104 SIGSON TO LIAISE DIRECT WITH 161 RECCE  
FLT (.)

THREE (.) LO HOA LONG IS TO ENSURE THAT THE AIC  
IS MET DAILY BETWEEN 0600-0700 HRS(.)

PAGE <b>1</b> OF <b>1</b> PAGES	REFERS TO MESSAGE	DRAFTER'S NAME	ORIGIN	REL. NO.
FILE REFERENCE	CLASSIFIED <input checked="" type="checkbox"/> YES <input type="checkbox"/> NO	<b>ESMONDE</b>	<b>G3ops</b>	<b>E6 10</b>
FOR OPERATOR'S USE			RELEASING OFFICER'S SIGNATURE	
IR	DATE	TIME	SYSTEM	OPERATOR
				

REF FORM 52

MESSAGE FORM

88

FOR COMMUNICATIONS USE

PRECEDENCE ACTION

PRIORITY

PRECEDENCE INFO

PRIORITY

DATE/TIME GROUP

160700Z Jul 71

MESSAGE IDENTIFIERS

PREP

OR

FROM:

IATF

TO:

LIST A LESS SERIALS 35-36

INFO:

PLUS ALL IATF LO'S

SECURITY CLASSIFICATION

RESTRICTED

ORIGINATOR NUMBER

INFO

LIST C

DAILY DOCUMENTS RUN (1)

051226

ONE (1) WITH EFFECT 170600 THERE WILL BE NO

DOCUMENTS RUN BY RW A/C TO FSB MAUREEN

TWO (2) WITH EFFECT 170600 THERE WILL BE A

DOCUMENTS RUN TO FSB LYNETTE by RW A/C

THREE (3) OTHER DESTINATIONS FOR RW AND FW DOCS

RUN NO CHANGE

FILE REFERENCE

FILE REFERENCE

LINKS TO MESSAGE

CLASSIFIED

YES  NO

DRAFTER'S NAME

ESMONDE

GRADE

COps

TEL. NO.

E610

FOR OPERATOR'S USE

RELEASING OFFICER'S SIGNATURE

DATE

TIME

SYSTEM OPERATOR

DATE

TIME

SYSTEM

OPERATOR

R

D

NY FORM 52

MESSAGE

89

ROUTINE            ROUTINE

170800Z JUL 71

FROM    :    1 ATF

TO       :    LIST A LESS SERIALS 25-36  
          :    PLUS 1 ATF LOs: AND LIST C

RESTRICTED

OPS 1230

DAILY DOCUMENT RUN.

ONE     :    WITH EFFECT 190600 JUL THERE WILL BE NO DOCUMENT RUN BY RW A/C TO  
          :    FSB MARY .

TWO     :    WITH EFFECT 190600 JUL THERE WILL BE A DOCUMENTS RUN TO FSB DEBBIE  
          :    (YS4489) BY RW A/C .

THREE   :    WITH EFFECT 180600 JUL THE FW A/C DOC RUN WILL OPERATE SEVEN DAYS A  
          :    WEEK

PAGE ONE OF ONE PAGES

CLASSIFIED YES

ESMONDE GS03 (OPS) EBONY 10

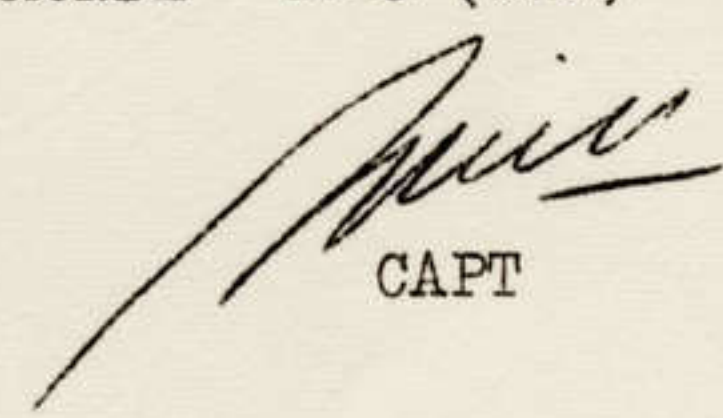
  
CAPT

MESSAGE FORM

*890*

PRIORITY - PRIORITY 210100Z JUL 71

FROM : 1 ATF

RESTRICTED

TO : LIST A (LESS SERIALS 25 - 36)  
LIST C AND ALL 1 ATF LO's

OPS 1248

DAILY DOCUMENTS RUN . -

ONE ! WITH EFFECT 210600H JUL 71 THERE WILL BE A DOCUMENTS RUN TO  
FSB CHERIE (YS4590) BY RW A/C !

TWO ! OTHER DESTINATIONS NO CHANGE

PAGE 1 OF 1 PAGES

CLASSIFIED YES

ESMONDE GS02 (OPS)

EBONY 10

*[Handwritten Signature]*  
CAPT

CONFIDENTIAL

AUSTRALIAN ARMY

91

PSYOPS723/1/1

Headquarters  
1st Australian Task Force  
NUI DAT

5 Jul 71

See Distribution Below

1 ATF MONTHLY PSYOPS REPORT  
JUNE 1971

General

1. 1 ATF PsyOps activities for Jun 71 are summarised at Annex A.

PsyOps Int

2. Enemy activity showed a drop in reported incidents from 58 plus 14 late reports in May 71 to 44 in Jun 71.
3. There has been no evidence of the programme to kidnap and propagandise PSDF members that was reported in May.
4. Most incidents have taken the form of approaches to villagers with a view to spreading propaganda, requesting information or demanding food or taxes.
5. There were three persons assassinated during June.
6. Propaganda distributed by the VC in June followed the usual pattern of explaining VC victories in LAOS and CAMBODIA and calling on the people to rise up against the 'puppet forces' and the 'agressors'.
7. A translation of the judgement and sentence of NGHUYEN VAN BONG, who was assassinated in XUYEN MOC on 13 Jun 71 is attached as Annex B.

Activity of 1 PsyOps Unit

8. Air. There were a total of nine voice missions and four leaflet missions flown. These were directed at the following targets:
  - a. illegal gardeners east of XUYEN MOC - voice and leaflet missions,
  - b. BAU HAM Guerillas - voice and leaflet missions,
  - c. VC/NVA in the area of the Courtenay Rubber following an ambush - voice and leaflet mission (exploitation of a detainee wounded in the ambush), and
  - d. illegal woodcutters north east of XUYEN MOC - voice mission.

/Vandalism

CONFIDENTIAL

CONFIDENTIAL

- 2 -

9. Vandalism on CA Projects. A campaign to decrease the incidence of theft and vandalism on CA Unit projects was commenced. VIS, RDC and the Polwar Coy all agreed to urge people not to destroy or steal materials on these sites. A poster to be distributed by VIS and the CA Unit was developed.

10. Copies of leaflets and translations of voice messages are attached as Annex C.

11. Ground Team Operations. The ground team was deployed in the following areas during June:

- a. BINH BA - DUC THANH District,
- b. LONG HAI - LONG DIEN District,
- c. PHUOC HOA - LONG LE District, and
- d. PHUOC THO - DAT DO District.

12. Copies of the hamlet surveys completed are attached as Annex D.

Hoi Chanh

13. There were no ralliers to Aust Forces.

14. A woman who was captured following a 2 RAR/NZ(ANZAC) contact in April was reclassified Hoi Chanh during June.

15. 2 NVA rallied to GVN forces in CAM MY, LONG KHANH Province on 24 Jun 71. Both were involved in the contact with Australian forces that led to the exploitation mentioned in para 8.c. of this report.

Equipment and Stores

16. The production rate of the PsyOps Unit may suffer as a result of delays in the delivery of essential supplies of printing plates and 'blankets' for the 1275 press.

17. Efforts by Ord to ensure quick delivery of these items have so far not been successful and care is being taken to use existing stocks on essential projects only.

18. A PAKOCORP glazing machine was indented for, delivered and installed during June. The prompt service is appreciated.

Interpreters and Bushman Scouts

19. 70 ARVN interpreters are being administered by 1 ATF. The number of Bushmen Scouts employed is 22.

Personnel

20. Capt C. HUNTER returned to Australia on 30 Jun and was replaced by Capt C.B. McAULEY RAASC.

*B.A. McDonald*  
(B.A. McDONALD)  
Brig  
Comd

CONFIDENTIAL



CONFIDENTIAL

- 3 -

- Annexes:
- A. Summary of PsyOps Activity.
  - B. VC Propaganda.
  - C. 1 ATF Propaganda.
  - D. Hamlet Surveys.

Distribution List:

HQ AFV (9)

For Information:

HQ TRAC (Attn S3)  
4 RAR/NZ(ANZAC)  
3 RAR  
161 (Indep) Recce Flt  
File  
Spare (5)

CONFIDENTIAL

SUMMARY OF PSYOPS ACTIVITY  
JUNE 1971

1. Air:
  - a. Voice Missions - 9, and
  - b. Leaflet Missions - 4.
2. Ground Activities:
  - a. Ground Team - 4 areas of ops each of 5 days duration.
  - b. Loudspeaker Missions - 12 hours.
  - c. Leaflets distributed - 4,000.
  - d. Posters distributed - 3,000.
  - e. Other publications - 680.
  - f. - 16 hours.
3. Propaganda Production:
  - a. For 1 ATF:

(1) leaflets	-	339,000
(2) Posters	-	3,000
Total	-	<u>342,000</u>
  - b. For GVN Organisations:

(1) Hand bills	-	2,450
Total	-	<u>2,450</u>
  - c. Miscellaneous:

(1) Booklets	-	11,442
(2) Briefs	-	14,125
Total	-	<u>25,567</u>
  - d. Total Production - 370,017

CONFIDENTIAL

CONFIDENTIAL

ANNEX B TO  
1 ATF PSYOPS 723/1/1  
DATED 5 JUL 71

TRANSLATION OF JUDGEMENT OF  
ASSASINATED GVN OFFICIAL

NGUYEN-VAN-BONG has been a henchman for the enemy since 1962. Until 1969 he has been the security assistant of NHON TRI hamlet chief - the subject has captured, beaten and terrorized people. Especially, he has forced many young people to join PSDF and other GVN organizations. BONG has been educated by the People many times. He has received 3 warning letters from People's Liberation. But he did not repent.

1. BONG was judged by many of his atrocities.
2. The subject had been warned many times.
3. The subject was judged by the wills of the people.

Decision: BONG was sentenced death.

In order to save people from hardship and in order to give pattern to the others.

All armed forces, militia forces will execute this judgement.

13 Jun 71

People's Liberation Committee  
XUYEN MOC Village

CONFIDENTIAL

CONFIDENTIAL

ANNEX C TO  
1 ATF PSYOPS 723/1/1  
DATED 5 JUL 71

PROPAGANDA MATERIAL  
JUNE 1971

1. Attached are copies of leaflets together with translations and scripts for voice missions carried out in June 1971.

CONFIDENTIAL

TRANSLATIONS OF THE VOICE MISSIONS WHICH WERE FLOWN

Serial 1  
Target BAU HAM GUERRILLAS  
Time 30 seconds  
Message Attention VC Guerilla Units in this area. Why do you continue to stay in the jungles, away from your loved ones, starved and suffering hardships for a cause which has given you no victories?

Each day you suffer from the likelihood of being killed by GVN forces - for no purpose.

Return to your home and loved ones and live a life of peace and prosperity.

---

Serial 2  
Target Illegal Farmers of XUYEN MOC  
Time 20 seconds  
Message You are wrong to aid the enemies of the people of Vietnam. Your actions give the Armed Forces no choice but to destroy your crops and hunt you down. Return to your village and your families before this happens. You will be able to live a happy and prosperous life.

---

Serial 3  
Target VC Units in SR4 Region  
Time 30 seconds  
Message (Personal Appeal) Comrades of Convalescence Group SR4. I am TRUONG RINH HANH, soldier of the Convalescence group. Three days ago, I went out with this group and was ambushed by GVN allied troops. I was wounded and lay in the jungle for three days and nights without medicine or food. The unit did not come to save me either. The Australians found me and took me to the hospital. At present, I have been treated at the Australian hospital in VUNG TAU. I have been treated well. I call upon you comrades who are still in the VC ranks, even if you are wounded or not, especially Sister HOA, try to contact the Australian troops in this area and ask for Chieu Hoi. I believe you will be warmly welcomed. I hope to see you again.

Note: The leaflet had a similar message printed. The subject could not write due to wounds, but was able to give his signature.

/Serial 4

CONFIDENTIAL

ANNEX C

C - 3

Serial 4  
Target Woodcutters and Civilians outside "civilian access area"  
Time 10 seconds  
Message This is not a civilian access area! You must leave this area immediately! If you stay here, you put your own lives in danger. Help the GVN and allies to rid this area of the enemy. Leave Now!

CONFIDENTIAL

# TỰ - TỨC PHÁT - TRIỂN XÃ

Các lực-lượng Đồng-Minh trong Tỉnh Phước-Tuy đang giúp Chính-Phủ Việt-Nam Cộng-Hòa xây-  
dựng một thôn làng tốt đẹp hơn để đồng-bào sinh sống.

Những kế-hoạch này được thực-hiện để đồng-bào có thể sống một cuộc sống tốt đẹp hơn

MỘT SỐ TRONG NHỮNG CÔNG-TÁC CỦA CÁC KẾ-HOẠCH NÀY GỒM CÓ :

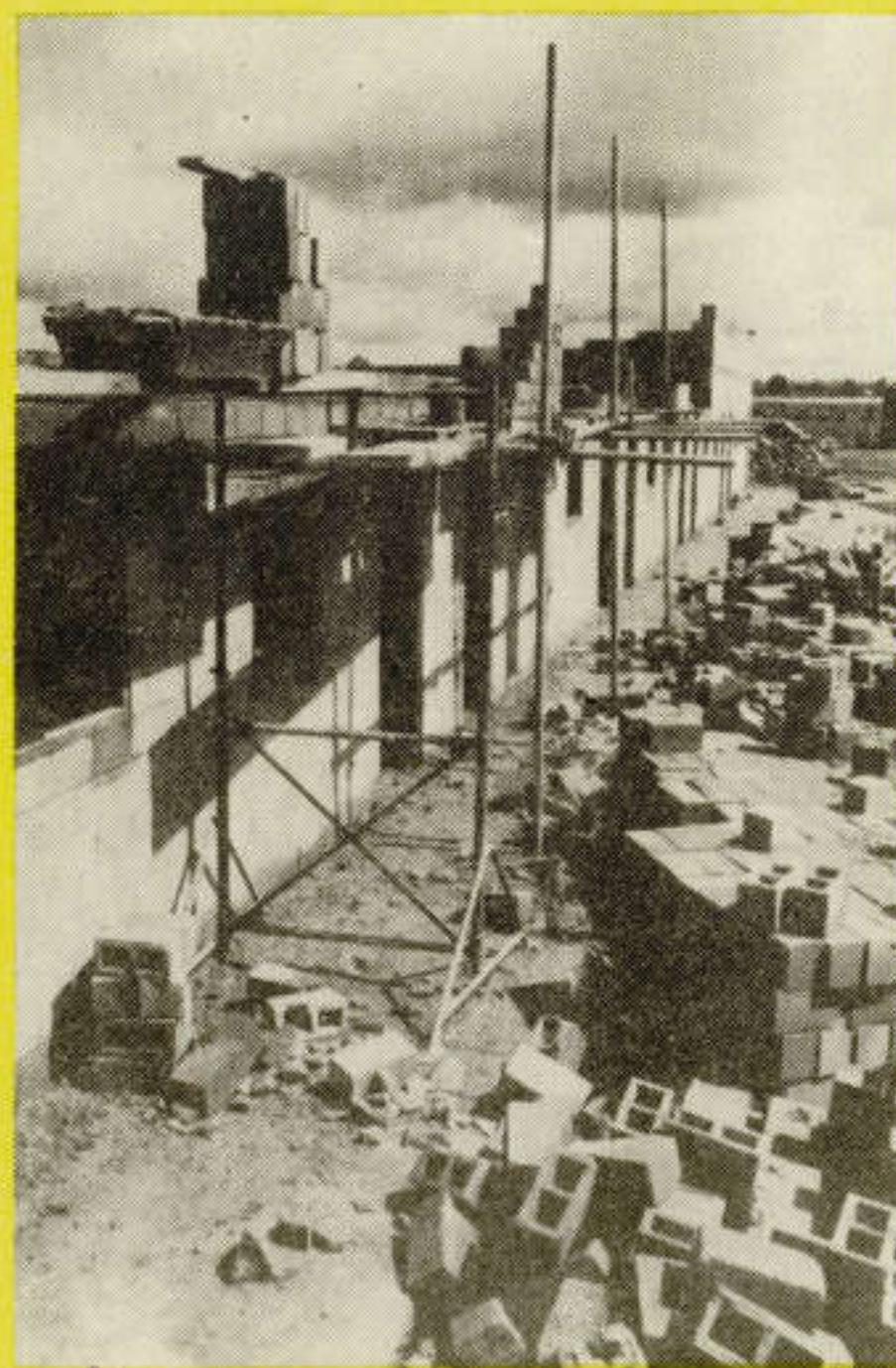

VIỆC XÂY CÁT NHÀ  
CỬA CHO BINH-SĨ. . .



ĐẮT GIẾNG NƯỚC CÓ QUẠT XỬ-DỤNG  
BẰNG SỨC GIÓ VÀ CÁC ỐNG BƠM NƯỚC  
ĐỂ DÂN TRONG LÀNG CÓ THỂ LẤY  
NƯỚC ĐỂ DÙNG. . .

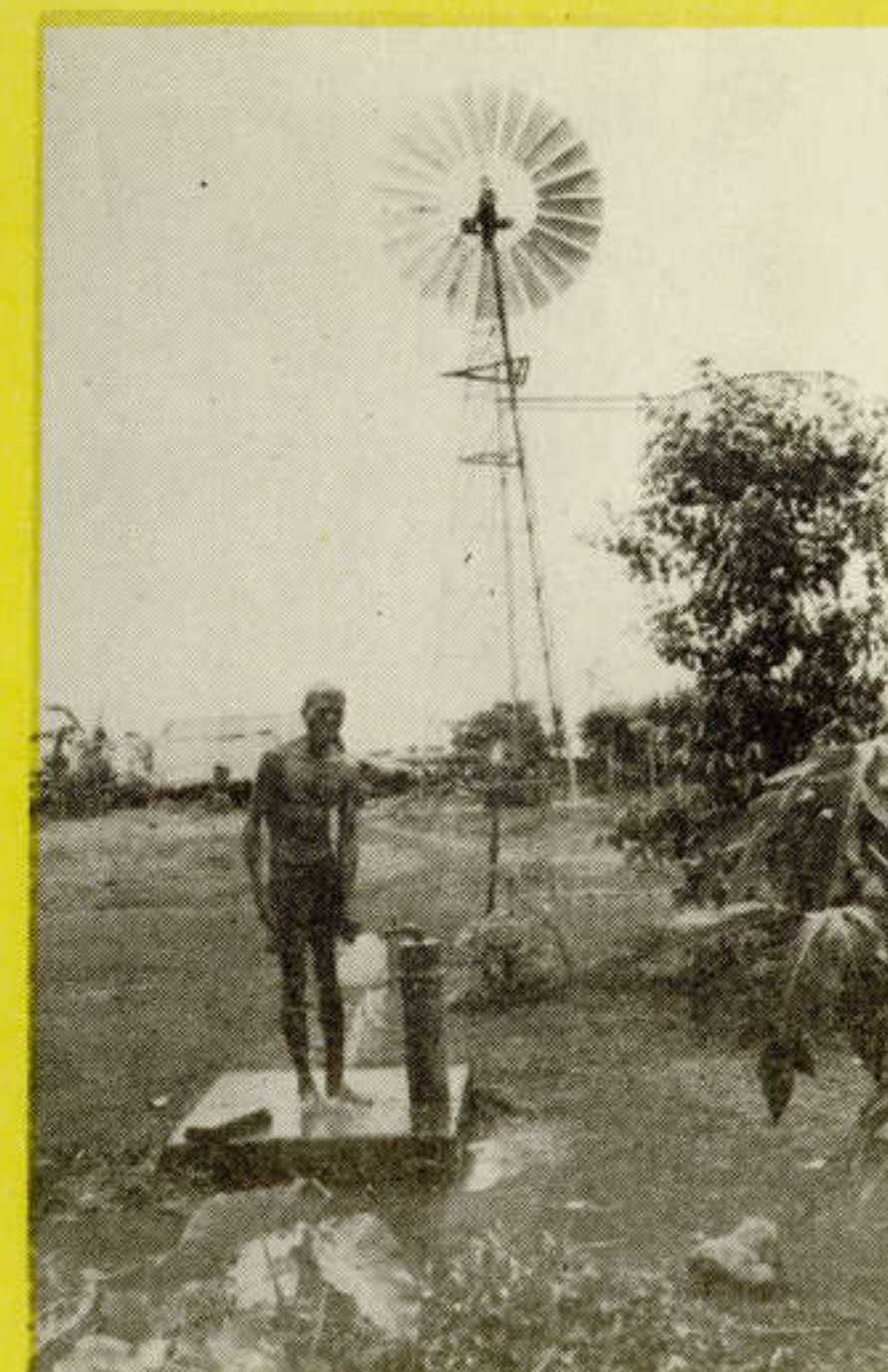

Phá hư các dụng - cụ hoặc đồ trang - bị của những kế - hoạch này là từ chối sự giúp đỡ  
của những người bạn của đồng - bào. Hãy giúp đỡ và yểm - trợ chương - trình phát - triển  
của Chính - Phủ Việt - Nam Cộng - Hòa cũng như duy - trì và bảo - vệ những kế - hoạch này.

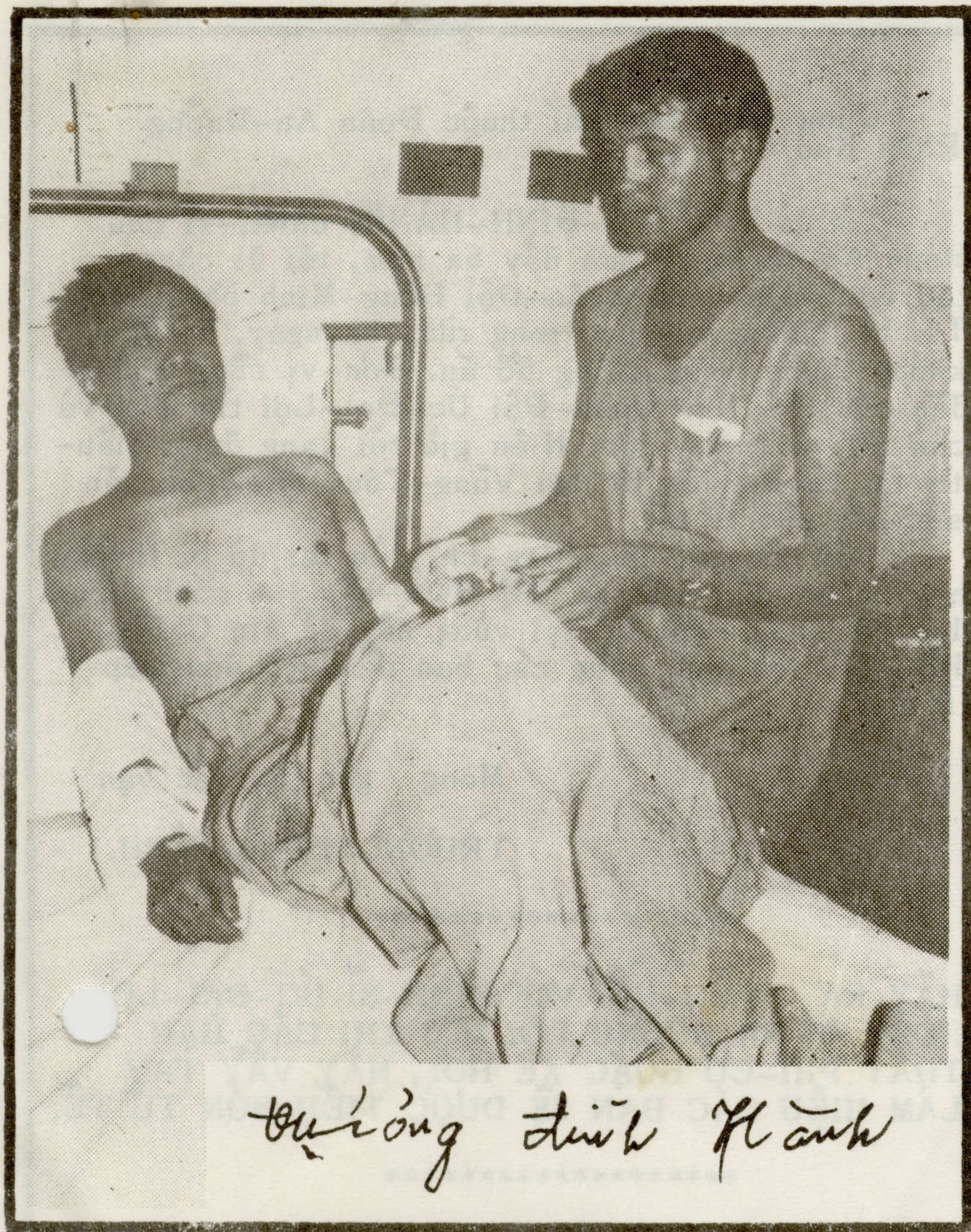

Bu'ông đình Khắc



Cùng các đồng-chí thuộc Đoàn An-Dương  
Phân Khu 4.

Tôi là TRƯỜNG-ĐÌNH-HÀNH, chiến-sĩ của  
Đoàn An-Dương. Cách đây ba hôm, tôi đi công-  
tác với Đoàn và bị Quân-Đội Đồng-Minh phục-kích.  
Tôi bị thương và nằm trong rừng ba ngày, ba đêm;  
không thuốc men, không đồ ăn. Đồn-vị cũng không  
đến cứu tôi. Nhờ Quân-Đội Úc-Đại-Lợi tìm gặp và  
chở tôi về bệnh-viện. Hiện giờ tôi đang được điều-  
tri tại bệnh-viện Úc tại Vũng-Tàu. Tôi được săn  
sóc hết sức tử tế.

Tôi kêu gọi các đồng-chí còn lại dù bị thương  
hay không-đặc biệt, là CHỊ HOÀ-hãy tìm cách liên-  
lac với Quân-Đội Úc tại vùng này để xin Chiêu-  
Hồi. Tôi tin chắc rằng các bạn sẽ được đón tiếp  
tử tế.

Mong gặp lại các bạn

TRƯỜNG-ĐÌNH-HÀNH.

\*\*\*\*\*

HÃY RA CHIÊU-HỒI VỚI BINH-SĨ ÚC-ĐẠI-LỢI  
HOẶC ĐI RA ĐƯƠNG LỘ. MỖI KHI CÁC BẠN  
THẤY PHI-CỘ HOẶC XE HỒI, HÃY VÃY TAY  
LÀM HIỆU CÁC BẠN SẼ ĐƯỢC TIẾP ĐÓN TỬ TẾ.

\*\*\*\*\*

## AUSTRALIAN MILITARY FORCES

*1 Psychological Operations Unit,  
AFPO4, GPO Sydney. 2890.*

DATE PRODUCED:

LEAFLET NO. POSTER  
TITLE DON'T DESTROY EQUIPMENT.  
THEME VILLAGE SELF DEVELOPMENT.  
SIZE 15¼ X 19½.  
COLOUR YELLOW, GREEN, RED, BLACK.  
TARGET AUDIENCE CIVILIANS.  
LANGUAGE VIETNAMESE.  
ORIGIN 1 PSY OPS.  
PURPOSE/OBJECTIVE TO INFORM THE CIVIL POPULATION TO MAINTAIN  
AND PROTECT THESE PROJECTS.

METHOD OF DISSEMINATION

BY HAND.

ENGLISH TRANSLATION

VILLAGE SELF DEVELOPMENT.  
ALLIED FORCES IN PHUOC TUY PROVINCE ARE HELPING THE GVN  
TO BUILD A BETTER PLACE FOR YOU TO LIVE IN.

SOME OF THESE PROJECTS INCLUDE.

THE BUILDINGS OF  
HOUSES FOR YOUR SOLDIERS

WINDMILLS AND PUMPS SO THAT THE  
VILLAGERS CAN GET WATER EASILY.

TO DESTROY PARTS AND EQUIPMENT FROM THESE PROJECTS IS TO DENY  
ASSISTANCE TO YOUR FRIENDS. HELP SUPPORT THE G.V.N. DEVELOPMENT  
PROGRAMME, AND MAINTAIN AND PROTECT THESE PROJECTS,

CONFIDENTIAL

ANNEX D TO  
1 ATF PSYOPS 723/1/1  
DATED 5 JULY 71

HAMLET SURVEYS - JUNE 1971  
AFTER ACTION REPORTS

1. The following After Action Reports are attached:
  - a. BINH BA - Appendix 1
  - b. LONG HAI - Appendix 2
  - c. PHUOC HOA - Appendix 3
  - d. PHUOC THO - Appendix 4

CONFIDENTIAL

CONFIDENTIAL

APPENDIX 1  
TO ANNEX D

BINH BA - DUC THANH DISTRICT

1. The background of BINH BA is similar to other villages in the DUC THANH District, in that all were subject to concentrated VC attacks in the 1960s, causing people to move to more secure areas.
2. The issue raised by the local villagers concerning the location of windmills is a valid one. Perhaps some investigations could be made as to the suitability of installing one windmill in the village.
3. The French influence in BINH BA itself has given the people some form of security, in that they are primarily paid and looked after by the residing French manager for the local rubber plantation (owned by Michelin). In general, because of this security, the people are disinterested in GVN sponsored projects.
4. Because of the spread of the four hamlets of BINH BA, and the associated breakup in work force, there is little to support a village community spirit.
5. Any PsyOp approach to BINH BA would have to be carried out at hamlet level to be fully meaningful.

CONFIDENTIAL

CONFIDENTIAL

APPENDIX 2  
TO ANNEX D

LONG HAI - LONG DIEN DISTRICT

1. LONG HAI village consists of startling contrasts. The village has a large number of known VC, VCI and VCS families, yet the infiltration rate etc from local guerilla units is minimal. The village location at the foot of the LONG HAI Mountains renders it susceptible to attack from a traditional guerilla stronghold, but shortly, the village is to become a well advertised tourist resort. The fact that it is also a vast training centre for ARVN, PF, PSDF and Cambodians (Mike Strike Force), again makes this area distinctive.
2. The potential of LONG HAI being created into a tourist centre is high. Already there are several hotels, although these contrast drastically with the substandard housing to the north of the village, and the poor roads between the hamlets.
3. Obviously, factors such as the ready supply of fresh water etc will have to be overcome, prior to any planned advertising getting under way.
4. The reconstruction of the local villas which were built in DIEM's time indicates that some of the more wealthy people believe that LONG HAI (V) has sufficient security on which to gamble such expense on extensive renovating.
5. As a potential area for PsyOps, it remains relatively closed; since the village is to become a GVN sponsored tourist centre, the employment of psyops would be more likely to have the opposite effect on people due to the atmosphere of the area.
6. Because LONG HAI, is in fact considered suitable as a resort area - despite the location to VC held territory, this in itself maybe a sign of growing GVN strength and solidarity.

CONFIDENTIAL

CONFIDENTIAL

APPENDIX 3  
TO ANNEX D

PHUOC HOA - LONG LE DISTRICT

1. This village consists of ten hamlets which are spread for 12 Km along route 15. The recognition of hamlets forming a village is almost non-existent. The physical distance has caused the "insular" characteristic, so well known in SVN, to become even more apparent in PHUOC HOA.
2. It was noted that the village chief and several other officials were to be removed from office due to their misappropriation of funds. The amount of time it has taken to apprehend these people, reflects on the lack of general communication, from one hamlet to the next as to the efficiency of the administration.
3. Although there is some consistency between hamlets with respect to Religion and Employment, it is considered that any PsyOps approach would have to be made at hamlet level to be of any real value.
4. Village Self Development has been broken down for the sake of simplicity to the hamlet level. It is pleasing to note the emphasis placed on "industry" building within the hamlets as opposed to spending the money on Temples and Dinh.
5. The people are in some respects unfortunate in that the nearby area ( Rung Sat Secret Zone) is VC dominated. This results in heavy taxation, terrorism and other forms of abuse, which the people must suffer, in order to carry out their daily lives.
6. A logical approach to the problem, is to try and unite the people in the hamlets, so that they become "village conscious" and thus, a less pregnable target for VC activity.

CONFIDENTIAL

CONFIDENTIAL

APPENDIX 4  
TO ANNEX D

PHUOC THO - DAT DO DISTRICT

1. PHUOC THO is a typical rural village with very few outstanding features to make it different from neighbouring villages and those in other districts.
2. Although a somewhat poor village, it is pleasing to see the village council and administration committee working to the best of their ability.
3. The idea of producing a village newspaper (the first attempt ever), to make the people aware of their situation and to inform them of local events is an admirable one. It is not known how long the local supplies of paper and ink will hold out, but officials have been notified that the cover page can be produced for them (heading only) by PsyOps thus enabling some motivation for continuing the project.
4. The grenade incident (later proved to be an accident and not a VC attack) was regrettable. The death of the village chief and deputy for security was indeed unfortunate.
5. The relatively active VIS and RDC cadre would be the main Vietnamese bodies to work with for employment of future PsyOps in that area.

CONFIDENTIAL

AUSTRALIAN ARMY

91

Headquarters  
1st Australian Task Force  
NUI DAT

R569/1/2

19 Jul 71

1 PsyOps Unit

PSYOPS DIRECTIVE NO 110  
PSYCHOLOGICAL OPERATIONS AREA STUDY  
PHUOC TUY PROVINCE

General

1. The most critical element of a PsyOps campaign is to identify effective susceptible target groups and develop detailed intelligence about them.
2. The term 'detailed intelligence' must be viewed in the light of the role of the Psy Op, which is "to influence the emotions, opinions, attitudes and behaviour of the target audience". The matters that could affect these things are both material and emotional and therefore involve aspects additional to those normally included in the collection of battle intelligence for the purpose of furthering tactical operations.
3. The information gained is best filed in a way that will allow cross reference to enable quick 'picture' of the target audience to be built up, not only as a group in itself but as a group within the community.
4. This is best achieved by the compilation and continual updating and revision of a PsyOps area study.

Aim

5. The aim of this Directive is to promulgate the policy for the preparation of a Psychological Operations Area Study of PHUOC TUY Province.

Responsibility

6. 1 Psy Ops Unit is to prepare the area study under the guidance of the G Staff (CA/PsyOps) HQ 1 ATF.

Sources and Facilities

7. Much of the information required is already available in previous studies conducted by 1 PsyOps Unit.
8. Intelligence produced in regular SITREPS, INTSUMS and PERINTREPS should all be perused for useful PsyOps content.
9. Newspapers, periodicals etc should all be studied with a view to determining any useful content.
10. Local authorities should be interviewed with a view to answering specific questions or voicing opinions on matters on which they are qualified.

..../11. There



11. There is a big requirement for a skilled ground team to visit local areas as part of a planned programme to gather the intelligence required by interviews and observations.

12. The principle is that there is no intelligence that is not at least potentially useful to Psy Op. Every opportunity is to be made to collect, evaluate and if useful record information from all sources.

13. Requests for access to sources outside the Province e.g. National Library SAIGON, JUSPAO etc, should be referred to G Branch (CA/PsyOps) HQ 1 ATF.

#### Evaluation

14. The basic question to be answered is, is the information valuable in the current or likely future PsyOps campaign? If in doubt the information should be included.

15. Care is to be taken to ensure the reliability and accuracy of information. Corroboration should be sought whenever possible.

#### Areas of Interest

16. The study is to include the following areas of interest:

a. General Situation:

(1) General (a brief summary of the current situation in the Province).

(2) PsyOps (a detailed analysis of friendly and enemy PsyOps).

b. Background:

(1) Historical.

(2) Geographical.

(3) Structure and characteristics of the society and culture.

(4) Government and politics.

(5) The economy:

(a) General,

(b) agriculture, forestry, fisheries,

(c) industry,

(d) trade and finance, and

(e) labour.

(6) Health, welfare, recreation and education.

(7) Transport and communications.

.../(8) Information

- (8) Information and propaganda.
- (9) The armed forces
- (10) The attitude to and effect of past and current tactical ops.
- (11) The attitude to FWMAF in the Province.

c. Target Analysis. This is to include detailed information as to the susceptibility, effectiveness and attitude as well as the characteristics of the target groups identified. These may include:

- (1) Government officials and administrators,
- (2) religious groups,
- (3) ethnic groups,
- (4) military,
- (5) women,
- (6) urban dwellers, and
- (7) rural population.

This list is not exhaustive. Further groups may be identified as the study progresses. Specific functional groups may exist within categories.

d. Media Analysis. An evaluation of all media available in the Province including:

- (1) Radio and TV,
- (2) newspapers,
- (3) leaflets, posters bulletin boards,
- (4) motion pictures, and
- (5) other (e.g. RDC, APT, variety shows),

e. Psychological Opportunities and Vulnerabilities. This is an orderly listing of exploitable conditions. Much of the information will have been already recorded. It should be summarised in this form for ease of reference.

f. Annexes. Some suggested annexes are:

- (1) Significant dates,
- (2) Do's and Don'ts for personal contact,
- (3) proverbs, symbols, superstitions etc, and
- (4) order of precedence for local officials.

.../17. OC 1 PsyOps

17. OC 1 PsyOps Unit is to submit his plan for the preparation and revision of the area study to the GSO2 (CA/PsyOps) as soon as possible.

18. The plan is to include provision for regular reporting of progress and discussion with G (CA/PsyOps) staff.



(D.M.Y. SMITH)

Maj

For Comd

MESSAGE FORM

93

ROUTINE ROUTINE 27 06 30 Z (JUL 71) R499/2/8  
FROM : 1 ATF CONFIDENTIAL  
TO : LIST A (LESS SERIALS 25 - 36) OPS1274  
PLUS ALL 1 ATF LOS LIST C

DAILY DOCUMENTS RUN (!)

- ONE (.) WITH EFFECT FROM 290600H FSB KATE (YS4288) WILL BE INCLUDED ON THE RW AC DAILY DOCUMENTS RUN (!)
- TWO (.) ALL DELIVERIES FOR HQ 3 RAR ARE TO BE CLEARLY ADDRESSED TO FSB KATE WITH EFFECT 290600H JUL 71 (!)
- THREE (.) THE DAILY RUN TO FSB ZIGGIE WILL CONTINUE (!)
- FOUR (!) OTHER DESTINATIONS NO CHANGE

PAGE 1 OF 1 PAGES CLASSIFIED YES ESMONDE GS03 (OPS) EBONY 10

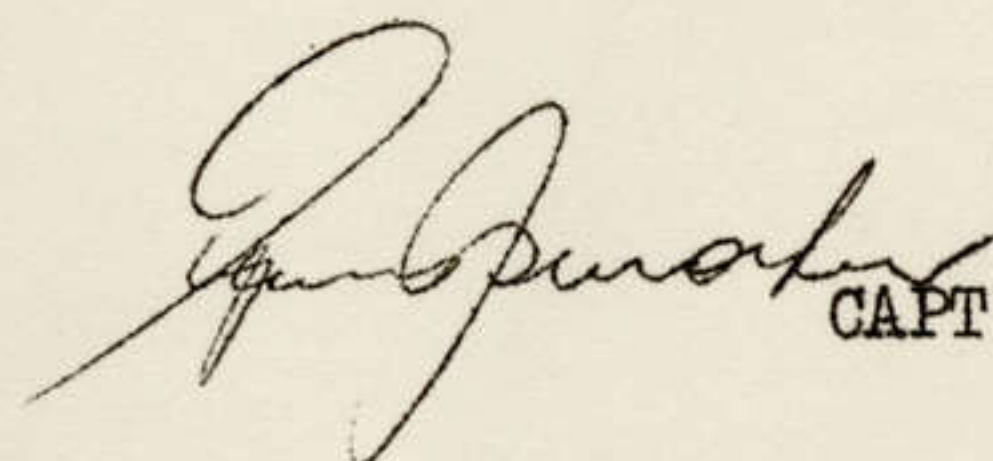
  
CAPT

94

MESSAGE FORM

PRIORITY

28 1100 Z JUL 71

FROM : 1 ATF

CONFIDENTIAL

TO : LIST A

GPS 1306

1 ATF LO'S

LIST C

DAILY DOCUMENTS RUN

FOR THE DURATION OF OPERATION IRON FOX THERE WILL BE A DAILY RW DOCUMENTS  
RUN TO C SQN 1 ARMD REGT FORWARD AT YS4094 COMMENCING 290600H JUL 71

PAGE ONE OF ONE PAGES

CLASSIFIED YES

ESMOND

GS03 (OPS) EBONY 10

*[Handwritten Signature]*  
CAPT

95

MESSAGE FORM

PRIORITY

02 2400Z JUL 71

R723/1/51

CONFIDENTIAL

OPS1161

FROM : 1 ATF  
TO : AUSTFORCE VIETNAM

REFERENCE HQ TRAC LTR-DCS CMM SUBJECT MONTHLY STATISTICS REPORT CMM DATED  
19 JAN 69 . FOLLOWING INFO SUBMITTED FOR PERIOD 01 JUN 71 TO 30 JUN 71 .

- ONE : FRIENDLY KIA CMM 8 CMM DOW 1.
- TWO : FRIENDLY WIA CMM 39 .
- THREE : CONTACTS CMM 41 .
- FOUR : EN KIA CMM 28 .
- FIVE : PW CAPTURED CMM 4 .
- SIX : TOTAL VCI KILLED AND CAPTURED CMM NIL .
- SEVEN : HOI CHANH CMM NIL .
- EIGHT : TOTAL SA CAPTURED AND DESTROYED CMM 11 .
- NINE : TOTAL CREW SERVED WPNS CAPTURED AND DESTROYED CMM NIL

PAGE ONE OF ONE PAGES CLASSIFIED YES CONNOLLY G CLERK EBONY 25

*[Handwritten Signature]* CAPT

96

MESSAGE FORM

030/00Z JUL 71

Z183/1/1

CONFIDENTIAL

OPS 1162

PRIORITY

PRIORITY

FROM HQ 4 ATF

TO HQ TRAC

FOR ATTENTION NACTR - GJAD . SUBJECT COMBAT STATISTICS .

ALFA . 11 .

BRAVO . 23 .

CHARLIE . 28 .

DELTA . 4 .

ECHO . NIL .

FOXTROT . 39 .

GOLF . 2 .

HOTEL . 5 .

PAGE 1 OF 1 PAGES CLASSIFIED YES HILL DUTY OFFICER

*[Handwritten Signature]*  
CAPT

91

MESSAGE FORM

PSYOPS

FOR OFFICIAL USE ONLY

PRECEDENCE CLASS	PRIORITY INFO	DATE/TIME GROUP	MESSAGE INSTRUCTIONS
ROUTINE		130900Z	
FROM: 1 ATF			CLASS
TO: AUSTRALIAN FORCE VIETNAM			GR
INFO:			SECURITY CLASSIFICATION
			UNCLAS.
			OPERATOR'S NUMBER
			OPS 1213

BUSHMAN SCOUTS @ REPORT FOR MONTH OF JUN 71 @  
 ONE PD EMPLOYING UNITS CMM 3RAR CMM 1ARU CM 1PSYOPS @  
 TWO PD NUMBER ALLOCATED CMM FORTY PD  
 THREE PD NUMBER EMPLOYED CMM TWENTY TWO PD  
 FOUR PD NUMBER KIA CMM NIL  
 FIVE PD NUMBER WIA CMM NIL  
 SIX PD NUMBER MIA CMM NIL  
 SEVEN PD NUMBER DESERTED CMM NIL  
 EIGHT PD NUMBER AWOL CMM NIL  
 NINE PD NUMBER DISCHARGED DURING MONTH CMM NIL PD  
 REGRET LATE RETURN

TIME	DATE	TIME	DATE	RECEIVED	CLASSIFIED	OPERATOR'S NAME	OFFICE	PL. NO.
1309	1 JUN	1309	1 JUN		No	McAULEY	PSYOPS	70
FOR OPERATOR'S USE						RELEASING OFFICER'S SIGNATURE		
RE	REQ	TIME	SYSTEM	OPERATOR	DATE	Bill McAuley Capt.		

LET FORM 82



RESTRICTED

AUSTRALIAN ARMY

Headquarters  
1st Australian Task Force  
NUI DAT

R572/1/18

20 Jul 71

SOP Distribution List

AMENDMENT NO 9 TO 1 ATF SOPs

Reference: A. 1 ATF SOP's dated 10 Feb 71.

1. 1 ATF SOP's are amended as follows:
  - a. delete existing pages 1-15, 1-16, 1-17, A1-1, I1-1, Appendix 6 to Annex D to Chapter I;
  - b. insert new pages 1-15, 1-16, 1-17, A1-1;
  - c. insert new Annex I, and Appendix 6 to Annex D of Chapter one; and
  - d. delete the following paragraphs of Chapter 6 Sect 1 604-610.
  
2. An amendment to Chapter 6 Sect 1 of 1 ATF SOP's may be anticipated in the near future.

(B.W. McFARLANE)  
Maj  
For Comd

RESTRICTED

RESTRICTED

1-15

- b. net and stations experiencing jamming or deception, including locations;
- c. frequency;
- d. action taken by friendly stations; and
- e. narrative of incident including effectiveness.

180. Units are to devise counter measures to suit their particular equipment and nets. Note the following:

- a. If imitative deception is suspected have the station authenticate.
- b. If jamming is experienced;
  - (1) try to avoid indicating the effectiveness of the jamming; and
  - (2) have a standard procedure where by stations change automatically to an alternative frequency.

Radio Interference

181. The crowded VHF channels result in considerable interference. With FM radios it is often possible for the desired signal to override the interfering one. Should this not be possible change to an alternative frequency and report the following to the Task Force Signal Officer:

- a. date, time and duration of interference;
- b. net and stations experiencing interference, including locations;
- c. frequency;
- d. identification of interfering stations; and
- e. effectiveness of interference.

Time

182. Time within 1 ATF is maintained by the 1 ATF Signal Centre. Time checks may be obtained by telephoning the signals centre or from the control station of the Task Force Command Net.

183. Local (H) time is used for all matters except the date/time group of messages where Z time followed by month and year is used.

SECTION 5 - LIAISON

General

104. When two or more elements are operating so that the activity .../of one

AMENDMENT NO 9  
DATED 20 JUL 71

RESTRICTED

RESTRICTED

1-16

of one would affect the other, such activities are to be co-ordinated by the next senior HQ in the area. For example, the movement of two companies from neighbouring battalions working close to a common boundary would be co-ordinated by HQ 1 ATF.

185. Commanders are to exercise initiative in establishing liaison with local forces and civil authorities within assigned areas of operations.

186. If no other direction is given units are responsible for liaison with 1 ATF units on their flanks. Liaison outside 1 ATF TAOR and AO will be effected by HQ 1 ATF.

Deployment of 1 ATF LOs

187. 1 ATF LOs are deployed to:

- a. PHUOC TUY Sector;
- b. some sub-sector HQs in PHUOC TUY Province;
- c. flanking TAOR formations; and
- d. GVN/FWMAF units, under operation control, when co-ordinated operations are undertaken.

188. Units may require liaison when deployed on limited independent operations in an AO, in close proximity to RVNAF, RF/PF or FWMAF locations or AOs. These liaison personnel are to operate on their parent unit command net using unit signallers. These liaison personnel will be administratively self contained.

189. In PHUOC TUY Province 1 ATF LOs are permanently located at Sector and some Sub-Sector HQs. When additional liaison is required as in para 187; above, radio operators with equipment are to be provided by the liaising unit. All liaison with the District Chief and District Senior Advisor will be channelled through the 1 ATF LO.

190. LOs are not to be deployed without the concurrence of the GS02 (Ops), through whom arrangements with formations, sector or units involved are made.

Detachments for 1 ATF Duties

191. The roles, tasks, responsibilities and organisation of detachments from 1 ATF, for specific duties, are listed at Annex I to this Chapter.

192. The following detachments are listed at Annex I:

- a. 1 ATF Liaison Unit;
- b. Det AFV Pro Unit, NUI DAT, (WEST GATE);

.../c. Det AFV.

AMENDMENT NO 9  
DATED 20 JUL 71

RESTRICTED

RESTRICTED

1-17

- c. Det AFV Pro Unit, VUNG TAU (Town Patrol); and
- d. Pearson Centre.

Provision of 1 ATF LO Teams

193. The basic Sub-Sector LO Team will comprise:

- a. Capt/Lt/WO - one
- b. Op Radio - one
- c. Int representative - one

194. GS (Ops) will determine which units are responsible for the provision of personnel. A Branch will provide the personnel and control relief or replacement on advice from the GS02 (Ops).

195. Unit/Sub-Sector affiliations will usually form the basis for the provision of permanent 1 ATF LOs.

196. LO Teams to flanking units will usually consist of one Lt/Capt and three Op Radio.

197. Visits to LO locations are to be made frequently by Ops, Int and CA staff, to effect further briefing and debriefing.

198-200. Reserved.

AMENDMENT NO 9  
DATED 20 JUL 71

RESTRICTED

RESTRICTED

ANNEX A TO  
CHAPTER 1

OUTLINE ORGANISATION

1 ATF CP

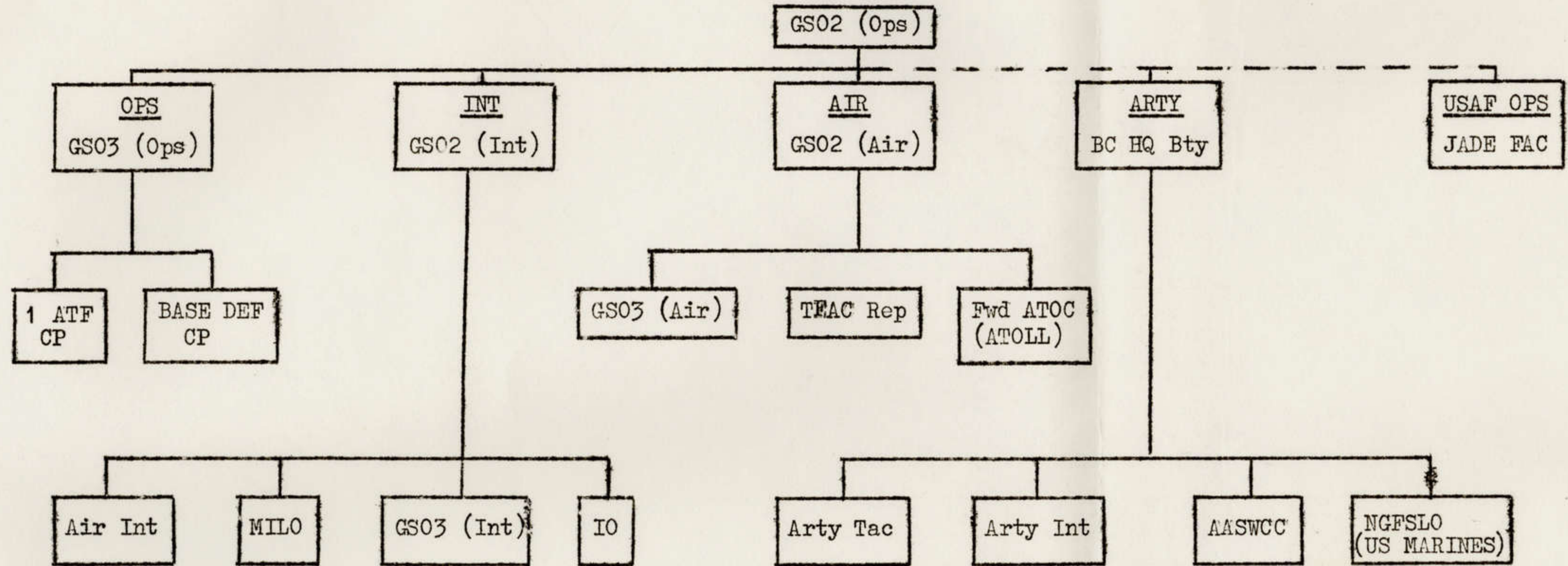

RESTRICTED

AMENDMENT NO 9  
DATED 20 JUL 71

DETACHMENTS FOR 1 ATF DUTIES

1 ATF Liaison Unit - General

1. Role. The role of 1 ATF Liaison Unit is to provide liaison between HQ 1 ATF, flanking formations, PHUOC TUY Sector and Sub-Sector HQa and MACCORDS Advisory Team 89.
2. Organisation. 1 ATF Liaison Unit is a working group of personnel, detached to HQ Coy 1 ATF from various units for 1 ATF liaison duties. The outline organization is shown below:

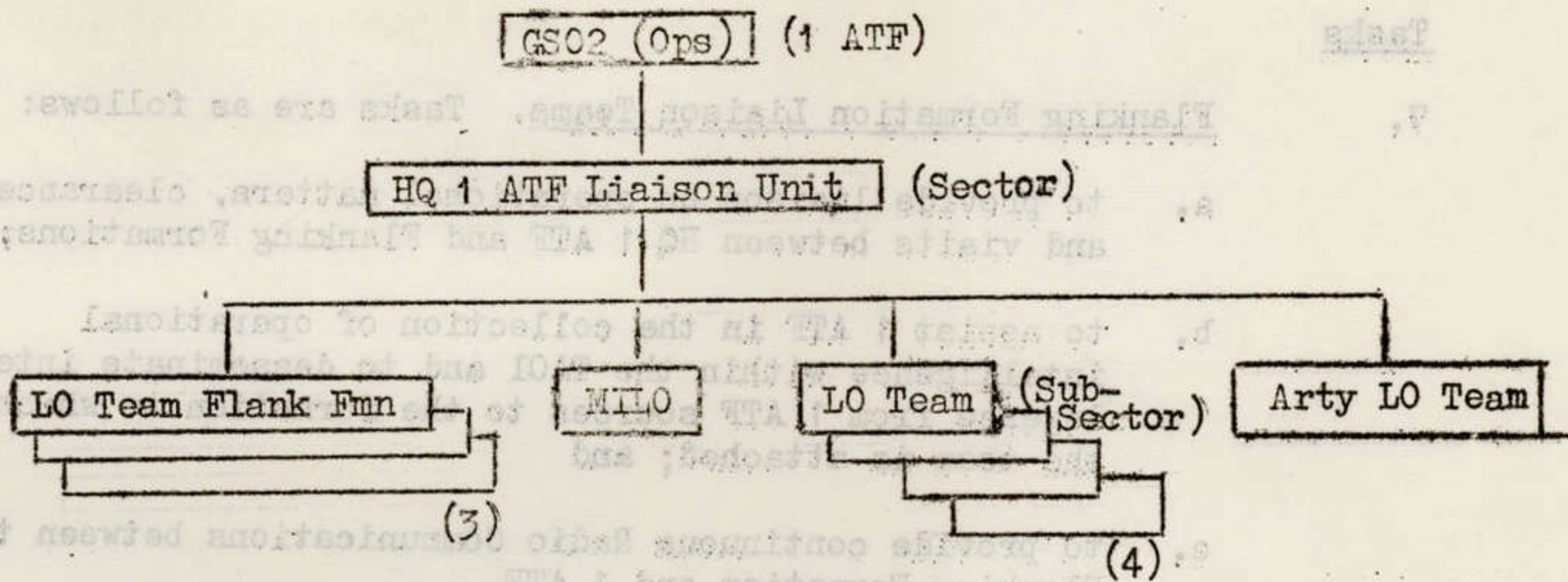

3. The detailed internal organization of 1 ATF Liaison Unit is attached as APPENDIX 1.

Command and Control

4. Arrangements for command and control are to be as follows:
  - a. HQ 1 ATF commands all teams of the 1 ATF Liaison Unit, OC HQ Coy 1 ATF is to be the CO of all ranks for disciplinary purposes,
  - b. The OC 1 ATF Liaison Unit (LOBARIA) is to exercise operational control and restricted administrative control over all ranks of the unit. Flanking Formation LOs and Sub-Sector LOs are to command the members of their teams.
  - c. Technical direction is to be exercised in the following ways:
    - (1) MILO and Intelligence Operators by GS02 (Int);
    - (2) Arty Team by CO 12 Fd Regt; and
    - (3) for communications by OC 104 Sig Sqn.

.../5. In an

AMENDMENT NO 9  
DATED 20 JUL 71

5. In an operational emergency all teams are to come under the operational control of the senior officer commanding operations in each respective area as follows:

- a. Flanking Formation Teams by Commander of Formation to whom attached;
- b. Sector Team - Arty Team and MILO by LO BARIA; and
- c. Sub-Sector Teams by District Senior Advisor.

#### Liaison Responsibilities

6. Responsibilities of 1 ATF LOs are listed at Appendix 2.

#### Tasks

7. Flanking Formation Liaison Teams. Tasks are as follows:

- a. to provide liaison on operational matters, clearances and visits between HQ 1 ATF and Flanking Formations;
- b. to assist 1 ATF in the collection of operational intelligence within the TAOL and to disseminate intelligence from 1 ATF sources to the formation to which the team is attached; and
- c. to provide continuous Radio Communications between the Flanking Formation and 1 ATF.

8. Sector Liaison Team. Tasks are as follows:

- a. to provide liaison on any matters directed by GS02 (Ops) HQ 1 ATF between 1 ATF, PHUOC TUY Sector, MACCORDS Advisory Team 89 and other organisations as detailed;
- b. to provide Radio communication between Sector HQ and HQ 1 ATF; and
- c. to provide the framework to carry out its administrative responsibilities as laid down in para 11 below.

9. Sector Artillery Liaison Team. Its task is to maintain a presence in the PHUOC TUY FSOC, and ensure that "Arty Tac" at NUI DAT is informed of any matter of interest to them.

10. Sub-Sector Liaison Teams. Tasks are as follows:

- a. to provide Liaison between HQ 1 ATF, Sub Sector, DSA organisation and 1 ATF battalions on operational matters or on matters as directed by GS02 (Ops) HQ 1 ATF;
- b. to assist HQ 1 ATF in the collection of operational intelligence; and
- ..../c. to provide

AMENDMENT NO 9  
DATED 20 JUL 71

I1-3

- c. to provide radio communications between Sub-Sector HQ and HQ 1 ATF.

### Co-ordination

11. Liaison teams are the direct representatives of Comd 1 ATF at HQs of flanking formations, US Advisory Teams, Sector and Sub-Sector Headquarters.

12. For local administrative and domestic matters, members of all teams are to conform to the routine practices of CORDS Advisory Teams.

### Briefings

13. Initial and weekly briefings are to be held as follows:

- a. On appointment all LOs are to report to HQ 1 ATF before assuming duty, for briefing by GS02 (Ops) and GS02 (Int). The co-ordination of such briefings is to be arranged through the GS03 (Ops).
- b. All LOs are to attend the weekly briefing held at HQ 1 ATF at 1330 hrs each Saturday. They are to submit a verbal and written report in the form shown at Appendix 3.

### Administration

14. A Branch HQ 1 ATF is to control attachments and detachments to and from 1 ATF Liaison Unit. Current unit responsibilities to provide and administer detachments are shown at Appendix 1.

15. The Authority for movement is a 1 ATF Detachment Instruction, showing the period of the detachment and is the authority for payment of "Living Out of Saigon" Allowance.

16. HQ 1 ATF Liaison Unit is responsible for:

- a. arranging Quartering;
- b. arranging payment of "Living Out of Saigon" Allowance, (with the exception of Flanking Formation Teams;)
- c. NOTICAS duties (Sub-Sector LOs report to 1 ATF direct);
- d. standdown;
- e. disciplinary control: (Disposal of charges is the responsibility of OC HQ Coy);
- f. welfare: (in conjunction with parent unit);
- g. reporting of accidents; and

.../h. for ensuring

AMENDMENT NO 9  
DATED 20 JUL 71



I1-4

- h. for ensuring that vehicle daily servicing is carried out and for ensuring that all vehicles are taken to HQ Coy transport compound weekly, for inspection and period servicing.

17. Parent units are responsible for:

- a. RTA procedures;
- b. R and R and R and C procedures;
- c. pay;
- d. routine medical matters (e.g. injections);
- e. routine documentation; and
- f. other unit admin (Through Liaison Unit Admin NCO).

18. Changeover of detached personnel is to be effected as follows:

- a. Personnel may be changed over at the request of parent units, or the LO BARIA, with the concurrence of HQ 1 ATF. As a guide, the minimum acceptable period of attachments is three months for LOs and Admin NCO, and one month for all others.
- b. Requests for changeover are to be submitted to the GSO2 (Ops) in the form shown at Appendix 4, and are to be submitted at least one week before the desired changeover date. G Branch will coordinate with A Branch on the issue of a detachment instruction.

19. Q matters are to be conducted in accordance with HQ Coy 1 ATF Q Directives.

#### Other Detachments

20. The following detachments are on a permanent basis:

- a. Det AFV Pro Unit, NUI DAT. Garrison Military Police (West Gate) - (4)
- b. Det AFV Pro Unit, VUNG TAU. Town patrol and detention barracks - (10).
- c. Pearson Centre. - (2).

21. A Branch HQ 1 ATF is to control, by means of detachment orders, detachments to and from AFV Pro Unit and Pearson Centre. The minimum period of detachment will be one month.

.../22. Requests

AMENDMENT NO 9  
DATED 20 JUL 71

RESTRICTED

ANNEX I

I1-5

22. Requests for changeover of personnel are to be submitted to the DAAG in the form shown at Appendix 3 and are to be submitted one week prior to the change over date.

Manning Details

23. Columns f and g of Appendix 1 are left blank in these SOP's. From time to time the GS02 (Ops) in conjunction with the DAAG will publish a replica of the Appendix with column f, filled in up to date and column g. showing other relevant details such as dates for change overs, R and R, RTA etc, together with any forecast changes in responsibilities for units.

AMENDMENT NO 9  
DATED 20 JUL 71

RESTRICTED

RESTRICTED

1I 1-1

APPENDIX 1  
TO ANNEX I  
TO CHAPTER 1

DETACHMENTS FOR 1 ATF DUTIES  
(Reference 1 ATF SOPs Chap 1 Sect 5)

Serial	Location	Appointment	Rank	Unit to Provide	Name	Remarks
(a)	(b)	(c)	(d)	(e)	(f)	(g)
1	Sector HQ	OC	Maj	HQ AFV		
2	Sector HQ	MILO	Capt	Det 1 Div Int		
3	Sector HQ	Arty LO	Lt	12 Fd Regt		
4	Sector HQ	RD NCO	WO/Sgt	1 ARU		
5	Sector HQ	Admin Sgt	Sgt	12 Fd Regt		
6	Sector HQ	Op radio (4)	Bdr/Gnr	12 Fd Regt		
7	Sector HQ	Dvr (2)	Pte	HQ Coy		
8	Sector HQ	Storeman	Pte	HQ Coy		
9	XUYEN MOC	LO	Capt/Lt	A sqn 3 Cav Regt		
10	XUYEN MOC	Op radio	Cpl/Sig	104 Sig sqn		
11	XUYEN MOC	Interpreter		Det 1 Div Int		
12	DUC THANH	LO	Capt/Lt	C sqn 1 Armd Regt		
13	DUC THANH	Op radio	Cpl/Sig	104 Sig sqn		
14	DUC THANH	C1 Op	Sgt	Det 1 Div Int		
15	DUC THANH	Interpreter		Det 1 Div Int		
16	LONG LE	LO	Capt/Lt	4 RAR/NZ (ANZAC)		
17	LONG LE	Op radio	Cpl/Sig	104 Sig sqn		
18	LONG LE	C1 Op	Sgt	Det 1 Div Int		
19	LONG LE	Interpreter		Det 1 Div Int		
20	DAT DO	LO	Capt/Lt	A sqn 3 Cav Regt		
21	DAT DO	Op radio	Cpl/Sig	104 Sig sqn		
22	DAT DO	Interpreter		Det 1 Div Int		

RESTRICTED

AMENDMENT NO 9  
DATED 20 JUL 71

RESTRICTED

I1.1-2

APPENDIX 1

(a)	(b)	(c)	(d)	(e)	(f)	(g)
23	BIEN HOA 3rd Bde	LO	Capt/Lt	1 Fd sqn		
24	" "	Op radio (3)	Cpl/Sig	104 Sig sqn		
25	BEARCAT (RTAVF)	LO	Capt/Lt	4 RAR/NZ(ANZAC)		
26	" "	Op radio (3)	Cpl/Sig	104 Sig sqn		
27	XUAN LOC (LONG KHANH)	LO	Capt/Lt	3 RAR/A sqn 3 Cav Regt		
28	" "	Op radio (3)	Cpl/Sig	104 Sig sqn		
29	NUI DAT Det AFV Pro Unit	Garrison Military Police	Gnr	12 Fd Regt		
30	" "	" "	Spr	1 Fd sqn		
31	" "	" "	Pte	3 RAR		
32	" "	" "	Pte	4 RAR/NZ(ANZAC)		
33	Pearson Centre	Assistant	Tpr/Cfn	A sqn 3 Cav Regt		
34	" "	Supervisor	Sgt	HQ Coy		
35	VUNG TAU Det AFV Pro Unit	MP duties	Gnr	12 Fd Regt		
36	" "	" "	Cpl	1 Fd sqn		
37	" "	" "	Cpl	17 Const sqn		
38	" "	" "	Cpl	17 Const sqn		
39	" "	" "	Cpl	3 RAR		
40	" "	" "	Pte	3 RAR		
41	" "	" "	Cpl	4 RAR/NZ(ANZAC)		
42	" "	" "	Cpl	4 RAR/NZ(ANZAC)		
43	" "	" "	Pte	4 RAR/NZ(ANZAC)		

AMENDMENT NO 9  
DATED 20 JUL 71

RESTRICTED

RESTRICTED

1 I 2-1

APPENDIX 2  
TO ANNEX I  
TO CHAPTER 1

RESPONSIBILITIES OF 1 ATF LOs

1. The Liaison responsibilities of 1 ATF LOs are as follows:
  - a. The briefing of the commander's advisors and staff, at the headquarters to which the LO is attached, on 1 ATF operations affecting the particular unit, formation or district.
  - b. The briefing of the commander and staff of 1 ATF, on operations of the unit, formation or district to which the LO is attached.
  - c. Providing on 1 ATF Command Net or by telephone, intelligence information of value to 1 ATF, when this has not already been the subject of a formal signal.

Note: 1. The intention implicit in this direction is that, the LO is to actively gather intelligence which is likely to assist 1 ATF operations.

2. Reciprocally, he is to disseminate info gleaned from 1 ATF sources which may be of intelligence value to the organisation to which he is attached. Such info is to be passed quickly.
  - d. Processing clearances, including boundary clearances, granting of AOs and extensions between 1 ATF and the unit, formation or district to which the LO is attached.
  - e. Processing of ground clearances for mortar, artillery fire, and airstrikes, for targets within or adjacent to the AO or TAOR of the unit, formation or district to which attached.
  - f. Providing locstats to HQ 1 ATF of friendly units, sub-units. Reciprocal information on 1 ATF units is to be provided.
  - g. Forwarding to HQ 1 ATF copies of operation orders and instructions issued by the organisation to whom the LO is attached.
2. The administrative responsibilities of 1 ATF LOs include:
  - a. The local administration of the detachment including its security, living and working conditions, discipline, morale and anti-malarial precautions.
  - b. Security of all classified material issued to the LO and to his detachment.
  - c. Maintenance and control of vehicle and driver when allotted.
  - d. Security and condition of weapons and other stores issued to the detachment or its members individually.

AMENDMENT NO 9  
DATED 20 JUL 71

RESTRICTED

RESTRICTED

113-1

APPENDIX 3  
TO ANNEX I  
TO CHAPTER 1

1 ATF LIAISON OFFICER'S REPORT

FOR PERIOD..... TO.....

SUBMITTED BY.....

1. Any change in key staff?
  
2. Changes in Unit/Sub Unit/ MATTs locs and tasks?
  
3. Operations.
  - a. Forecast?
  
  - b. Current Details?
  
  - c. Results?
  
4. Other Events of Interest or Significance?

AMENDMENT NO 9  
DATED 20 JUL 71

RESTRICTED

RESTRICTED

113-2

APPENDIX 3

5. Intelligence.

a. En Ops?

b. Infiltrations?

c. Kidnapping, Abductions or Murders?

d. Hoi Chanh, PWs?

e. Payments of Tax to VC?

f. Phung Hoang Successes?

AMENDMENT NO 9  
DATED 20 JUL 71

RESTRICTED

RESTRICTED

APPENDIX 3

113-3

g. Known Recruitment by VC?

6. Evidence of Successful Psy Ops?

a. En

b. Friendly.

7. Civic Action.

a. VN

b. FWMAF.

AMENDMENT NO 9  
DATED 20 JUL 71

RESTRICTED



RESTRICTED

APPENDIX 3

113-4

8. An overall comment on Int Reports for the previous week.

9. Liaison Problems encountered in District/Fmm.

..... Signature .....  
(Date) Rank .....  
.....  
(Name in BLOCKS)

AMENDMENT NO 9  
DATED 20 JUL 71

RESTRICTED

RESTRICTED

1 I 4-1

APPENDIX 4  
TO ANNEX I  
TO CHAPTER 1

PROPOSED CHANGEOVER OF DETACHED PERSONNEL

.....(Unit)

Reference: A. HQ 1 ATF SOPs Chapter 1 Annex I.

1. Approval is requested for the following changeover of detached personnel:

a. Currently detached:

Number:..... Rank ..... Name:.....

b. Location: .....

2. Proposed replacement:

Number:..... Rank:..... Name:.....

3. It is proposed to effect the changeover of the above personnel on:

Date: .....

(Signature) .....

(Rank) .....

(Appt) .....

HQ 1 ATF USE ONLY

1. The above changeover is APPROVED/NOT APPROVED and detachment Instruction No T is attached.

( )  
Maj  
DAAG

Remarks: .....  
.....  
.....  
.....  
.....

AMENDMENT NO 9  
DATED 20 JUL 71

RESTRICTED

RESTRICTED

APPENDIX 6 TO  
ANNEX D TO  
CHAPTER 1

VC INSTALLATION REPORT

- |         |  |
|---------|--|
| ALFA    | <ol style="list-style-type: none"><li>1. Type of installation.</li><li>2. Date/Time of finding.</li><li>3. Callsign Locating.</li></ol>  |
| BRAVO   | Location.  |
| CHARLIE | <ol style="list-style-type: none"><li>1. Size and shape of installation.</li><li>2. Number and size of pits, bunkers etc.</li><li>3. Thickness of OHP.</li><li>4. Entry/Exit routes.</li></ol> |
| DELTA   | <ol style="list-style-type: none"><li>1. Age of system.</li><li>2. Last used.</li><li>3. Condition of system.</li></ol>  |
| ECHO    | <ol style="list-style-type: none"><li>1. Eqpt/stores located in system.</li><li>2. Method of disposal.</li></ol>   |
| FOXTROT | <ol style="list-style-type: none"><li>1. Mines/booby traps laid - type.</li><li>2. Where laid.</li><li>3. Method of disposal.</li></ol>  |
| GOLF    | <ol style="list-style-type: none"><li>1. Was installation destroyed.</li><li>2. Method of destruction.</li><li>3. If not, when (est date/time).</li></ol>                                      |

AMENDMENT NO 9  
DATED 20 JUL 71

RESTRICTED

99

MESSAGE FORM

ROUTINE	ROUTINE	270630	Z (JUL 71)	R572/1/18
FROM	:	1 ATF		RESTRICTED
TO	:	DISTRIBUTE AS PER SOPS		SD1295

1 ATF SOPS CORRIGENDUM TO AMENDMENT NO 9 DATED 20 JUL 71 (!)  
 MANUSCRIPT AMENDMENT PAGE I1-1 CLN DELETE ANNEX I TO CHAPTER 7  
 INSERT ANNEX I TO CHAPTER 1

PAGE 1 OF 1 PAGES CLASSIFIED YES HARDING CLERK EBONY 25



CAPT