

GME

GX750 VHF marine radio

with remote full function LCD controller microphone



INSTRUCTION MANUAL

CONTENTS

WARNING/SAFETY INFORMATION.....	3
OPERATOR QUALIFICATIONS.....	3
INTRODUCTION.....	3
FEATURES.....	3
SUPPLIED WITH.....	4
RANGE.....	4
CONTROLS.....	4
OPERATION.....	5
On/Off.....	5
Volume.....	5
Adjusting the squelch.....	6
Channel selection.....	6
Keypad lock.....	7
Transmitting.....	7
Channel 16.....	7
Display backlighting.....	8
High/Low power selection.....	8
Working channel memories.....	8
Dual Watch key (DW).....	8
Dual Watch features.....	9
Triple Watch key (TW).....	9
Triple Watch features.....	10
Scanning.....	11
Scanning features.....	11
INSTALLATION.....	12
Selecting a location.....	13
Installing the main unit.....	13
Antenna installation.....	15
SPECIFICATIONS.....	16
Electrical.....	16
Mechanical.....	17
Environmental.....	17
INTERNATIONAL VHF MARINE CHANNELS.....	18
STANDARD COMMUNICATIONS WARRANTY AGAINST DEFECTS.....	19

WARNING/SAFETY INFORMATION

- The GX750 is a radio transmitting device.
- When transmitting, keep any part of your head or body more than 20 cm from the antenna.
- Do not transmit near electrical blasting equipment or in explosive atmospheres.
- Do not allow children to operate a radio transmitter unsupervised.

OPERATOR QUALIFICATIONS

Any person in Australia operating a VHF marine radio should possess at least a Short Range Radio Operators Certificate of Proficiency (SROCP). Alternatively, operators may obtain a Long Range Radio Operators Certificate of Proficiency (LROCP), which covers the operation of both VHF and MF/HF equipment.

Many TAFEs and marine organisations offer courses leading to examination for the SROCP and LROCP although such courses are not compulsory. Persons wishing to obtain the SROCP or LROCP should first purchase a copy of the Maritime Radio Operator Handbook which is essential reading for every boat owner in Australia.

The Australian Maritime College (AMC) provides the marine examination and certificate service on behalf of the Australian Communications and Media Authority (ACMA). The AMC can provide the details of organisations and individuals offering courses and or conducting exams.

For further information visit: www.amc.edu.au

INTRODUCTION

Congratulations. You have just purchased one of the most technically advanced VHF marine radios in the world.

The GME GX750 is a VHF radio designed to operate in the 156–163 MHz marine band. The GX750 has a number of enhanced features including full function LCD controller microphone, user programmable Channel Scanning, Dual Watch and Triple Watch functions and two programmable 'Instant' channel memories.

With its compact size and IPX7 design it can easily be installed into almost any mounting location in your flybridge or cabin.

The GX750 is designed in Australia at our Sydney facility.

FEATURES

- Full Function LCD Controller Microphone
- Compact Modular IPX7 Design
- Selectable International, USA, and Canadian Channel Sets
- Selectable USA and Canadian Weather Channels
- Dual Watch and Triple Watch with Programmable Priority Channel
- Programmable Channel Scanning
- Selectable Power 25/1 watt
- Two Working Channel Memories
- Adjustable Digital Squelch

SUPPLIED WITH

GX750 main unit	S0239 to FME adaptor (AD513)
GX750 LCD controller microphone (MC750B/W)	8 pin panel socket (MK013B/W)
Mounting hardware	DC power lead (LE029)
Microphone bracket (MB210B/W)	500 mm interconnecting lead (LE106)
Microphone clip (MB209B/W)	Instruction manual
	Cable Tie

RANGE

The range of VHF transmissions depend on antenna height, transmitter power and the terrain over which the signals pass. Ship to ship communications should be possible over at least 8 nautical miles and up to about 27 nautical miles. Ship to shore ranges will often be greater due to the increased height of the shore antenna and communications of 25 to 50 nautical miles are possible.

CONTROLS

Rear Panel

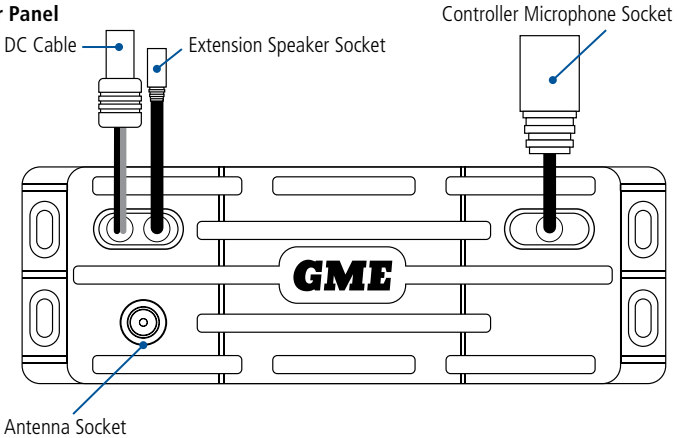

LCD Display

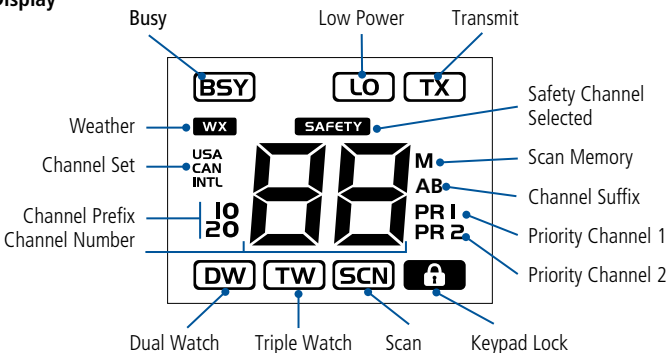

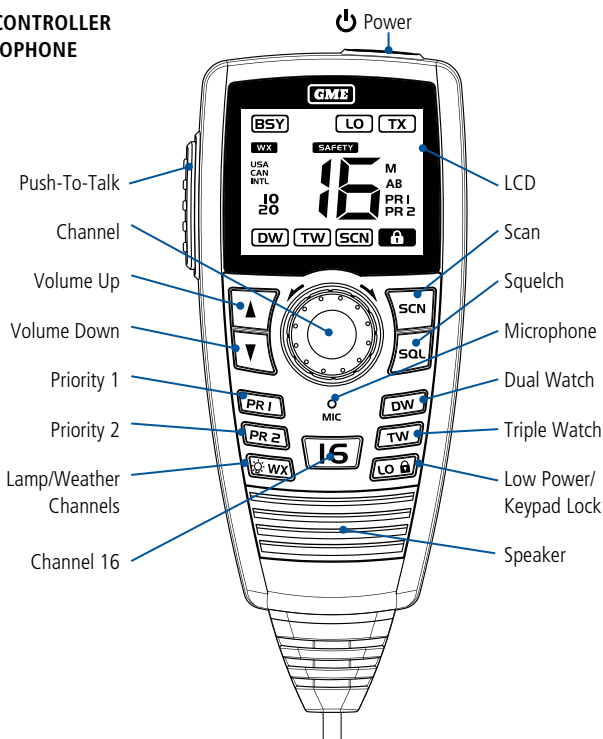

LCD CONTROLLER MICROPHONE







OPERATION

ON/OFF

To turn the GX750 ON, press and hold the  key.

To turn the GX750 OFF, press and hold the  key.

VOLUME

Press the  or  keys to adjust the volume. Press the  key to increase the volume or the  key to decrease the volume. The volume level is shown on the display as 01 (minimum) to 19 (maximum).

NOTE: When adjusting the volume, the left digit is deliberately displayed smaller to minimise confusion with the channel number.



Minimum Volume (01)



Maximum Volume (19)

NOTE: At minimum volume setting there is still sufficient volume to be heard in a quiet cabin environment.

ADJUSTING THE SQUELCH

To open the squelch, briefly press the **SQL** key. A low beep will be heard and the squelch will open. Briefly press the **SQL** key again to close the squelch. A high beep will be heard and the squelch will be restored to its preset level.

Setting the squelch preset level

The preset squelch level can be adjusted to suit local conditions. If you are in an electrically noisy location or unwanted weak signals keep opening the squelch, you can adjust the squelch setting so that the GX750 remains quiet. Note that increasing the preset squelch level will mean that stronger signals will be required to overcome the squelch and may result in missed calls from weaker signals. The best setting is the minimum one required to keep the receiver quiet.

To alter the preset squelch setting, press and hold the **SQL** key until a high beep is heard.

The present squelch setting will be displayed in digits from -0 (minimum) to -9 (maximum) squelch. While in this mode, briefly rotate the channel control left or right to increase or decrease the squelch level respectively as required. Press the **SQL** key again to exit the squelch setting mode (or wait 5 seconds and it will time out automatically). A low beep will be heard.



Minimum Squelch (-0)

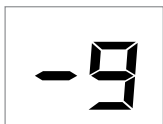

Maximum Squelch (-9)

CHANNEL SELECTION

Standard Marine Channels

Select the required channel by rotating the channel control left or right. The selected channel number is displayed.

Channel sets

The GX750 is programmed with three channel sets – International, USA and Canada. These channel sets support various channel and frequency allocations for other parts of the world. When operating in Australia or New Zealand, the International channel set should be selected.

Once you have selected the required channel set for your location, you should not need to change it again unless you have moved to another country.

To select the required channel set

Switch the GX750 OFF

- Press and hold the **16** key while switching the GX750 ON again.
- Channel 16 will be selected and the presently selected channel set will flash on the display as INTL, USA or CAN.
- Briefly press the **16** key to cycle through the channel set selections in the following order:

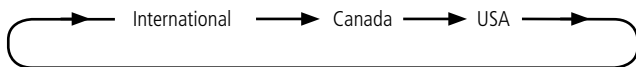

The selected channel set becomes active immediately.

- Once the required channel set is selected, hold the **16** key to return to normal operation.

NOTE: The radio will automatically return to normal operation after 20 seconds.

NOTE: Weather channels are also available when the USA and Canada channel sets are selected.





Weather Channels

Weather channels are available only when the USA or Canadian channel sets have been selected. There are no allocated weather channels in the International channel set.

To access the weather channels while in the USA or Canada channel set, press and hold **WX**. The 'WX' icon is displayed. Now rotate the channel control to select from the available weather channels. To return to normal channels press and hold **WX** again. The 'WX' icon will disappear.

KEYPAD LOCK

The keypad lock prevents accidental key presses from altering the operation of the radio unexpectedly.

To lock the keypad, press and hold the  key. The  symbol will be displayed and all keys are disabled except for the , **16**, **Volume**, **PTT**,  and  keys.

To unlock the keypad press and hold the **LOCK** key again. The  symbol will disappear and the keypad will be enabled.

TRANSMITTING

To transmit, press the **PTT** (Push to Talk) on the microphone. Hold the microphone about 3 – 5 cm from your mouth and speak at a normal voice level. The microphone is quite sensitive so it is not necessary to raise your voice or shout. Release the **PTT** when you have finished talking.

Time-Out-Timer

Transmission time is controlled by a time-out timer. If the **PTT** is held for more than 5 minutes, a low beep will be heard and the transmitter will be temporarily disabled to prevent accidental jamming of the channel frequency. To reset the timer simply release the **PTT**.

NOTE: The transmitter is permanently disabled on CH 70. If the **PTT** is pressed on CH 70, a low beep will be heard and the **PTT** will be ignored.

CHANNEL 16

Briefly press the **16** key to switch straight to channel 16. The 'SAFETY' icon will be displayed, all previous control settings (such as scanning or low transmitter power) will be cancelled and the radio will be restored to normal operation with high transmitter power selected. Press the **16** key again to return to the selected channel.

DISPLAY BACKLIGHTING

The LCD display and keys are backlit for easy viewing at night.

Brightness Adjustment

To set the brightness of the LCD backlighting, briefly press the  key. Each press will cycle through the following brightness settings.



Colour Selection

To change the backlight colour, press and hold the channel control. Each press will toggle the backlighting between white and red.

NOTE: When the red backlight is selected, the **16** key remains backlit in white

HIGH/LOW POWER SELECTION

To switch between High and Low transmit power, briefly press the **LO** key. A high beep indicates that High power is selected (25 watts) while a low beep indicates Low power is selected (1 watt). When low power is selected 'LO' is displayed.

NOTE: Selecting channel 16 automatically resets the transmitter to high power.

WORKING CHANNEL MEMORIES

The GX750 has two dedicated priority channel memories that allow you to store and recall two often-used channels. These memories are accessed using keys labelled **PR1** and **PR2**. **PR1** is also used as the priority channel for the Triple Watch function (see feature description later in this manual).

Storing Priority Memories (PR1/PR2)

To store a channel in the PR1 or PR2 memory, select the required channel using the channel control, then press and hold the **PR1** or **PR2** key. The channel number will flash then a high beep will be heard as the channel is stored.

Recalling Priority Memories (PR1/PR2)

Briefly press the **PR1** or **PR2** key. The radio will switch immediately to the channel stored in that memory and 'PR1' or 'PR2' is displayed. If the radio was scanning the scan will be cancelled.

DUAL WATCH KEY (DW)

The Dual Watch function is a two-channel scan feature where the GX750 switches between channel 16 and any other selected channel. This feature allows you to monitor a working or club channel while still being able to receive important broadcasts on channel 16.

Example of the Dual Watch sequence

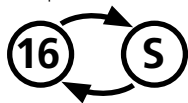

(S = selected channel)

To use the Dual Watch function, select your preferred operating channel – either by rotating the channel control or by selecting one of the stored **PR1** or **PR2** memories – then press the **DW**

key. A high beep will be heard and the 'DW' icon will appear on the display. The GX750 will now monitor both the selected channel AND channel 16 by alternating equally between them.

To cancel the Dual Watch

Briefly press the **DW** key to return to normal operation. A low beep will be heard.

DUAL WATCH FEATURES

If a signal appears on the selected channel

Scanning will pause on the selected channel but channel 16 will continue to be monitored every 2 seconds resulting in short breaks in the reception of the selected channel. During this time the **PTT** may be pressed for normal transmissions on the selected channel (monitoring of channel 16 pauses while transmitting). Once the selected channel has become inactive for 5 seconds the Dual Watch function will resume.

If a signal appears on channel 16

The radio will switch immediately to channel 16 and the selected channel will no longer be monitored because channel 16 has priority. During this time the **PTT** may be pressed for normal transmissions on channel 16. Once channel 16 has become inactive for 5 seconds the Dual Watch function will resume.

To transmit on the selected channel while Dual Watching

Simply press the **PTT**. The Dual Watch function will pause and the radio will transmit on the selected channel. Dual Watch will then resume 5 seconds after all activity has ceased on the channel.

To transmit on channel 16 while Dual Watching

Press the **16** key to switch to channel 16. Dual Watch will be cancelled and the radio will switch straight to channel 16 and the 'SAFETY' icon will be displayed. Now press the **PTT** and transmit in the usual way. When your conversation has ended, press the **DW** key to resume Dual Watching.

To change the working channel while Dual Watching

While Dual Watching, simply rotate the channel control to select another working channel. Alternatively you can select one of the stored **PR1** or **PR2** memories. Dual Watching automatically continues using the newly selected channel.

TRIPLE WATCH KEY (TW)

Triple Watch is an extension of the Dual Watch feature. It allows the GX750 to monitor channel 16, a selected working channel AND the PR1 channel memory. Each channel is scanned equally for signals with priority given first to channel 16, then the PR1 channel and lastly the selected channel.

Example of the Triple Watch sequence

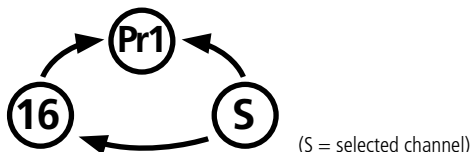

When Triple Watch is selected, the 'TW' icon is displayed.

To use the Triple Watch mode, first program your priority channel into the PR1 memory, then select your preferred working channel by rotating the channel control. Now press the **TW** key. A high beep will be heard and the 'TW' icon will be displayed. The GX750 will now monitor channel 16, the PR1 channel and the selected channel by alternating equally between them.

To cancel Triple Watch

Press the **TW** key to return to normal operation. A low beep will be heard.

TRIPLE WATCH FEATURES

If a signal appears on channel 16

The radio will switch immediately to channel 16 and '16' will be displayed. At this point the selected channel and the priority channel are no longer being monitored because channel 16 has highest priority. During this time the **PTT** may be pressed for normal transmissions on channel 16. Once channel 16 has become inactive for 5 seconds the Triple Watch function will resume.

If a signal appears on the Priority channel

Scanning will pause on the priority channel BUT channel 16 will continue to be monitored every 2 seconds (the selected channel is not monitored). During this time the **PTT** may be pressed for normal transmissions on the priority channel (monitoring of channel 16 pauses while transmitting). Once the priority channel has become inactive for 5 seconds Triple Watch will resume.

If a signal appears on the selected channel

Scanning will pause on the selected channel BUT channel 16 and the priority channel will continue to be monitored every 2 seconds. During this time the **PTT** may be pressed for normal transmissions on the selected channel (monitoring of channel 16 and the priority channel pauses while transmitting). Once the selected channel has become inactive for 5 seconds the Triple Watch will resume.

To transmit on the selected channel while Triple Watching

Simply press the **PTT**. The Triple Watch function will pause during the transmission and remain paused until 5 seconds after all activity has ceased on the selected channel. Triple Watch will then resume.

To transmit on the Priority channel while Triple Watching

Briefly press the **PR1** key. Triple Watch will be cancelled and the priority channel will be selected. Now press the **PTT** and transmit in the usual way. When your conversation has ended, press the **TW** key to return to the Triple Watch function.

To transmit on channel 16 while Triple Watching

Press the **16** key. Triple watch will be cancelled and the radio will switch straight to channel 16. Now press the **PTT** and transmit in the usual way. When your conversation has ended, press the **TW** key to return to the Triple Watch function.

SCANNING

The scan function allows the GX750 to scan a series of user selected channels looking for activity. Scanning is done in an ascending sequence at a rate of 10 channels per second.

Channels can be selected and stored for scanning from any of the available channels.

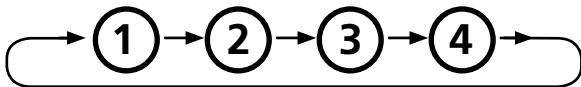

e.g. Scanning channels 1, 2, 3 & 4

NOTE: The transmitter is disabled while scanning. If the **PTT** is pressed, a low beep will be heard and the **PTT** is ignored.

To add or remove scan channels

Channels that are stored in the scan memory will display 'M' to the upper right of the channel number. To add or remove channels from the scan memory, first select the required channel by rotating the channel control.

- If 'M' is NOT displayed, press and hold the **SCN** key to add the channel to the scan memory. The channel number will flash, the radio will give a high beep and 'M' will appear.
- If 'M' IS displayed, press and hold the **SCN** key to remove the channel from the scan memory. The channel number will flash, the radio will give a low beep and 'M' will disappear.

To begin scanning

Briefly press the **SCN** key. The GX750 will scan upwards through the stored channels and the display will show rapidly changing channel numbers. If a signal is located, scanning will pause and the receiver will remain on that channel until 5 seconds after the signal has gone. Scanning will then resume.

To stop scanning

Briefly press the **SCN** key again. The radio will return to the last selected channel.

SCANNING FEATURES

If the scan is paused on a busy channel and you wish to remain there;

Briefly press the **SCN** key. The scan will be cancelled and the radio will remain on that channel. To resume scanning, briefly press the **SCN** key again.

If the scan is paused on a busy channel and you wish to skip over that channel

Briefly rotate the channel control. The scan will resume from the next channel in sequence.

If the scan is paused on a busy channel and you wish to transmit on that channel

Simply press the **PTT**. Scanning will be cancelled and the radio will remain on that channel.

NOTE: If the **PTT** is pressed at any other time while scanning, a low beep will be heard and the **PTT** will be ignored.

To switch immediately to channel 16

Briefly press the **16** key. Channel 16 will be selected, scanning will be cancelled and the radio will be restored to normal operation with high transmitter power selected.

To switch immediately to a stored working channel (PR1 or PR2)

Briefly press the **PR1** or **PR2** key. Scanning will be cancelled and the radio will switch to the channel stored in the selected memory.

SCANNING NOTES

1. Each channel set has its own independent scan memory. i.e. Scan channels stored under the International channel set can be different to those stored under the USA or Canadian channel sets.
2. If the GX750 is switched off while it is scanning, it will resume scanning automatically when it is switched ON again.
3. A minimum of 2 channels is required in the scan memory before scanning is allowed. If there are less than 2 channels in the scan memory, pressing the **SCN** key will give a low beep and the scan will be ignored.
4. The **PTT** and **LO** keys are disabled while scanning

Scanning with Dual Watch

If Dual Watch is selected while scanning, the 'DW' and 'SCN' icons will be displayed and channel 16 will be inserted into the scan every 2 seconds.

Scanning with Triple Watch

If Triple Watch is selected while scanning, the 'TW' and 'SCN' icons will be displayed and both channel 16 and the PR1 channel will be inserted into the scan every 2 seconds.

INSTALLATION

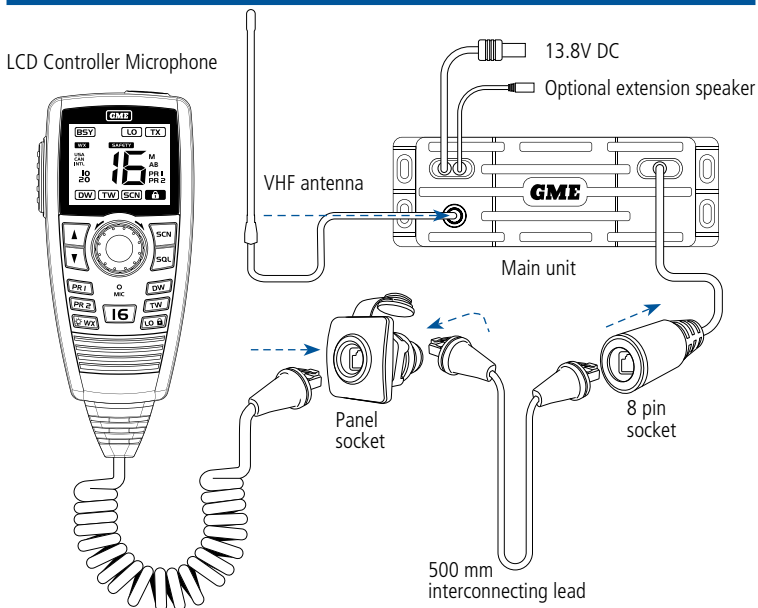

NOTE: Your GX750 is designed for connection to negative earth electrical systems only.

SELECTING A LOCATION

It is advisable to spend a little time selecting the best location for your GX750. The radio is a modular design which allows the main unit to be discretely mounted out-of-sight behind the dashboard or control panel. The chosen location should provide sufficient space to reach the connectors and allow some airflow for the heat sink. The GX750 is supplied with a 500 mm interconnecting lead, so select a location that is within 500 mm of the panel socket that will connect to the LCD controller microphone.

For larger vessels where the main units may need to be mounted further away, a 6 meter inter-connecting cable is available as an accessory (LE107).

Keep the following points in mind when choosing a location

- The GX750 is designed to meet IPX7 standard. However we recommend you select a location that will minimise excessive exposure to continuous rain or spray.
- Select a location that won't expose your radio to continuous direct sunlight which could cause overheating.
- Ensure the location allows a free flow of air around the heat sink on the main unit.
- The LCD Controller Microphone should be readily accessible from the normal steering or driving position. If required, an extension speaker can be installed to provide sound in other parts of your vessel e.g. inside the cabin. The extension speaker connects to the main unit
- Components and currents in the radio create magnetic fields. To avoid interference to compasses, ships autopilot sensors etc, the GX750 should be mounted at least 300 mm from such devices.

INSTALLING THE MAIN UNIT

The main unit is designed to be installed to a flat surface using four bolts or screws (depending on the mounting surface material). First choose the desired mounting location for the LCD controller microphone and panel socket as these will determine the approximate location for the main unit. The main unit will need to be installed within 500 mm of the panel socket.

Once the location has been determined, simply place the main unit in the correct location and mark the screw holes with a pen or pencil. Drill the holes while being mindful of any objects that may be behind the panel. Fix the main unit with stainless steel screws or bolts.

Note that the 8 pin socket is quite heavy and once installation is completed, should be supported using a cable tie as shown.

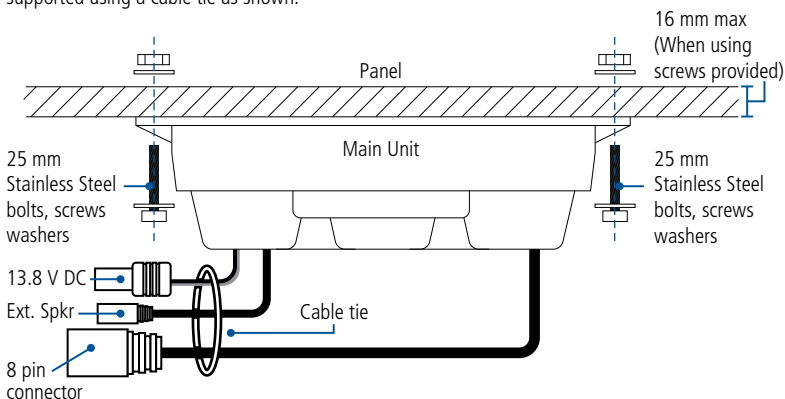

DC connections

Connect the **RED** power lead to the Positive (+) side of the battery or to an accessory point in the vessel or vehicle's fuse box.

Connect the **BLACK** power lead to the Negative (-) side of the battery or to a ground point in your vessel or vehicle.

IMPORTANT: The RED power lead is fitted with a 10 Amp fuse. If the fuse blows, use only a standard 10 Amp (3AG) fuse as a replacement. Use of a higher rated fuse or a slow-blow type could result in damage to your radio which would void the warranty.

Panel socket

The panel socket should be mounted on the dashboard next to the LCD controller microphone mounting location. Mark the correct location for the socket, checking that there is a clear space behind the panel. Drill a 28 mm hole in the dashboard.

Slide the PCB into the rear of the socket ensuring it is correctly located in the guides (it may be easier to fit into the guides now rather than after the socket is mounted).

Insert the panel socket through the hole in the panel from the front and secure it using the washer and castellated nut. Hand-tighten firmly - do not over tighten.

Finally, insert the 'O' ring into the rear cap and screw into place to secure the PCB. Hand-tighten firmly.

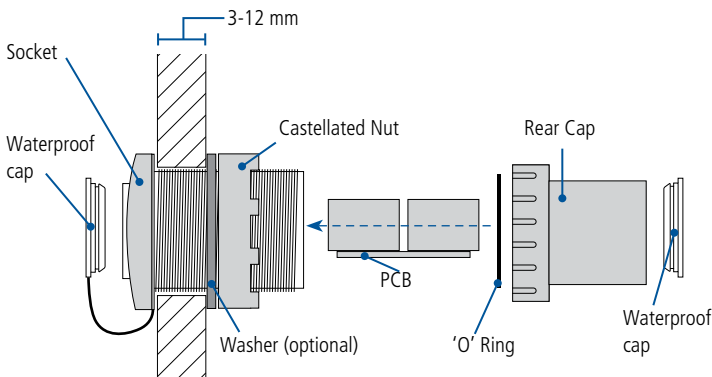

Connect the 8 pin socket on the main unit to the 8 pin connector at the rear of the panel socket using the 500 mm interconnecting lead. Fit the cable grommets to provide protection from water ingress.

LCD controller microphone

Position the microphone cradle in the desired location and mark the three screw holes. Drill the holes and fix the bracket with screws. Slide the microphone downwards into the cradle.

Plug the 8 pin connector into the front of the panel socket and fit the grommet to protect against water ingress.

NOTE: A standard microphone clip is also supplied as an alternative to installing the full cradle. The mounting clip can be screwed to the panel and fixed with '3M' double-sided adhesive tape (not included).

LCD controller microphone cradle

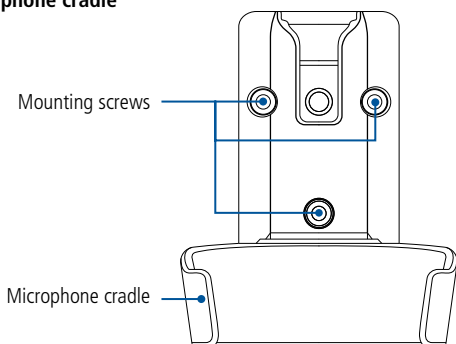

ANTENNA INSTALLATION

It is essential to select a good quality, high efficiency, VHF Marine antenna. A poor quality antenna or one not designed for the specific frequency band you are using will give very poor performance.

GME have a large range of suitable VHF Marine antennas to suit most installations and applications. We recommend you contact your local dealer for advice, or visit gme.net.au.

Your GX750 is fitted with an 'FME' antenna socket. An 'FME' to 'SO239' adaptor is also included (AD513).

If your VHF antenna cable is fitted with an 'FME' connector you may connect it directly to the 'FME' socket on the radio. Simply screw the 'FME' connector onto the radio's 'FME' socket and tighten the nut using a small spanner or pliers.

Alternatively, if your antenna cable is fitted with a standard PL259 connector, you will need to use the 'FME' adaptor to connect the antenna to the radio. Simply screw the adaptor onto the antenna socket on the rear of the radio and tighten. Attach the 'PL259' connector to the adaptor.

NOTE: The antenna connector is not waterproof.

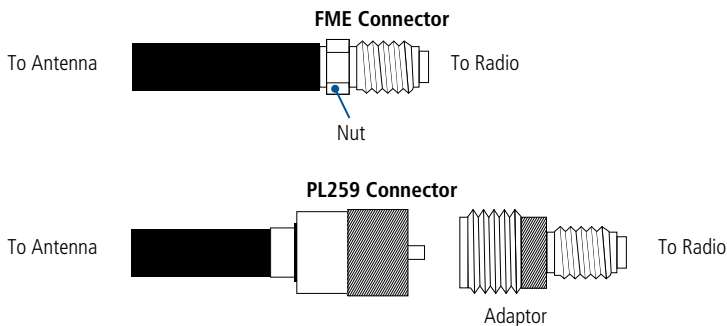

Extension speaker

If required, an extension speaker (SPK45 or similar) may be installed to improve sound levels in noisy environments or in locations further away from the steering or driving position.

Noise suppression

The inherent design of VHF FM radios results in a high level of resistance to ignition and electrical interference. However in some installations it may be necessary to take additional steps to help reduce or eliminate noise interference. During installation, try to route the DC battery leads, the antenna lead or any accessory wires away from the engine compartment, ignition or alternator wiring. If the noise continues, it may be necessary to fit a suppression kit. Contact your local marine dealer for more information.

Similarly, if the interference you are experiencing is from other electronic equipment such as a depth sounder, try to keep the depth sounder's DC leads and transducer cable well away from your GX750's wiring.

SPECIFICATIONS*

ELECTRICAL

General

Complies with: AS/NZS4415.2.2003

Frequency Range: 155 – 165 MHz

Channel Spacing: 25 kHz

Modulation: FM

Channels Sets: International, USA, Canada, USA/Canada weather channels

Supply Voltage: 12 volt nominal, 10.5 – 15.6 volt max. range, negative earth

Frequency Stability: ± 1.5 kHz over environment extremes

Scan Speed: 100 ms/channel (10 channels/sec)

Transmitter

Power Output: High: 25 watts max, Low: 1 watt max

Spurious Emissions: < -75 dBc

Frequency Deviation: ± 5 kHz max +20 dB limiting @ 1 kHz

Frequency Response: + 6 dB per octave, 300 Hz – 3 kHz, +1 - 3 dB

Demodulated S/N: > 50 dB weighted

Current Consumption: High power: < 4.4 amps, Low power: 1.1 A

Receiver

IF Frequencies: 1st: 21.4 MHz, 2nd: 450 kHz

Sensitivity: -120 dBm for 12 dB SINAD unweighted

Squelch Sensitivity: Adjustable, 10 preset levels

Spurious Rejection: > 70 dB

Intermodulation Rejection: > 75 dB

Adjacent Channel Rejection: > 74 dB

Blocking Rejection: > 100 dB

RF Bandwidth: < 4 MHz

Switching Bandwidth: > 10 MHz

Frequency Response: -6 dB per octave de-emphasis, 300 Hz – 3 kHz, +1 - 3 dB

Audio Output Power: 3 watts average into external 4 Ohm speaker

2 watts average into internal speaker

Audio SN: > 50 dB weighted

Conducted Spurious Emission: < -70 dBm

Current Consumption: Muted: < 280 mA, Full volume: 470 mA

MECHANICAL

Dimensions: Main unit, 190 (W) x 65 (H) x 50 (D) mm

Mounting face, 93 (W) x 65 (H) mm

LCD microphone, 150 (H) x 71 (W) x 47 (D) mm

Weight: Main unit, 545 grams

LCD microphone, 240 grams

ENVIRONMENTAL

Temperature Range: - 10°C to + 55°C

Vibration: MIL STD 810E, procedure I3.4.8

Solar Radiation: Case UV stabilised

Water and Dust Resistance: IPX7 excluding external cabling

Compass Safe Distance: 300 mm

External connections

Microphone: 8 pin socket

DC Supply: 2 pin socket

External Speaker: 3.5 mm phono line socket

*Specifications are typical unless otherwise indicated and may be subject to change without notice or obligation

INTERNATIONAL VHF MARINE CHANNELS

Channel	Simplex	TX Frequency	RX Frequency	Comment
01		156.050	160.650	Public correspondence
02		156.100	160.700	Public correspondence
03		156.150	160.750	Public correspondence
04		156.200	160.800	Public correspondence
05		156.250	160.850	Public correspondence
06	X	156.300	156.300	Intership
07		156.350	160.950	Public correspondence
08	X	156.400	156.400	Intership
09	X	156.450	156.450	Intership
10	X	156.500	156.500	Intership
11	X	156.550	156.550	
12	X	156.600	156.600	
13	X	156.650	156.650	Intership
14	X	156.700	156.700	
15	X	156.750	156.750	Intership
16	X	156.800	156.800	Distress, Safety, Calling
17	X	156.850	156.850	Intership
18		156.900	161.500	Public correspondence
19		156.950	161.550	Public correspondence
1019	X	156.950	156.950	** Available from Jan 1 st 2017
2019	X	161.550	161.550	** Available from Jan 1 st 2017
20		157.000	161.600	Public correspondence
1020	X	157.000	157.000	** Available from Jan 1 st 2017
2020	X	161.600	161.600	** Available from Jan 1 st 2017
21		157.050	161.650	Public correspondence
22		157.100	161.700	Public correspondence
23		157.150	161.750	Public correspondence
24		157.200	161.800	Public correspondence
25		157.250	161.850	Public correspondence
26		157.300	161.900	Public correspondence
27		157.350	161.950	Public correspondence
28		157.400	162.000	Public correspondence
60		156.025	160.625	Public correspondence
61		156.075	160.675	Public correspondence
62		156.125	160.725	Public correspondence
63		156.175	160.775	Public correspondence
64		156.225	160.825	Public correspondence
65		156.275	160.875	Public correspondence
66		156.325	160.925	Public correspondence
67	X	156.375	156.375	Intership
68	X	156.425	156.425	
69	X	156.475	156.475	Intership
70	X	156.525	156.525	DSC Only (voice not allowed)
71	X	156.575	156.575	
72	X	156.625		Intership
73	X	156.675	156.675	Intership
74	X	156.725	156.725	
75	X	156.775	156.775	
76	X	156.825	156.825	
77	X	156.875	156.875	Intership
78		156.925	161.525	Public correspondence

1078	X	156.925	156.925	** Available from Jan 1 st 2017
2078	X	161.525	161.525	** Available from Jan 1 st 2017
79		156.975	161.575	Public correspondence
1079	X	156.975	156.975	** Available from Jan 1 st 2017
2079	X	161.575	161.575	** Available from Jan 1 st 2017
80		157.025	161.625	Public correspondence
81		157.075	161.675	Public correspondence
82		157.125	161.725	Public correspondence
83		157.175	161.775	Public correspondence
84		157.225	161.825	Public correspondence
85		157.275	161.875	Public correspondence
86		157.325	161.925	Public correspondence
87	X	157.375	157.375	
88	X	157.425	157.425	

****NOTE:** Additional channels will be released on January 1st 2017. Your GX750 is designed to support these channels. Please check the GX750 product page on the GME website in 2017 for details on how to obtain these channels.

STANDARD COMMUNICATIONS WARRANTY AGAINST DEFECTS

This warranty against defects is given by Standard Communications Pty Ltd ACN 000 346 814 (We, us, our or GME). Our contact details are set out in clause 2.7. This warranty statement only applies to products purchased in Australia. Please contact your local GME distributor for products sold outside of Australia. Local distributor details at: www.gme.net.au/export.

1. Consumer guarantees

- 1.1 Our goods come with guarantees that cannot be excluded under the Australian Consumer Law. You are entitled to a replacement or refund for a major failure and for compensation for any other reasonably foreseeable loss or damage. You are also entitled to have the goods repaired or replaced if the goods fail to be of acceptable quality and the failure does not amount to a major failure.
- 1.2 To the extent we are able, we exclude all other conditions, warranties and obligations which would otherwise be implied.

2. Warranty against defects

- 2.1 This warranty is in addition to and does not limit, exclude or restrict your rights under the Competition and Consumer Act 2010 (Australia) or any other mandatory protection laws that may apply.
- 2.2 We warrant our goods to be free from defects in materials and workmanship for the warranty period (see warranty table) from the date of original sale (or another period we agree to in writing). Subject to our obligations under clause 1.2, we will at our option, either repair or replace goods which we are satisfied are defective. We warrant any replacement parts for the remainder of the period of warranty for the goods into which they are incorporated.
- 2.3 To the extent permitted by law, our sole liability for breach of a condition, warranty or other obligation implied by law is limited.
 - (a) In the case of goods we supply, to any one of the following as we decide –
 - (i) The replacement of the goods or the supply of equivalent goods.
 - (ii) The repair of the goods.
 - (iii) The cost of repairing the goods or of acquiring equivalent goods.
 - (b) In the case of services we supply, to any one of the following as we decide –
 - (i) The supplying of the services again
 - (ii) The cost of having the services supplied again.
- 2.4 For repairs outside the warranty period, we warrant our repairs to be free from defects in materials and workmanship for three months from the date of the original repair. We agree to re-repair or replace (at our option) any materials or workmanship which we are satisfied are defective.

- 2.5 We warrant that we will perform services with reasonable care and skill and agree to investigate any complaint regarding our services made in good faith. If we are satisfied that the complaint is justified, and as our sole liability to you under this warranty (to the extent permitted at law), we agree to supply those services again at no extra charge to you.
- 2.6 To make a warranty claim you must before the end of the applicable warranty period (see warranty table), at your own cost, return the goods you allege are defective, provide written details of the defect, and give us an original or copy of the sales invoice or some other evidence showing details of the transaction.
- 2.7 Send your claim to:
 Standard Communications Pty Ltd.
 17 Gibbon Rd, Winston Hills, NSW 2153, Australia.
 Tel: (02) 8867 6000 Fax: (02) 8867 6199.
 Email: servadmin@gme.net.au
- 2.8 If we determine that your goods are defective, we will pay for the cost of returning the repaired or replaced goods to you, and reimburse you for your reasonable expenses of sending your warranty claim to us.



3. What this warranty does not cover

- 3.1 This warranty will not apply in relation to:
- (a) Goods modified or altered in any way.
 - (b) Defects and damage caused by use with non Standard Communications products.
 - (c) Repairs performed other than by our authorised representative.
 - (d) Defects or damage resulting from misuse, accident, impact or neglect.
 - (e) Goods improperly installed or used in a manner contrary to the relevant instruction manual; or
 - (f) Goods where the serial number has been removed or made illegal.

4. Warranty period

- 4.1 We provide the following warranty on GME and Kingray products. No repair or replacement during the warranty period will renew or extend the warranty period past the period from original date of purchase.

PRODUCT TYPE	WARRANTY PERIOD
27 MHz and VHF marine radios	1 year

 **1300 463 463**  **gme.net.au**

A division of Standard Communications Pty Ltd.
 Head Office: PO Box 96, Winston Hills, NSW 2153, Australia.
 New Zealand: PO Box 58446 Botany, Auckland, 2163, NZ. T: (09) 274 0955.
 All international enquiries email: export@gme.net.au