

# Assembly Instructions

R10-702 • R10-707

Magma® Rock 'n Roll™ Boat Stabilizer System

**NOTE:** For boats up to 40,000 lb. displacement one Rock 'n Roll Stabilizer is recommended. For boats over 40,000 lb. or in situations where more stabilization is required, we recommend two stabilizers.

**! THESE INSTRUCTIONS COVER STEPS ON INSTALLING THE ROCK 'N ROLL™ BOAT STABILIZER TO A MAGMA OUTRIGGER OR BOOM/POLE. FOR BOOM/POLE INSTALLATION, PLEASE SKIP TO STEP 8 ON PAGE 3.**

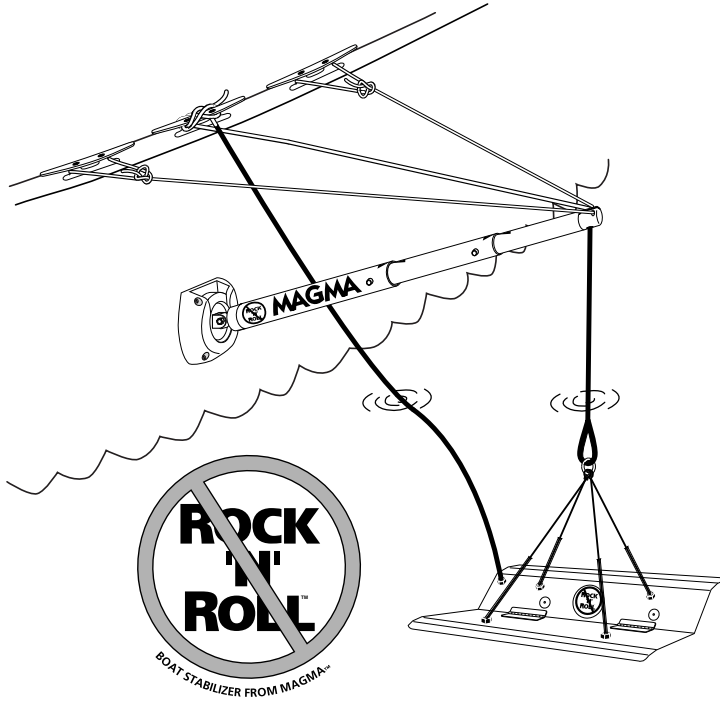

### Tools Required



### Materials Required

Fasteners (4)



### Contents of R10-707

If Purchased



United States Patent No. 5,263,434

### Contents of R10-702

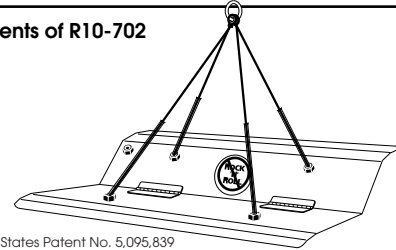

United States Patent No. 5,095,839

- 1** Outrigger will be suspended from two cleats "A & B" (Minimum 3' (1M) apart/maximum 16' (5M) apart and a third cleat "C" centered between "A & B."

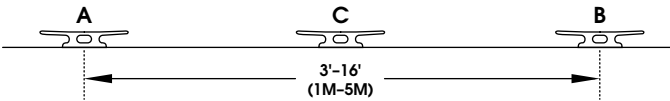

- 3** Apply marine bedding compound between **boot** and **hull** (Sikaflex 231 or equivalent).

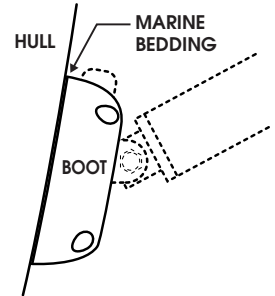

- 2** Mount **boot** using appropriate fasteners near the bulkhead. Consult your boat manufacturer or local shipyard repair facility for mounting advise on permanent hull attachments. Position boot by referring to illustrations in Steps 2, 3, & 4.

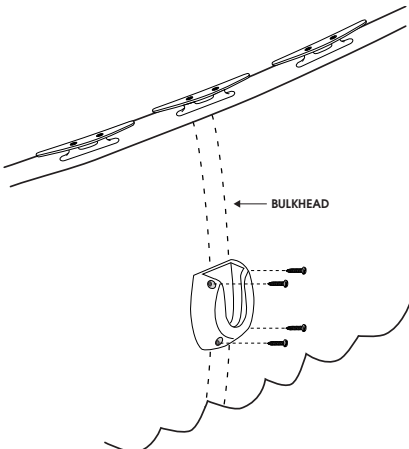

- 4** Position **boot** as shown for optimal operation of the Stabilizer/Outrigger System.

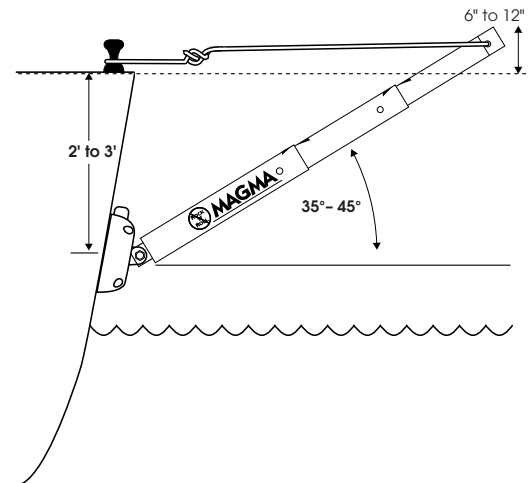

5

Cleat off **inboard lines** at cleats "A & B." so that hull pad remains 2' (60 cm) — 3' (90 cm) below the rail and is centered between cleats "A & B." Magma recommends that a bowline knot (see Step 6) be used on all cleats.

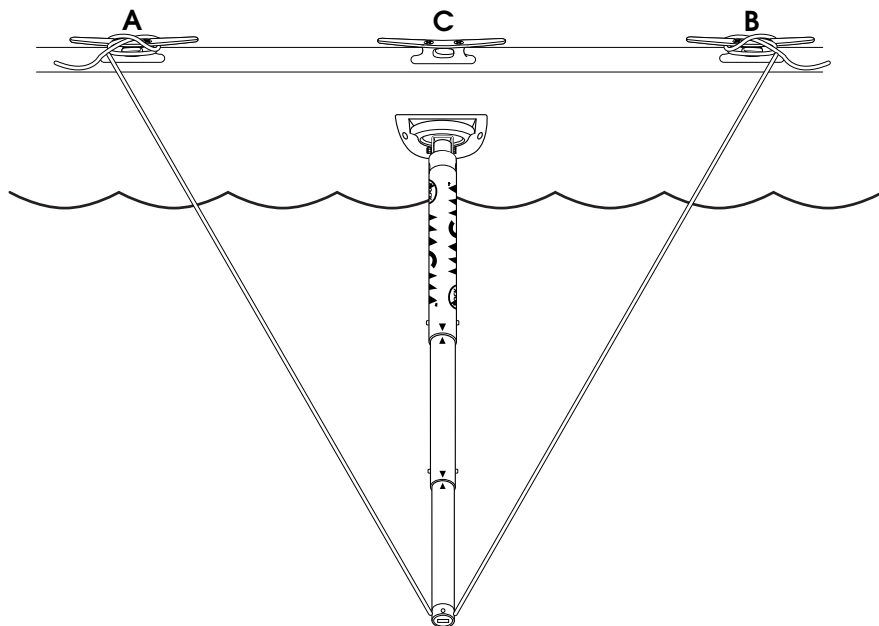
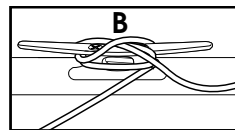
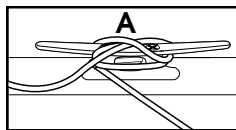

6 Tying a bowline knot.

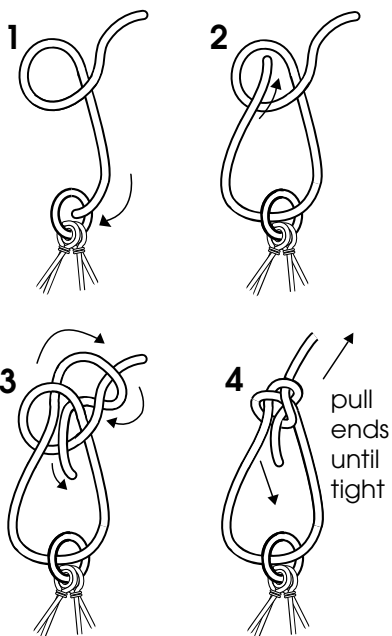

7

Connect all outrigger sections with spring pins so alignment arrows face up and towards each other.

- Set and adjust bowlines so **Outrigger** is perpendicular to hull.
- **Hull pad** rests in **boot** and outrigger angles upward.
- Outboard end of outrigger should be above rail

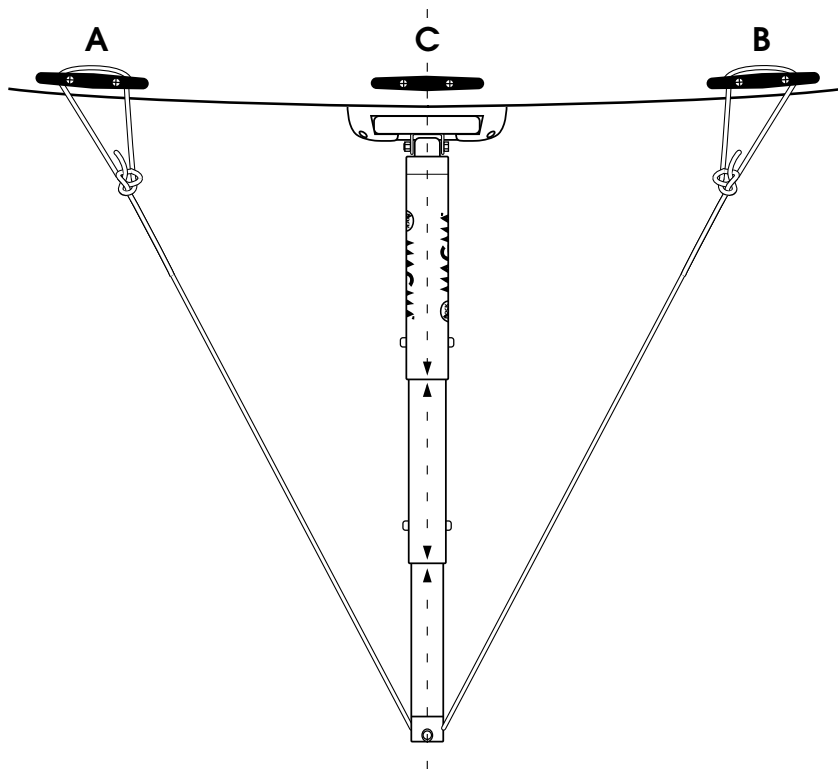

- 8** Handle stabilizer with bridle ring **1** to prevent possible injury from pinching action between the stops **2** of the stabilizer wings.

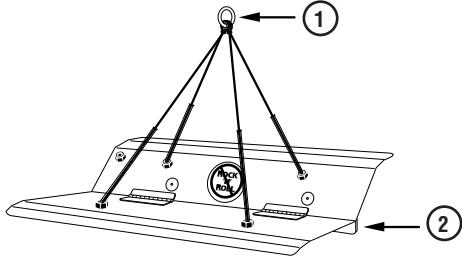

- 9** Insert **retrieval line** through the attachment hole by entering from top. Tie a figure 8 knot below leaving a 4" (10cm) tail and tie an additional single knot on the end for security as shown. Cleat off other end of line to center cleat "C."

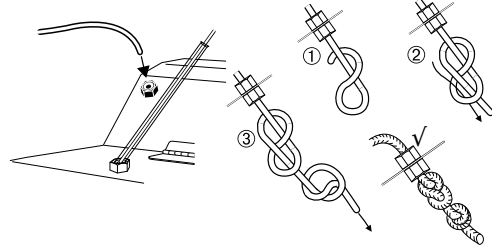

- 10** Attach sacrificial zincs (not included) through holes as shown.

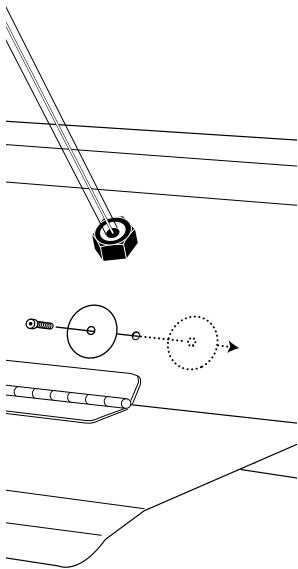

- 11** Attach a **depth control line** using a bowline knot passing through bridle ring of stabilizer making sure bridle lines are not crossed. Inspect for line wear before each use.

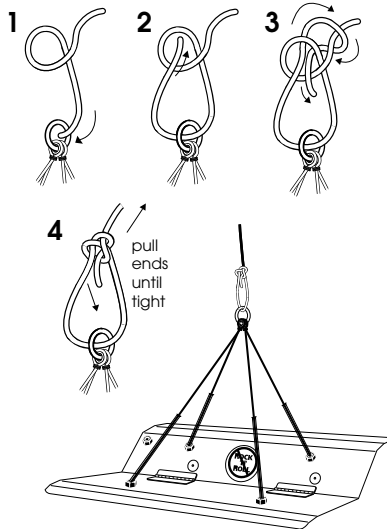

**NOTE:** Ensure **depth control line** is long enough to allow stabilizer to be pulled completely into the boat using the **retrieval line**.

- 12** Thread other end of **depth control line** up through underside of outboard end of Magma Outrigger, boom, or pole and cleat off at center cleat.

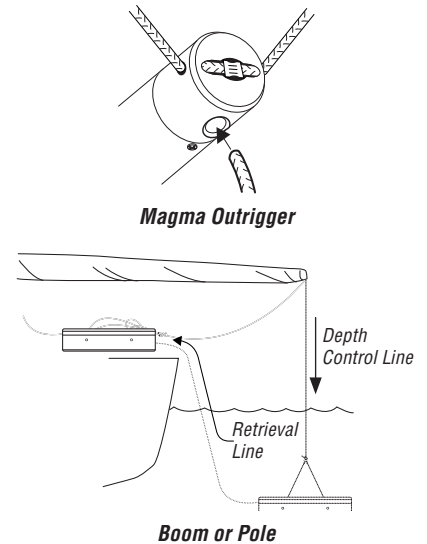

**NOTE:** Ensure **depth control line** is long enough to allow stabilizer to be pulled completely into the boat using the **retrieval line**.

- 13** Using the **depth control line**, adjust depth of a stabilizer so bridle ring of stabilizer is at least 10' (3M) below water surface, preferably 15' to 20' deep, and cleat off at center cleat.

**NOTE:** Stabilizer should never touch the ocean floor.

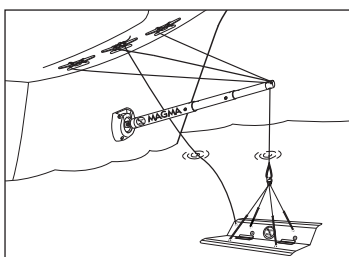
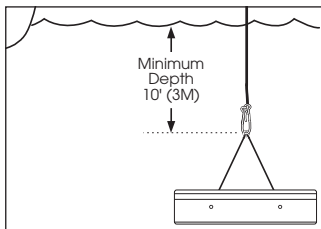

**Magma Outrigger**

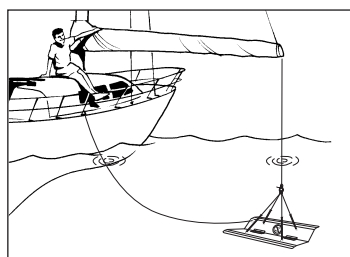

**Boom or pole**

- 14** For best performance, **retrieval line** should be adjusted tight enough so that the stabilizer remains 6–8 feet from hull but not so tight as to inhibit stabilizer action.

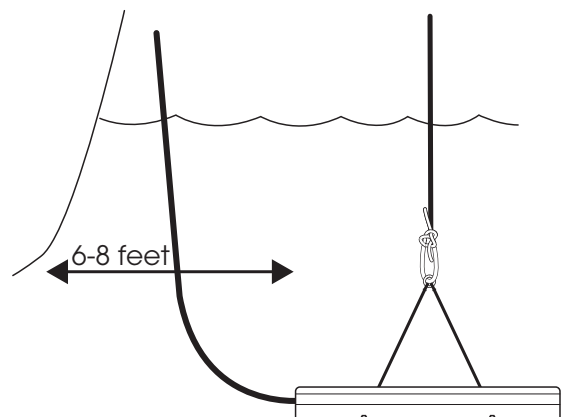

**15** Correct positioning from hull.

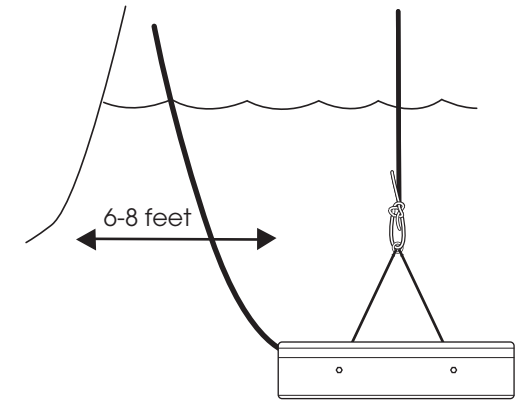

■ Incorrect positioning from hull

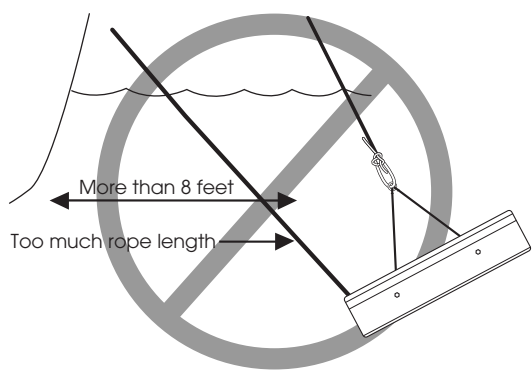

**16** Before cutting any lines, allow at least 2' (60 cm) extra line. Then tape, cut, and burn.

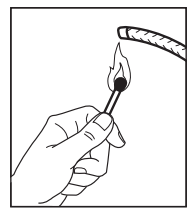
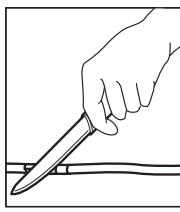
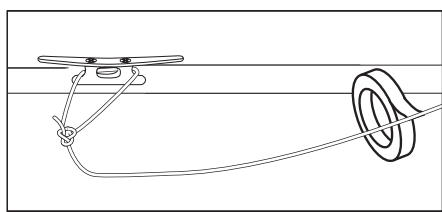
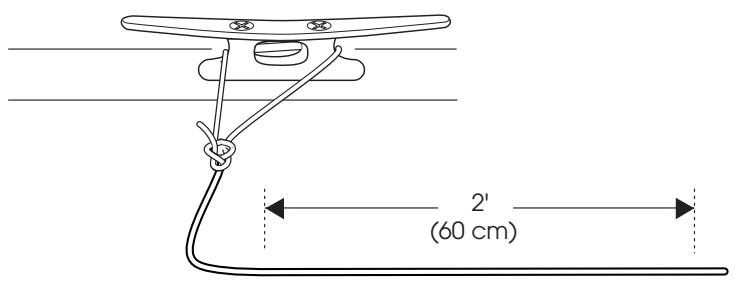

**HELPFUL HINTS**

- If lines rub on rail, use chafe guards
- Rinse with fresh water before stowing
- Leave all lines preset, coil individually with rubber bands
- Stow in bag as shown

