

NEXTECH



1080p GPS Dash Camera

User Manual

1. ABOUT THE PRODUCT

This product is not guaranteed to record ALL events. Use this product only for reference when investigating incidents or road accidents. The device may not properly record accidents, it only operated by a range of impact. Ensure completely turned on the recorder, then video recording and event recording will available.

Nextech is not responsible for any loss caused by an accident, nor is it responsible for providing any support regarding the outcome of an accident.

2. PRODUCT STRUCTURE AND INSTRUCTIONS

1. Charging port on suction cup
2. Camera Lens
3. LCD Display
4. Reset
5. USB/Charging Port
6. SD card slot
7. Menu/Back
8. Left
9. OK
10. Locked Video/ Right
11. Power/Mode
12. LED Indicator
13. Microphone
14. Speaker

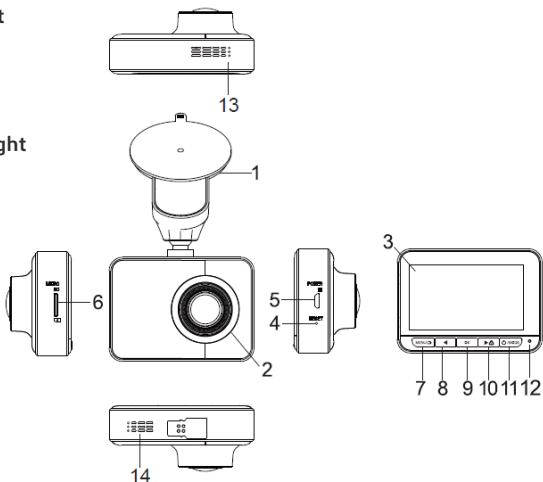

MENU/Back

Press  button to enter Menu selection during standby mode, to press the back button to back to the video standby mode.

Left

Press  button to move to the last selections during menu setting or file selection. Press the left button to turn on /off the voice recording during video standby or video recording mode.

OK

Press  to confirm current selection. In standby mode, press OK to start to record video.

Emergency Recording/Forward

Press  button to enter emergency recording mode during video recording, the video will not be covered by loop recordings, and the Lock icon will be showed in the right corner of LCD display. Press the Forward button to move to the next steps during menu setting or file selection.

POWER/MODE

Quick press  button to start up the camera. Camera will start recording automatically with SD-card already inserted in.

Long press the power button for 2 seconds to turn off the device.

Short press the Mode button to enter into camera/ video recording/ video playback in standby mode.

3. PRODUCT FUNCTIONS

Video Recording

Insert SD card to the product and get power from car charger, the machine start recording automatically, click OK button to stop recording.

Video playback

Press Mode button to review photos, Press Menu to select emergency or loop recording video and press back button to review.

USB connection

To Connect the camera with computer through micro USB port, you can easily review the photos/videos on your computer.

G-sensor

The machine has built-in G-sensor, it will lock the video automatically during vehicle collision, the locked video won't be covered, and the locked icons shows in the right corner of the LCD display screen.

Parking monitor

In shutdown mode, when the machine detected vibration, It gets into video recording and locked the current file, It will be shutdown automatically after 30 seconds if without any operation.

Loop recording

Overwrites existing files and records in either 1/3/5 minutes blocks.

Record audio

Close or open audio recording in video file.

GPS Location

Install the GPS Media player on your computer, so you can review GPS location is shown in the top right hand corner and the speed is also shown at the bottom.

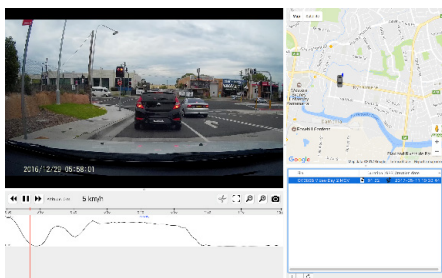

WIFI Connection

1. To get the Nextech Dashcam App from App Store or Google Play, make sure the dashcam is turned on for Wi-Fi connection. Dash Camera's WIFI default passcode is 123456789.
2. The Wi-Fi symbol icon  should appear green in the middle of right hand corner of the dashcam LCD screen.
3. Once you have downloaded and installed the app, open it and the following screen should display:
4. Press the "Add New Device" button to start connection with the dash camera.

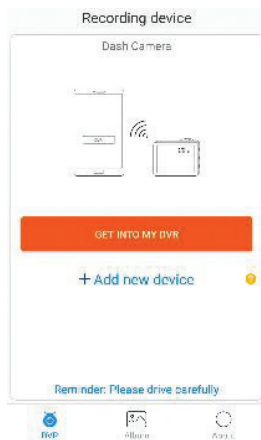

5. You will see a DVR devices list displayed, click on the dash camera labelled as QV-3848. **Note:** If the device is not displaying in this list, ensure the camera & Wi-Fi are both turned on.

6. The connection process may take around 3-20 seconds depending on if your Wi-Fi connection is enabled or not.

7. An Enhanced video preview message will appear; it is suggested to turn off the Bluetooth from your smartphone to make the video playback more stable.

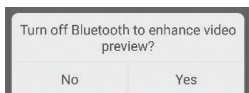

8. Once the connection is successful, the video will now be streaming. Also you will have such options as to capture video, images or playback existing video.

9. Once you have already added your dash camera to the app; you may gain quick access to the dash camera by pressing the "Get Into My DVR" button located on the main page of the app.

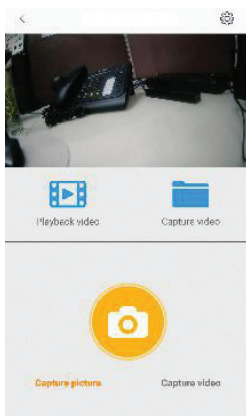

4. PRODUCT SPECIFICATION

Display:	2.7" LCD
Video Resolution:	1080p (1920 x 1080), 720p (1280 x 720)
Image Resolution:	2MP
Frame Rate:	30fps
Lens Angle:	140°
Video Compression:	H.264
Video File Format:	MOV
Storage:	Up to 64GB microSD
Battery:	Li-Ion 3.7V, 300mAh
Power:	5VDC @ 1.5A
Car Charger Voltage Input:	12-36VDC
Dimensions:	76(W) x 55(H) x 34(D)mm (Excluding Mount)

5. WARNING

- Do not expose the product to direct sunlight or intense light. Such damages are not covered by the warranty.
- Frequently check the product for the proper installation position. Impact caused by extreme road conditions may alter the installation position. Ensure that the product is positioned as instructed in this guide.
- Do not use chemical cleaners or solvents to clean the product.
- Do not disassemble the product or subject the product to impact.
- This device is designed to record video while the vehicle is in operation. The quality of the video might be affected by weather conditions and the road environment, such as whether it is day or night, presence of street lighting, entering/exiting tunnels, and the surrounding temperature.
- This device is intended to be used inside the vehicle only.

6. DRIVING AND PRODUCT OPERATION

1. Do not operate the product while driving a vehicle. Distraction while driving may cause accidents and result in injury or death.
2. Install the product in places where the driver's view is not obstructed. Obstruction of the driver's vision may cause accidents and result in injury or death. Check with your state and municipal laws before mounting the product to the windshield.

7. POWER SUPPLY

Connect the car adapter's mini USB plug to mini USB port in suction cup. Connect the cigarette lighter adapter plug to the vehicle's cigarette lighter port. It is suggested to wire the cable along with your windscreen.

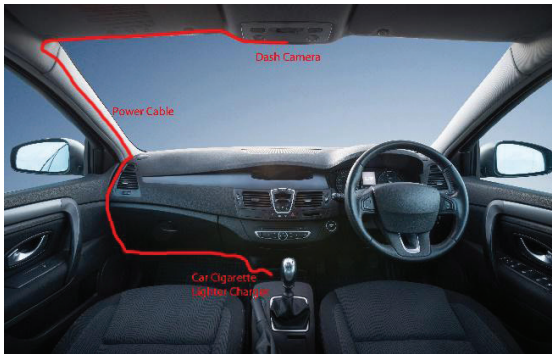

In certain models of cars, the cigarette lighter keeps providing power even when the engine is off. Be sure to remove the car charger or disconnect the device when leaving the vehicle to prevent draining the vehicle battery. Check your vehicle's owner's manual to determine if this applies to your vehicle

8. INSTALLATION:

1. Fix the windscreen charging mount to the top of your windscreen, it is suggested towards the middle position of your windscreen.
2. Peel off the adhesive sticker located on the top of the windscreen charging mount once you have the desired location and stick on your windscreen.
3. Attach the dash camera to the windscreen charging mount by the magnet and adjust to the correct position facing forward.

Note: It is recommended to place the dash camera behind the rear vision mirror to prevent the camera from obstructing your view while driving.