

SoundPlus® Infrared Emitter • Model WIR TX9



Description:

The TX9 emitter produces a wide-angle infrared signal that concentrates the IR energy efficiently in the listening area. Operating on the 2.3-3.3 MHz bandwidth, the TX9 is less susceptible to radio and lighting interference. Each TX9 emitter can cover up to 28,000 sq ft (2,600 sq m) in single-channel operation. The coverage area can be easily increased by daisy-chaining additional TX9 emitters. A wall/ceiling omnidirectional mount is included and stand kits are available for portable operation.

Applications:

- Simultaneous Interpretation • Audio Description • Conferences
- Multi-Media Rooms • Boardrooms • Courtrooms • Schools
- Universities • Cinemas • Churches

Models:

WIR TX9	(N. AMERICA)
WIR TX9-01	(EUROPE)
WIR TX9-02	(UK)

WIR TX9 Emitter:

Dimensions, Weight:	11.25" W x 6.25" H x 2.125" D (28.6 cm x 15.9 cm x 5.4 cm), 1.9 lbs (0.9 kg)
Color:	Black with white legends, red acrylic lens
Power Supply:	Wall Transformer, 24 VAC, 50-60Hz, 35 VA, 3-pin MOLEX Connector North America: TFP 010, UL/CSA Europe: TFP 027-01, 2-pin Schuko plug, CE UK: TFP 027-02, 3-pin UK plug, CE Note: Each WIR TX9 requires its own power supply
Power Cable:	NEC Class 2 wiring, two-conductor, 18 ga, 200' (61m) max. length
Indicators:	Green LED power indicator, red LED baseband indicator
Carrier Frequency:	50 kHz to 8 MHz
Emitter IR Power:	3.5 watts
Coverage Area:	Up to 28,000 ft ² (2,600 m ²) in single-channel mode when using the RX22-4 or RX12-4 Receiver Up to 18,000 ft ² (1,700 m ²) in two-channel mode when using the RX22-4 or RX12-4 Receiver Up to 3,500 ft ² (325 m ²) in single-channel mode when using the RX14-2 Receiver Up to 3,063 ft ² (285 m ²) in single-channel mode when using the RX18 Receiver (See coverage area diagrams)
Baseband Input:	BNC, 100 mV per carrier, 50 Ω, for use with WIR TX9 or MOD 232 only
Baseband Output:	BNC, 50 Ω, for use with TX9 only
Baseband Cable:	RG 58 Coax, BNC connectors, maximum 1000' (300m) length
Operating Requirements:	0-50° C ambient temperature, non-condensing, non-corrosive atmosphere
Mounting Kits:	Wall or Ceiling Mount: BKT 024 Omnidirectional mount, Mic Stand Kit: SS-11 or SS-6
Warranty:	5 years on emitter, 90 days on accessories
Approvals:	CE, FCC, RoHS, WEEE
Compatible Receivers:	WIR RX12-4 Four-Channel Receiver, RX14 Stereo Receiver, RX18 Two-Channel Receiver

Fig. 1: WIR TX9 Rear Panel

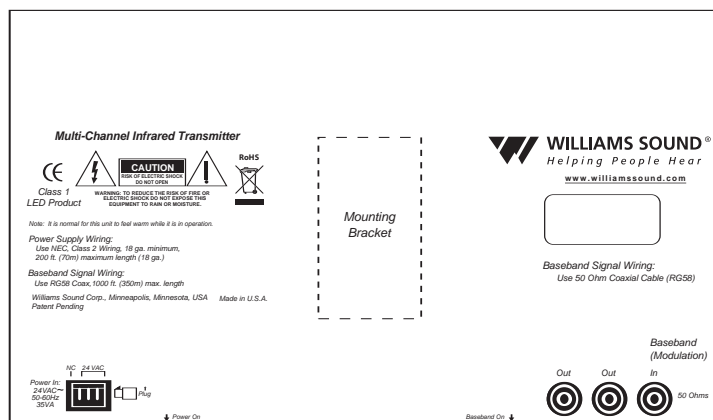

*SPECIFICATIONS SUBJECT TO CHANGE WITHOUT NOTICE

SoundPlus® Infrared Emitter • Model WIR TX9



SoundPlus® Infrared Emitter • Model WIR TX9

Coverage Patterns:

Fig. 2: Receiver Coverage Area with TX9 Emitter in Single Channel Mode

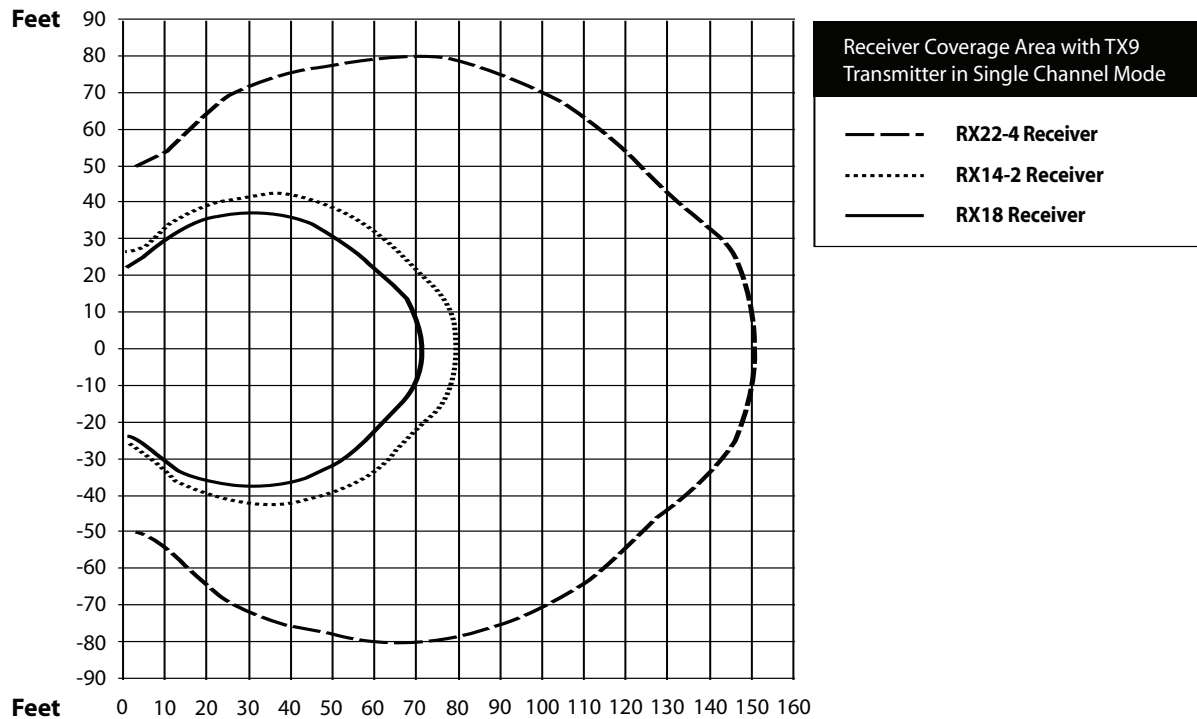

The coverage area for the TX9 will vary depending on the receiver being used. The diagram above demonstrates the receiver coverage when operating a single TX9 emitter in single channel mode. Patterns are direct radiation patterns.

Note: Reflections of the infrared light from walls, ceilings and floors may change these patterns.

*SPECIFICATIONS SUBJECT TO CHANGE WITHOUT NOTICE

SoundPlus® Infrared Emitter • Model WIR TX9



SoundPlus® Infrared Emitter • Model WIR TX9

Fig. 3: 3-Dimension Foot Pattern

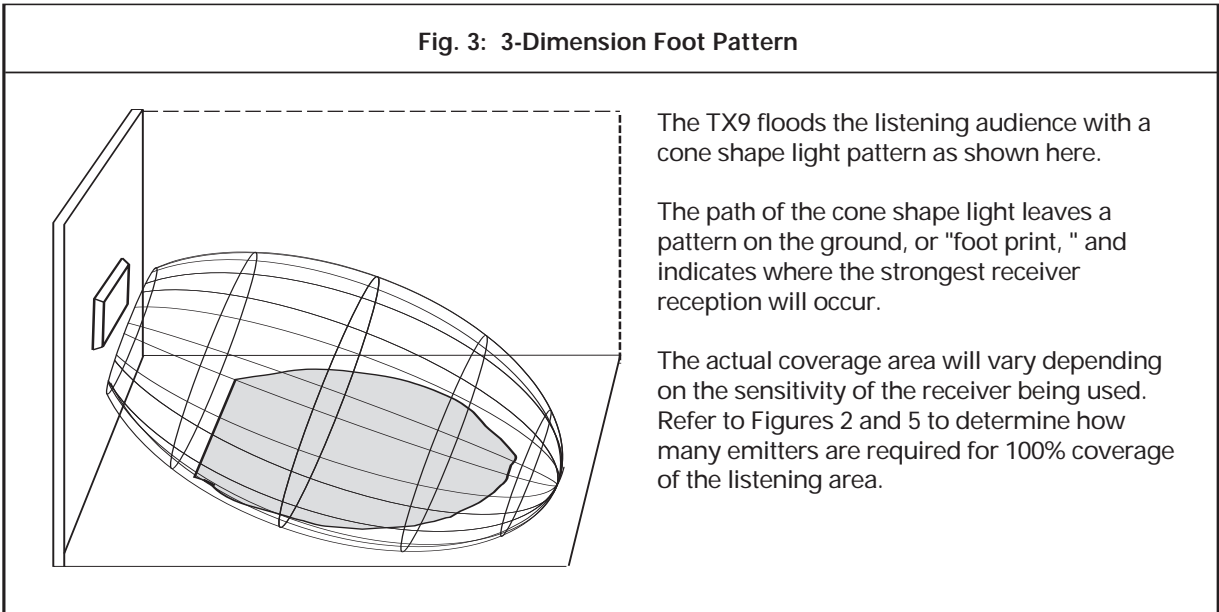

To determine the best location for the emitter, it helps to think of the IR emitter as an invisible flood-light. You'll want to aim it so the listeners are "flooded" with the infrared light. The emitter should also be positioned high enough so it won't be blocked by people and other physical obstructions. See Figure 4 below. Mount the emitter at least 2 ft. (.61 m) above the audience. Position the emitter to face in a slightly downward angle, 20°, that will increase the "throw" of the infrared beam.

Fig. 4 Vertical Beam Spread

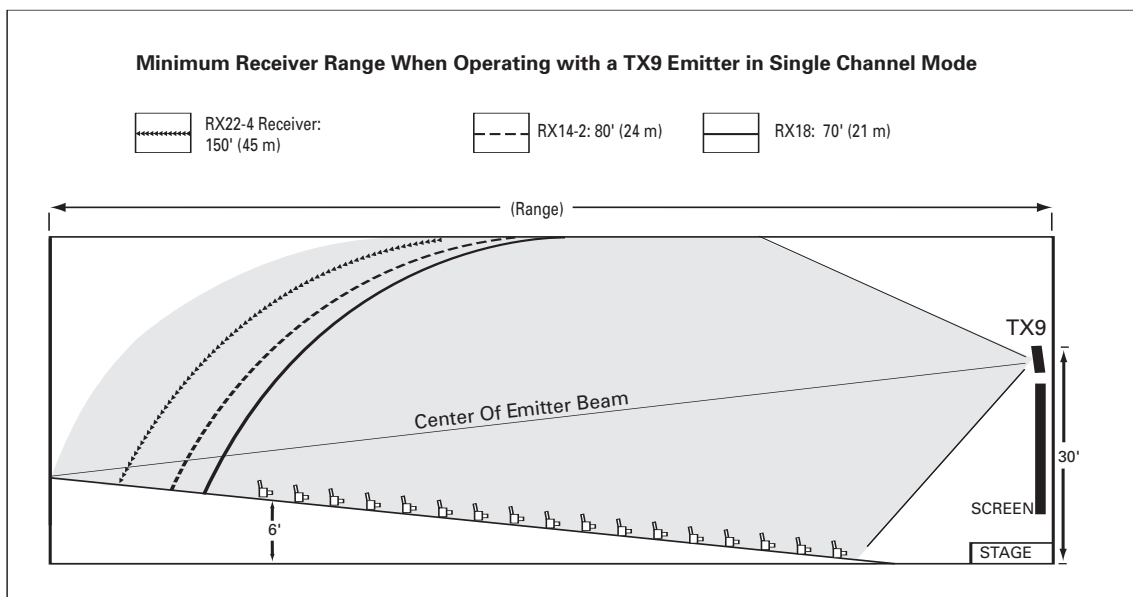

*SPECIFICATIONS SUBJECT TO CHANGE WITHOUT NOTICE

SoundPlus® Infrared Emitter • Model WIR TX9



SoundPlus® Infrared Emitter • Model WIR TX9

Maximum Range When Using the RX22-4 or RX12-4 Infrared Receiver

Fig. 5: Horizontal and Vertical Radiation Polar Plots

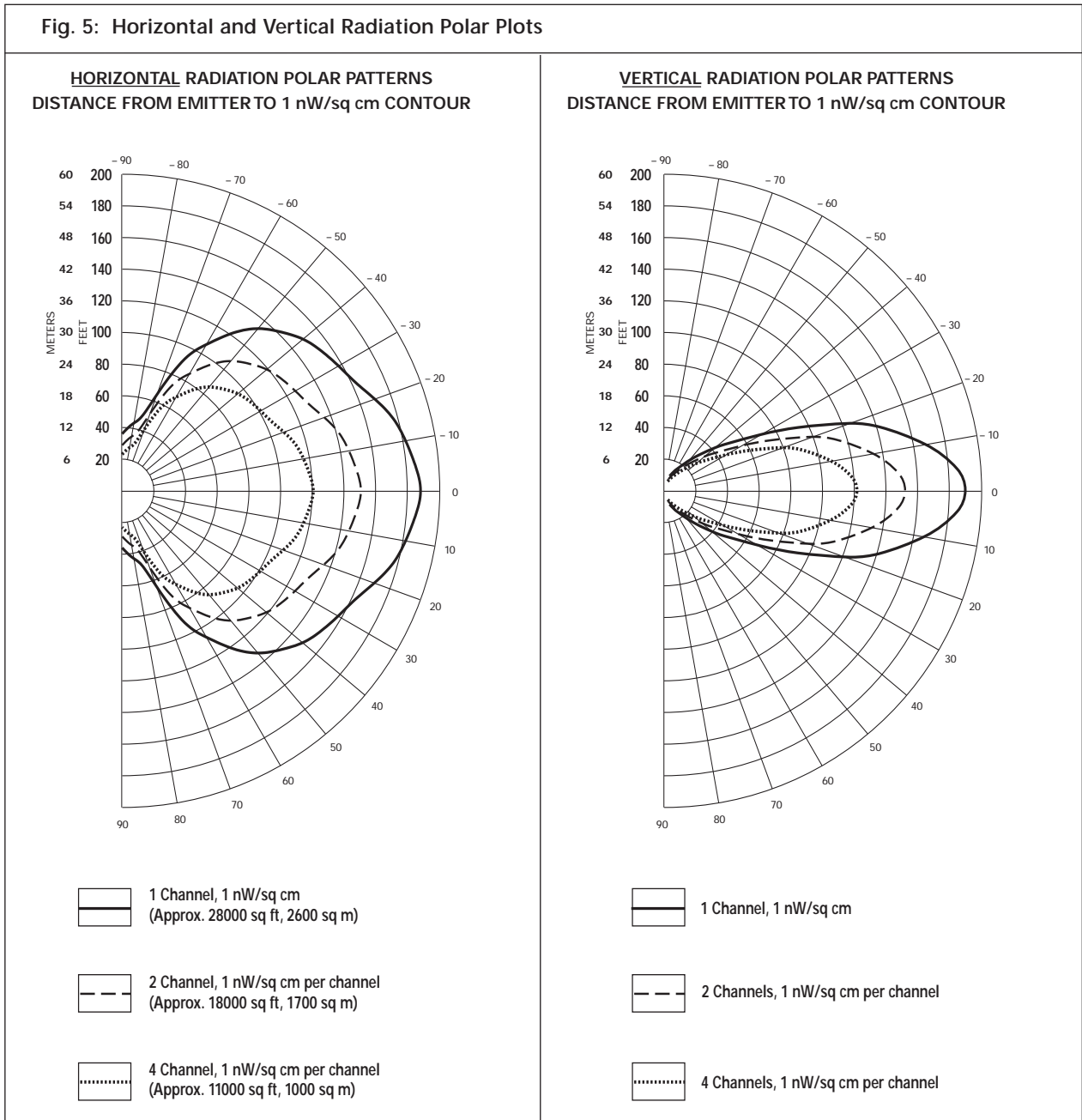

Reflections of the infrared light from walls, ceilings, and floors may change these patterns. Important: Remember to point the emitter towards the listening audience!

If you're not getting sufficient coverage with a single, properly installed TX9 Emitter, you may need to add additional WIR TX9 Emitters to achieve full coverage of your listening area. Figures 6a and 6b illustrate how multiple emitters can be used for large room installations.

*SPECIFICATIONS SUBJECT TO CHANGE WITHOUT NOTICE

SoundPlus® Infrared Emitter • Model WIR TX9



SoundPlus® Infrared Emitter • Model WIR TX9

Multiple Emitters Installed to Maximize Coverage

Fig. 6a: Overlapping Illumination Patterns to Cover Larger Listening Areas

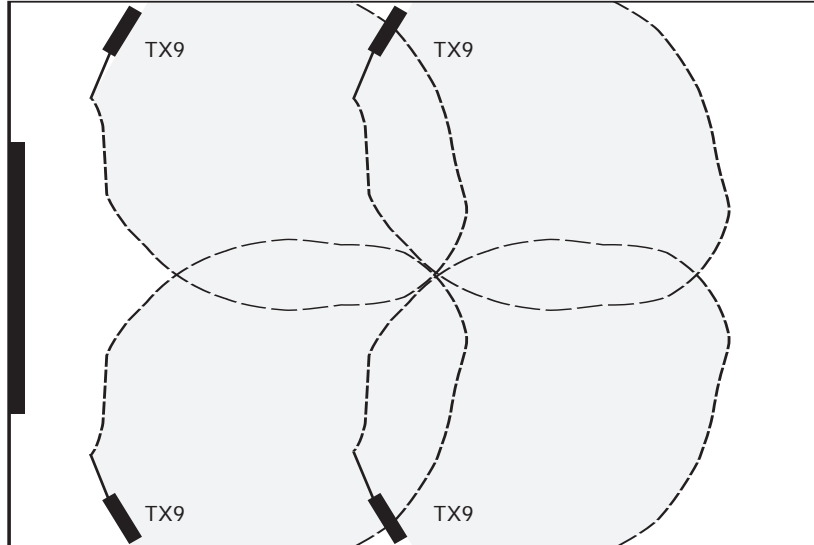
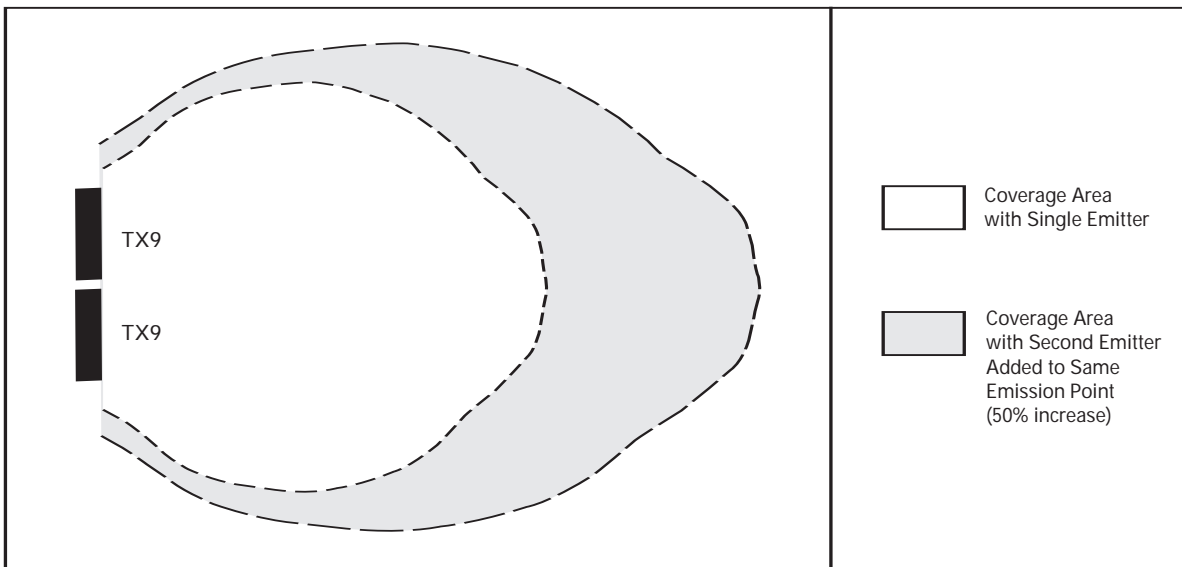

Fig. 6a above is a typical example of how multiple emitters are used to cover larger listening areas. Generally it is desirable for the illumination patterns to overlap. Note: The coverage area will vary depending on the infrared receiver being used; refer to Figures 2 and 5 to determine how many emitters are required to achieve full coverage of a listening area.

Fig. 6b: Overlapping Illumination Patterns to Cover Larger Listening Areas



When two emitters are used at the same emission point in single channel mode, the overall coverage area increases 50%. When using an RX22-4 or RX12-4 receiver, as a result, the coverage area will increase to an estimated 42,000 ft² (3,902 m²); the RX14-2 will increase to 5,250 ft² (488 m²); the RX18 will increase to 4,590 ft² (426 m²).

*SPECIFICATIONS SUBJECT TO CHANGE WITHOUT NOTICE

SoundPlus® Infrared Emitter • Model WIR TX9



Bid Specs:

The emitter shall be contained in a metal enclosure with a shatter-resistant lens. The emitter shall include an omni-directional mounting bracket for permanent installation and a bracket shall be available for mounting on a floor stand for portable installations. Each emitter shall be powered by a 24 VAC, 50 VA, 50-60 Hz power supply. The power connector shall be a 3-pin Molex-type. The emitter shall have a BNC-type 50 ohm baseband input and a BNC-type baseband 50 ohm output jack. The emitter shall have a repeater circuit to allow multiple numbers of emitters to operate from the baseband signal. The emitter shall have a visible LED indicator for power and for baseband signal. Carrier frequency is 50KHz to 8 MHz. The emitter shall shut off when the baseband signal is not present. The emitter shall provide an effective coverage area of up to 28,000 sq ft (2,600 sq m) in single-channel mode and up to 18,000 sq ft (1,700 sq. m) in two-channel mode when using the RX22-4, RX12-4 or RX18 receivers. The emitter shall be convection-cooled, without fans. The emitter shall have CE, FCC, RoHS, and WEEE approval and carry a five-year warranty on parts and labor.

The emitter shall be Williams Sound Corp. model WIR TX9.

*SPECIFICATIONS SUBJECT TO CHANGE WITHOUT NOTICE

SoundPlus® Infrared Emitter • Model WIR TX9



SoundPlus® Infrared Emitter • Model WIR TX9

Contact:

United States

Williams Sound Corp.
10321 W. 70th Street
Eden Prairie, MN 55344
Ph: 800-328-6190 / 952-943-2252
FAX: 952-943-2174
Web: www.williamssound.com
Email: info@williamssound.com

Canada

Thorvin Electronics
2861 Sherwood Heights Dr. Units 36-37
Oakville, ON L6J-7K1 Canada
Ph: 800-323-6634 / 905-829-3040
FAX: 905-829-4196
Web: www.thorvinelectronics.com

United Kingdom

Sound Associates
Keeble House, 81 Island Farm Road
West Molesey, Surrey KT 2SA
United Kingdom
Ph: (44) 020 8939 5900
Fax: (44) 020 8939 5901
Email: jmurdoch@soundassociates.co.uk
Web: www.soundassociates.com

Asia, Australia, Latin America, Middle East, South Africa

International Sales Department
Williams Sound Corp.
10321 W. 70th Street
Eden Prairie, MN 55344 USA
Phone: +1 952 224 7791 or +1 651 493 2578
Fax: +1 952 943 2174
Email: info@williamssound.com
Web: www.williamssound.com

*SPECIFICATIONS SUBJECT TO CHANGE WITHOUT NOTICE